

TOSHIBA

SERVICE MANUAL

AIR-CONDITIONER MULT TYPE

<High Wall Types>

MMK-UP0051DHPL-E(TR)

MMK-UP0071DHPL-E(TR)

MMK-UP0091DHPL-E(TR)

MMK-UP0121DHPL-E(TR)

MMK-UP0151DHPL-E(TR)

MMK-UP0181DHPL-E(TR)

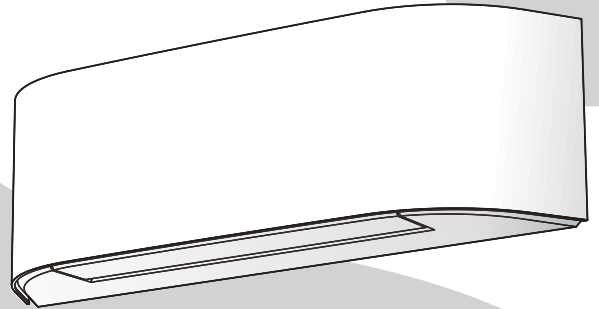

R32 or R410A

March, 2023

Original instruction

Please read this Installation Manual carefully before installing the Air Conditioner.

- This Manual describes the installation method of the indoor unit.
- For installation of the outdoor unit, follow the Installation Manual attached to the outdoor unit.

ADOPTION OF R32 or R410A REFRIGERANT

This Air Conditioner has adopted a refrigerant HFC (R32 or R410A) which does not destroy the ozone layer.

Be sure to check the refrigerant type for outdoor unit to be combined, and then install it.

Information

If U series models (TU2C-Link) are combined with models other than U series (TCC-Link), the wiring specifications and maximum number of connectable indoor units will be changed. Pay attentions to their communication specifications when carrying out the installation, maintenance, or repair. For its details, refer to the "Electrical connection" in this Manual.

Product information of ecodesign requirements. (Regulation (EU) 2016/2281)

<http://ecodesign.toshiba-airconditioning.eu/en>

CONTENTS

PRECAUTION FOR SAFETY	6
NEW REFRIGERANT (R32 or R410A)	12
1. SPECIFICATIONS	14
2. CONSTRUCTION VIEWS (EXTERNAL VIEWS)	16
3. WIRING DIAGRAM	17
4. PARTS RATING.....	18
5. REFRIGERANTING CYCLE DIAGRAM	19
6. CONTROL OUTLINE	20
7. CONFIGURATION OF CONTROL CIRCUIT	28
8. APPLIED CONTROL	37
9. TROUBLESHOOTING	62
10. INSTALLATION MANUAL	90
11. HOW TO REPLACE MAIN PARTS	143
12. REPLACEMENT OF P.C. BOARD FOR INDOOR UNIT SERVICING	160
13. EXPLODED VIEWS AND PARTS LIST	164

Please read carefully through these instructions that contain important information which complies with the “Machinery” Directive (Directive 2006/42/EC), and ensure that you understand them.

Definition of Qualified Installer or Qualified Service Person

The air conditioner must be installed, maintained, repaired and removed by a qualified installer or qualified service person. When any of these jobs is to be done, ask a qualified installer or qualified service person to do them.

A qualified installer or qualified service person is an agent who has the qualifications and knowledge described in the table below.

Agent	Qualifications and knowledge which the agent must have
Qualified installer (*1)	<ul style="list-style-type: none"> • The qualified installer is a person who installs, maintains, relocates and removes the air conditioners made by Toshiba Carrier Corporation. He or she has been trained to install, maintain, relocate and remove the air conditioners made by Toshiba Carrier Corporation or, alternatively, he or she has been instructed in such operations by an individual or individuals who have been trained and is thus thoroughly acquainted with the knowledge related to these operations. • The qualified installer who is allowed to do the electrical work involved in installation, relocation and removal has the qualifications pertaining to this electrical work as stipulated by the local laws and regulations, and he or she is a person who has been trained in matters relating to electrical work on the air conditioners made by Toshiba Carrier Corporation or, alternatively, he or she has been instructed in such matters by an individual or individuals who have been trained and is thus thoroughly acquainted with the knowledge related to this work. • The qualified installer who is allowed to do the refrigerant handling and piping work involved in installation, relocation and removal has the qualifications pertaining to this refrigerant handling and piping work as stipulated by the local laws and regulations, and he or she is a person who has been trained in matters relating to refrigerant handling and piping work on the air conditioners made by Toshiba Carrier Corporation or, alternatively, he or she has been instructed in such matters by an individual or individuals who have been trained and is thus thoroughly acquainted with the knowledge related to this work. • The qualified installer who is allowed to work at heights has been trained in matters relating to working at heights with the air conditioners made by Toshiba Carrier Corporation or, alternatively, he or she has been instructed in such matters by an individual or individuals who have been trained and is thus thoroughly acquainted with the knowledge related to this work.
Qualified service person (*1)	<ul style="list-style-type: none"> • The qualified service person is a person who installs, repairs, maintains, relocates and removes the air conditioners made by Toshiba Carrier Corporation. He or she has been trained to install, repair, maintain, relocate and remove the air conditioners made by Toshiba Carrier Corporation or, alternatively, he or she has been instructed in such operations by an individual or individuals who have been trained and is thus thoroughly acquainted with the knowledge related to these operations. • The qualified service person who is allowed to do the electrical work involved in installation, repair, relocation and removal has the qualifications pertaining to this electrical work as stipulated by the local laws and regulations, and he or she is a person who has been trained in matters relating to electrical work on the air conditioners made by Toshiba Carrier Corporation or, alternatively, he or she has been instructed in such matters by an individual or individuals who have been trained and is thus thoroughly acquainted with the knowledge related to this work. • The qualified service person who is allowed to do the refrigerant handling and piping work involved in installation, repair, relocation and removal has the qualifications pertaining to this refrigerant handling and piping work as stipulated by the local laws and regulations, and he or she is a person who has been trained in matters relating to refrigerant handling and piping work on the air conditioners made by Toshiba Carrier Corporation or, alternatively, he or she has been instructed in such matters by an individual or individuals who have been trained and is thus thoroughly acquainted with the knowledge related to this work. • The qualified service person who is allowed to work at heights has been trained in matters relating to working at heights with the air conditioners made by Toshiba Carrier Corporation or, alternatively, he or she has been instructed in such matters by an individual or individuals who have been trained and is thus thoroughly acquainted with the knowledge related to this work.

Definition of Protective Gear

When the air conditioner is to be transported, installed, maintained, repaired or removed, wear protective gloves and 'safety' work clothing.



In addition to such normal protective gear, wear the protective gear described below when undertaking the special work detailed in the table below.

Failure to wear the proper protective gear is dangerous because you will be more susceptible to injury, burns, electric shocks and other injuries.

Work undertaken	Protective gear worn
All types of work	Protective gloves 'Safety' working clothing
Electrical-related work	Gloves to provide protection for electricians Insulating shoes Clothing to provide protection from electric shock
Work done at heights (50 cm or more)	Helmets for use in industry
Transportation of heavy objects	Shoes with additional protective toecap
Repair of outdoor unit	Gloves to provide protection for electricians



The important contents concerned to the safety are described on the product itself and on this Service Manual. Please read this Service Manual after understanding the described items thoroughly in the following contents (Indications / Illustrated marks), and keep them.

[Explanation of indications]





Indication	Explanation
 DANGER	Indicates contents assumed that an imminent danger causing a death or serious injury of the repair engineers and the third parties when an incorrect work has been executed.
 WARNING	Indicates possibilities assumed that a danger causing a death or serious injury of the repair engineers, the third parties, and the users due to troubles of the product after work when an incorrect work has been executed.
 CAUTION	Indicates contents assumed that an injury or property damage (*) may be caused on the repair engineers, the third parties, and the users due to troubles of the product after work when an incorrect work has been executed.

* Property damage: Enlarged damage concerned to property, furniture, and domestic animal / pet

[Explanation of illustrated marks]

Indication	Explanation
	Indicates prohibited items (Forbidden items to do) The sentences near an illustrated mark describe the concrete prohibited contents.
	Indicates mandatory items (Compulsory items to do) The sentences near an illustrated mark describe the concrete mandatory contents.
	Indicates cautions (Including danger / warning) The sentences or illustration near or in an illustrated mark describe the concrete cautious contents.















MEANING OF SYMBOLS DISPLAYED ON THE UNIT

	WARNING (Risk of fire)	This mark is for R32 refrigerant only. Refrigerant type is written on nameplate of outdoor unit. In case that refrigerant type is R32, this unit uses a flammable refrigerant. If refrigerant leaks and comes in contact with fire or heating part, it will create harmful gas and there is risk of fire.
		Read the OWNER'S MANUAL carefully before operation.
		Service personnel are required to carefully read the OWNER'S MANUAL and INSTALLATION MANUAL before operation.
		Further information is available in the OWNER'S MANUAL, INSTALLATION MANUAL, and the like.

Warning Indications on the Air Conditioner Unit

[Confirmation of warning label on the main unit]





Confirm that labels are indicated on the specified positions
 If removing the label during parts replace, stick it as the original.

Warning indication	Description				
<table border="1" style="width: 100%;"> <tr> <td style="width: 20%; text-align: center;"></td> <td style="text-align: center;">WARNING</td> </tr> <tr> <td></td> <td>ELECTRICAL SHOCK HAZARD Disconnect all remote electric power supplies before servicing.</td> </tr> </table>		WARNING		ELECTRICAL SHOCK HAZARD Disconnect all remote electric power supplies before servicing.	<p>WARNING</p> <p>ELECTRICAL SHOCK HAZARD Disconnect all remote electric power supplies before servicing.</p>
	WARNING				
	ELECTRICAL SHOCK HAZARD Disconnect all remote electric power supplies before servicing.				
<table border="1" style="width: 100%;"> <tr> <td style="width: 20%; text-align: center;"></td> <td style="text-align: center;">WARNING</td> </tr> <tr> <td></td> <td>Moving parts. Do not operate unit with grille removed. Stop the unit before the servicing.</td> </tr> </table>		WARNING		Moving parts. Do not operate unit with grille removed. Stop the unit before the servicing.	<p>WARNING</p> <p>Moving parts. Do not operate unit with grille removed. Stop the unit before the servicing.</p>
	WARNING				
	Moving parts. Do not operate unit with grille removed. Stop the unit before the servicing.				
<table border="1" style="width: 100%;"> <tr> <td style="width: 20%; text-align: center;"></td> <td style="text-align: center;">CAUTION</td> </tr> <tr> <td></td> <td>High temperature parts. You might get burned when removing this panel.</td> </tr> </table>		CAUTION		High temperature parts. You might get burned when removing this panel.	<p>CAUTION</p> <p>High temperature parts. You might get burned when removing this panel.</p>
	CAUTION				
	High temperature parts. You might get burned when removing this panel.				
<table border="1" style="width: 100%;"> <tr> <td style="width: 20%; text-align: center;"></td> <td style="text-align: center;">CAUTION</td> </tr> <tr> <td></td> <td>Do not touch the aluminum fins of the unit and ionizer PIN of Air purifier. Doing so may result in injury.</td> </tr> </table>		CAUTION		Do not touch the aluminum fins of the unit and ionizer PIN of Air purifier. Doing so may result in injury.	<p>CAUTION</p> <p>Do not touch the aluminium fins of the unit and ionizer PIN of Air purifier. Doing so may result in injury.</p>
	CAUTION				
	Do not touch the aluminum fins of the unit and ionizer PIN of Air purifier. Doing so may result in injury.				
<table border="1" style="width: 100%;"> <tr> <td style="width: 20%; text-align: center;"></td> <td style="text-align: center;">CAUTION</td> </tr> <tr> <td></td> <td>BURST HAZARD Open the service valves before the operation, otherwise there might be the burst.</td> </tr> </table>		CAUTION		BURST HAZARD Open the service valves before the operation, otherwise there might be the burst.	<p>CAUTION</p> <p>BURST HAZARD Open the service valves before the operation, otherwise there might be the burst.</p>
	CAUTION				
	BURST HAZARD Open the service valves before the operation, otherwise there might be the burst.				

PRECAUTIONS FOR SAFETY



The manufacturer shall not assume any liability for the damage caused by not observing the description of this manual.

DANGER







 Turn off breaker	<p>Before carrying out the installation, maintenance, repair or removal work, be sure to set the circuit breaker for both the indoor and outdoor units to the OFF position. Otherwise, electric shocks may result.</p>
	<p>Before opening the intake grille of the indoor unit or service panel of the outdoor unit, set the circuit breaker to the OFF position. Failure to set the circuit breaker to the OFF position may result in electric shocks through contact with the interior parts. Only a qualified installer (*1) or qualified service person (*1) is allowed to remove the intake grille of the indoor unit or service panel of the outdoor unit and do the work required.</p>
	<p>Before opening the electric box cover set the circuit breaker to the OFF position. Failure to set the circuit breaker to the OFF position may result in injury through contact with the rotation parts. Only a qualified installer (*1) or qualified service person (*1) is allowed to remove the electric box cover and do the work required.</p>
	<p>Before starting to repair the outdoor unit fan or fan guard, be absolutely sure to set the circuit breaker to the OFF position, and place a "Work in progress" sign on the circuit breaker.</p>
	<p>When cleaning the filter or other parts of the indoor unit, set the circuit breaker to OFF without fail, and place a "Work in progress" sign near the circuit breaker before proceeding with the work.</p>
	<p>When you have noticed that some kind of trouble (such as when a check code display has appeared, there is a smell of burning, abnormal sounds are heard, the air conditioner fails to cool or heat or water is leaking) has occurred in the air conditioner, do not touch the air conditioner yourself but set the circuit breaker to the OFF position, and contact a qualified service person. Take steps to ensure that the power will not be turned on (by marking "out of service" near the circuit breaker, for instance) until qualified service person arrives. Continuing to use the air conditioner in the trouble status may cause mechanical problems to escalate or result in electric shocks or other failure.</p>
 Electric shock hazard	<p>When you access inside of the electric cover to repair electric parts, wait for about five minutes after turning off the breaker. Do not start repairing immediately. Otherwise you may get electric shock by touching terminals of high-voltage capacitors. Natural discharge of the capacitor takes about five minutes.</p>
	<p>When checking the electric parts, removing the cover of the electric parts box of Indoor Unit and/or service panel of Outdoor Unit inevitably to determine the failure, use gloves to provide protection for electricians, insulating shoes, clothing to provide protection from electric shock and insulating tools. Be careful not to touch the live part. Electric shock may result. Only "Qualified service person" is allowed to do this work.</p>
 Prohibition	<p>Place a "Work in progress" sign near the circuit breaker while the installation, maintenance, repair or removal work is being carried out. There is a danger of electric shocks if the circuit breaker is set to ON by mistake.</p>
	<p>When checking the electric parts, removing the cover of the electric parts box of Indoor Unit and/or front panel of outdoor unit inevitably to determine the failure, put a sign "Do not enter" around the site before the work. Failure to do this may result in third person getting electric shock.</p>
	<p>Before operating the air conditioner after having completed the work, check that the electrical parts box cover of the indoor unit and service panel of the outdoor unit are closed, and set the circuit breaker to the ON position. You may receive an electric shock if the power is turned on without first conducting these checks.</p>
 Stay on protection	<p>If, in the course of carrying out repairs, it becomes absolutely necessary to check out the electrical parts with the electrical parts box cover of one or more of the indoor units and the service panel of the outdoor unit removed in order to find out exactly where the trouble lies, wear insulated heat-resistant gloves, insulated boots and insulated work overalls, and take care to avoid touching any live parts. You may receive an electric shock if you fail to heed this warning. Only qualified service person (*1) is allowed to do this kind of work.</p>







(*1) Refer to the "Definition of Qualified Installer or Qualified Service Person"

WARNIG



 General	<p>Before starting to repair the air conditioner, read carefully through the Service Manual, and repair the air conditioner by following its instructions.</p>
	<p>Only qualified service person (*1) is allowed to repair the air conditioner. Repair of the air conditioner by unqualified person may give rise to a fire, electric shocks, injury, water leaks and / or other problems.</p>
	<p>Do not use any refrigerant different from the one specified for complement or replacement. Otherwise, abnormally high pressure may be generated in the refrigeration cycle, which may result in a failure or explosion of the product or an injury to your body.</p>
	<p>Only a qualified installer (*1) or qualified service person (*1) is allowed to carry out the electrical work of the air conditioner. Under no circumstances must this work be done by an unqualified individual since failure to carry out the work properly may result in electric shocks and / or electrical leaks.</p>
	<p>When the air conditioner is to be transported, installed, maintained, repaired or removed, wear protective gloves and 'safety' work clothing.</p>
	<p>To connect the electrical wires, repair the electrical parts or undertake other electrical jobs, wear gloves to provide protection for electricians, insulating shoes and clothing to provide protection from electric shocks. Failure to wear this protective gear may result in electric shocks.</p>
	<p>Electrical wiring work shall be conducted according to law and regulation in the community and Installation Manual. Failure to do so may result in electrocution or short circuit.</p>
	<p>Use wiring that meets the specifications in the Installation Manual and the stipulations in the local regulations and laws. Use of wiring which does not meet the specifications may give rise to electric shocks, electrical leakage, smoking and/or a fire.</p>
	<p>Only a qualified installer (*1) or qualified service person (*1) is allowed to undertake work at heights using a stand of 50 cm or more or to remove the intake grille of the indoor unit to undertake work.</p>
	<p>When working at heights, use a ladder which complies with the ISO 14122 standard, and follow the procedure in the ladder's instructions. Also wear a helmet for use in industry as protective gear to undertake the work.</p>
	<p>Before working at heights, put a sign in place so that no-one will approach the work location, before proceeding with the work. Parts and other objects may fall from above, possibly injuring a person below. While carrying out the work, wear a helmet for protection from falling objects.</p>
	<p>When executing address setting, test run, or troubleshooting through the checking window on the electric parts box, put on insulated gloves to provide protection from electric shock. Otherwise you may receive an electric shock.</p>
	<p>Do not touch the aluminum fin of the unit. You may injure yourself if you do so. If the fin must be touched for some reason, first put on protective gloves and safety work clothing, and then proceed.</p>
	<p>Do not climb onto or place objects on top of the outdoor unit. You may fall or the objects may fall off the outdoor unit and result in injury. Use forklift truck to carry in the air conditioner units and use winch or hoist at installation of them.</p>
	<p>When transporting the air conditioner, wear shoes with protective toe caps, protective gloves and other protective clothing.</p>
	<p>When transporting the air conditioner, do not hold the bands around the packing carton. You may injure yourself if the bands should break.</p>
	<p>Be sure that a heavy unit (10 kg or heavier) such as a compressor is carried by four persons.</p>
 Check earth wires.	<p>Before troubleshooting or repair work, check the earth wire is connected to the earth terminals of the main unit, otherwise an electric shock is caused when a leak occurs. If the earth wire is not correctly connected, contact an electric engineer for rework.</p>
	<p>After completing the repair or relocation work, check that the ground wires are connected properly.</p>
	<p>Connect earth wire. (Grounding work) Incomplete grounding causes an electric shock. Do not connect earth wires to gas pipes, water pipes, and lightning rods or ground wires for telephone wires.</p>

(*1) Refer to the "Definition of Qualified Installer or Qualified Service Person"

 Prohibition of modification.	Do not modify the products. Do not also disassemble or modify the parts. It may cause a fire, electric shock or injury.
 Use specified parts.	When any of the electrical parts are to be replaced, ensure that the replacement parts satisfy the specifications given in the Service Manual (or use the parts contained on the parts list in the Service Manual). Use of any parts which do not satisfy the required specifications may give rise to electric shocks, smoking and / or a fire.
 Do not bring a child close to the equipment.	If, in the course of carrying out repairs, it becomes absolutely necessary to check out the electrical parts with the electrical parts box cover of one or more of the indoor units and the service panel of the outdoor unit removed in order to find out exactly where the trouble lies, put a sign in place so that no one will approach the work location before proceeding with the work. Third-party individuals may enter the work site and receive electric shocks if this warning is not heeded.
 Insulating measures	Connect the cut-off lead wires with crimp contact, etc., put the closed end side upward and then apply a watercut method, otherwise a leak or production of fire is caused at the users' side.
 No fire	When performing repairs using a gas burner, replace the refrigerant with nitrogen gas because the oil that coats the pipes may otherwise burn. When repairing the refrigerating cycle, take the following measures. 1) Be attentive to fire around the cycle. When using a gas stove, etc., be sure to put out fire before work; otherwise the oil mixed with refrigerant gas may catch fire. 2) Do not use a welder in the closed room. When using it without ventilation, carbon monoxide poisoning may be caused. 3) Do not bring inflammables close to the refrigerant cycle, otherwise fire of the welder may catch the inflammables.
 Refrigerant	The refrigerant used by this air conditioner is the R32 or R410A. Check the used refrigerant name and use tools and materials of the parts which match with it. For the products which use R32 or R410A refrigerant, the refrigerant name is indicated at a position on the outdoor unit where is easy to see. To prevent miss charging, the route of the service port is changed from one of the former R22. Do not use any refrigerant different from the one specified for complement or replacement. Otherwise, abnormally high pressure may be generated in the refrigeration cycle, which may result in a failure or explosion of the product or an injury to your body. For an air conditioner which uses R32 or R410A, never use other refrigerant than R32 or R410A. For an air conditioner which uses other refrigerant (R22, etc.), never use R32 or R410A. If different types of refrigerant are mixed, abnormal high pressure generates in the refrigerating cycle and an injury due to breakage may be caused. When the air conditioner has been installed or relocated, follow the instructions in the Installation Manual and purge the air completely so that no gases other than the refrigerant will be mixed in the refrigerating cycle. Failure to purge the air completely may cause the air conditioner to malfunction. Do not charge refrigerant additionally. If charging refrigerant additionally when refrigerant gas leaks, the refrigerant composition in the refrigerating cycle changes resulted in change of air conditioner characteristics or refrigerant over the specified standard amount is charged and an abnormal high pressure is applied to the inside of the refrigerating cycle resulted in cause of breakage or injury. Therefore if the refrigerant gas leaks, recover the refrigerant in the air conditioner, execute vacuuming, and then newly recharge the specified amount of liquid refrigerant. In this time, never charge the refrigerant over the specified amount. When recharging the refrigerant in the refrigerating cycle, do not mix the refrigerant or air other than R32 or R410A into the specified refrigerant. If air or others is mixed with the refrigerant, abnormal high pressure generates in the refrigerating cycle resulted in cause of injury due to breakage. After installation work, check the refrigerant gas does not leak. If the refrigerant gas leaks in the room, poisonous gas generates when gas touches to fire such as fan heater, stove or cooking stove though the refrigerant gas itself is innocuous. Never recover the refrigerant into the outdoor unit. When the equipment is moved or repaired, be sure to recover the refrigerant with recovering device. The refrigerant cannot be recovered in the outdoor unit; otherwise a serious accident such as breakage or injury is caused.

 Assembly / Wiring	After repair work, surely assemble the disassembled parts, and connect and lead the removed wires as before. Perform the work so that the cabinet or panel does not catch the inner wires. If incorrect assembly or incorrect wire connection was done, a disaster such as a leak or fire is caused at user's side.
 Insulator check	After the work has finished, be sure to use an insulation tester set (500VMΩ) to check the resistance is 1 MΩ or more between the charge section and the non-charge metal section (Earth position). If the resistance value is low, a disaster such as a leak or electric shock is caused at user's side.
 Ventilation	When the refrigerant gas leaks during work, execute ventilation. If the refrigerant gas touches to a fire, poisonous gas generates. A case of leakage of the refrigerant and the closed room full with gas is dangerous because a shortage of oxygen occurs. Be sure to execute ventilation. If refrigerant gas has leaked during the installation work, ventilate the room immediately. If the leaked refrigerant gas comes in contact with fire, noxious gas may generate. After installation work, check the refrigerant gas does not leak. If the refrigerant gas leaks in the room, poisonous gas generates when gas touches to fire such as fan heater, stove or cooking stove though the refrigerant gas itself is innocuous.
 Compulsion	When the refrigerant gas leaks, find out the leaked position and repair it surely. If the leaked position cannot be found out and the repair work is interrupted, reclaim and tighten the service valve, otherwise the refrigerant gas may leak into the room. The poisonous gas generates when gas touches to fire such as fan heater, stove or cooking stove though the refrigerant gas itself is innocuous. When installing equipment which includes a large amount of charged refrigerant in a sub-room, it is necessary that the concentration does not the limit even if the refrigerant leaks. If the refrigerant leaks and exceeds the limit concentration, an accident of shortage of oxygen is caused. Tighten the flare nut with a torque wrench in the specified manner. Excessive tighten of the flare nut may cause a crack in the flare nut after a long period, which may result in refrigerant leakage. Nitrogen gas must be used for the airtight test. The charge hose must be connected in such a way that it is not slack. For the installation / moving / reinstallation work, follow to the Installation Manual. If an incorrect installation is done, a trouble of the refrigerating cycle, water leak, electric shock or fire is caused.
 Check after repair	Once repair work has been completed, check for refrigerant leaks, and check the insulation resistance and water drainage. Then perform a trial run to check that the air conditioner is running properly. After repair work has finished, check there is no trouble. If check is not executed, a fire, electric shock or injury may be caused. For a check, turn off the power breaker. After repair work (installation of front panel and cabinet) has finished, execute a test run to check there is no generation of smoke or abnormal sound. If check is not executed, a fire or an electric shock is caused. Before test run, install the front panel and cabinet. Be sure to fix the screws back which have been removed for installation or other purposes.
 Do not operate the unit with the valve closed.	Check the following matters before a test run after repairing piping. <ul style="list-style-type: none"> • Connect the pipes surely and there is no leak of refrigerant. • The valve is opened. Running the compressor under condition that the valve closes causes an abnormal high pressure resulted in damage of the parts of the compressor and etc. and moreover if there is leak of refrigerant at connecting section of pipes, the air is sucked and causes further abnormal high pressure resulted in burst or injury.
 Check after reinstallation	Only a qualified installer (*1) or qualified service person (*1) is allowed to relocate the air conditioner. It is dangerous for the air conditioner to be relocated by an unqualified individual since a fire, electric shocks, injury, water leakage, noise and / or vibration may result. Check the following items after reinstallation. <ol style="list-style-type: none"> 1) The earth wire is correctly connected. 2) The power cord is not caught in the product. 3) There is no inclination or unsteadiness and the installation is stable. If check is not executed, a fire, an electric shock or an injury is caused. When carrying out the reclaim work shut down the compressor before disconnecting the refrigerant pipe. Disconnecting the refrigerant pipe with the service valve left open and the compressor still operating will cause air, etc. to be sucked in, raising the pressure inside the refrigeration cycle to an abnormally high level, and possibly resulting in rupture, injury, etc.

(*1) Refer to the "Definition of Qualified Installer or Qualified Service Person"

 Cooling check	<p>When the service panel of the outdoor unit is to be opened in order for the compressor or the area around this part to be repaired immediately after the air conditioner has been shut down, set the circuit breaker to the OFF position, and then wait at least 10 minutes before opening the service panel. If you fail to heed this warning, you will run the risk of burning yourself because the compressor pipes and other parts will be very hot to the touch. In addition, before proceeding with the repair work, wear the kind of insulated heat-resistant gloves designed to protect electricians.</p>
	<p>Take care not to get burned by compressor pipes or other parts when checking the cooling cycle while running the unit as they get heated while running. Be sure to put on gloves providing protection for heat.</p>
 Installation	<p>When the service panel of the outdoor unit is to be opened in order for the fan motor, reactor, inverter or the areas around these parts to be repaired immediately after the air conditioner has been shut down, set the circuit breaker to the OFF position, and then wait at least 10 minutes before opening the service panel. If you fail to heed this warning, you will run the risk of burning yourself because the fan motor, reactor, inverter heat sink and other parts will be very hot to the touch. In addition, before proceeding with the repair work, wear the kind of insulated heat-resistant gloves designed to protect electricians.</p>
	<p>Only a qualified installer or service person is allowed to do installation work. Inappropriate installation may result in water leakage, electric shock or fire.</p>
	<p>Before starting to install the air conditioner, read carefully through the Installation Manual, and follow its instructions to install the air conditioner.</p>
	<p>Be sure to use the company-specified products for the separately purchased parts. Use of non-specified products may result in fire, electric shock, water leakage or other failure. Have the installation performed by a qualified installer.</p>
	<p>Do not supply power from the power terminal block equipped on the outdoor unit to another outdoor unit. Capacity overflow may occur on the terminal block and may result in fire.</p>
	<p>Do not install the air conditioner in a location that may be subject to a risk of exposure to a combustible gas. If a combustible gas leaks and becomes concentrated around the unit, a fire may occur.</p>
	<p>Install the indoor unit at least 2.5 m above the floor level since otherwise the users may injure themselves or receive electric shocks if they poke their fingers or other objects into the indoor unit while the air conditioner is running.</p>
	<p>Install a circuit breaker that meets the specifications in the Installation Manual and the stipulations in the local regulations and laws.</p>
	<p>Install the circuit breaker where it can be easily accessed by the agent.</p>
	<p>If you install the unit in a small room, take appropriate measures to prevent the refrigerant from exceeding the limit concentration even if it leaks. Consult the dealer from whom you purchased the air conditioner when you implement the measures. Accumulation of highly concentrated refrigerant may cause an oxygen deficiency accident.</p>
<p>Do not place any combustion appliance in a place where it is directly exposed to the wind of air conditioner, otherwise it may cause imperfect combustion.</p>	

Explanations given to user

If you have discovered that the fan grille is damaged, do not approach the outdoor unit but set the circuit breaker to the OFF position, and contact a qualified service person to have the repairs done. Do not set the circuit breaker to the ON position until the repairs are completed.

Relocation

- Only a qualified installer (*1) or qualified service person (*1) is allowed to relocate the air conditioner. It is dangerous for the air conditioner to be relocated by an unqualified individual since a fire, electric shocks, injury, water leakage, noise and / or vibration may result.
- When carrying out the reclaim work shut down the compressor before disconnecting the refrigerant pipe. Disconnecting the refrigerant pipe with the service valve left open and the compressor still operating will cause air, etc. to be sucked in, raising the pressure inside the refrigeration cycle to an abnormally high level, and possibly resulting in rupture, injury, etc.

(*1) Refer to the “Definition of Qualified Installer or Qualified Service Person”

Specifications

Model	Sound pressure level (dBA)		Weight (kg)
	Cooling	Heating	
MMK-UP0051DHPL-E(TR)	*	*	12
MMK-UP0071DHPL-E(TR)	*	*	12
MMK-UP0091DHPL-E(TR)	*	*	12
MMK-UP0121DHPL-E(TR)	*	*	12
MMK-UP0151DHPL-E(TR)	*	*	12
MMK-UP0181DHPL-E(TR)	*	*	12

* Under 70 dBA

- **New Refrigerant (R32 or R410A)**

This air conditioner adopts a new HFC type refrigerant (R32 or R410A) which does not deplete the ozone layer.

1. Safety Caution Concerned to New Refrigerant

The pressure of R32 or R410A is high 1.6 times of that of the former refrigerant (R22).

Accompanied with change of refrigerant, the refrigerating oil has been also changed.

Therefore, be sure that water, dust, the former refrigerant or the former refrigerating oil is not mixed into the refrigerating cycle of the air conditioner with new refrigerant during installation work or service work.

If an incorrect work or incorrect service is performed, there is a possibility to cause a serious accident.

Use the tools and materials exclusive to R32 or R410A to purpose a safe work.

2. Cautions on Installation/Service

(1) Do not mix the other refrigerant or refrigerating oil.

For the tools exclusive to R32 or R410A, shapes of all the joints including the service port differ from those of the former refrigerant in order to prevent mixture of them.

(2) As the use pressure of the new refrigerant is high, use material thickness of the pipe and tools which are specified for R32 or R410A.

(3) In the installation time, use clean pipe materials and work with great attention so that water and others do not mix in because pipes are affected by impurities such as water, oxide scales, oil, etc. Use the clean pipes.

Be sure to brazing with flowing nitrogen gas. (Never use gas other than nitrogen gas.)

(4) For the earth protection, use a vacuum pump for air purge.

(5) R32 or R410A refrigerant is azeotropic mixture type refrigerant.

Therefore use liquid type to charge the refrigerant. (If using gas for charging, composition of the refrigerant changes and then characteristics of the air conditioner change.)

3. Pipe Materials

For the refrigerant pipes, copper pipe and joints are mainly used.

It is necessary to select the most appropriate pipes to conform to the standard.

Use clean material in which impurities adhere inside of pipe or joint to a minimum.

(1) Copper pipe

<Piping>

The pipe thickness, flare finishing size, flare nut and others differ according to a refrigerant type.

When using a long copper pipe for R32 or R410A, it is recommended to select "Copper or copper-base pipe without seam" and one with bonded oil amount 40mg/10m or less.

Also do not use crushed, deformed, discolored (especially inside) pipes. (Impurities cause clogging of expansion valves and capillary tubes.)

<Flare nut>

Use the flare nuts which are attached to the air conditioner unit.

(2) Joint

The flare joint and socket joint are used for joints of the copper pipe.

The joints are rarely used for installation of the air conditioner.

However clear impurities when using them.

4. Tools

(1) Required Tools for R32 or R410A

Mixing of different types of oil may cause a trouble such as generation of sludge, clogging of capillary, etc. Accordingly, the tools to be used are classified into the following three types.

- 1) Tools exclusive for R32 or R410A (Those which cannot be used for conventional refrigerant (R22))
- 2) Tools exclusive for R32 or R410A, but can be also used for conventional refrigerant (R22)
- 3) Tools commonly used for R32 or R410A and for conventional refrigerant (R22)

The table below shows the tools exclusive for R32 or R410A and their interchangeability.

Tools exclusive for R32 or R410A (The following tools for R410A are required.)

Tools whose specifications are changed for R32 or R410A and their interchangeability

No.	Used tool	Usage	R32 or R410A air conditioner installation		Conventional air conditioner installation
			Existence of new equipment for R32 or 410A	Whether conventional equipment can be used	Whether new equipment can be used with conventional refrigerant
①	Flare tool	Pipe flaring	Yes	*(Note 1)	Yes
②	Copper pipe gauge for adjusting projection margin	Flaring by conventional flare tool	Yes	*(Note 1)	*(Note 1)
③	Torque wrench	Connection of flare nut	Yes	No	No
④	Gauge manifold	Evacuating, refrigerant charge, run check, etc.	Yes	No	No
⑤	Charge hose				
⑥	Vacuum pump adapter	Vacuum evacuating	Yes	No	Yes
⑦	Electronic balance for refrigerant charging	Refrigerant charge	Yes	Yes	Yes
⑧	Refrigerant cylinder	Refrigerant charge	Yes	No	No
⑨	Leakage detector	Gas leakage check	Yes	No	Yes
⑨	Charging cylinder	Refrigerant charge	(Note 2)	No	No

(Note 1) When flaring is carried out for R32 or R410A using the conventional flare tools, adjustment of projection margin is necessary. For this adjustment, a copper pipe gauge, etc. are necessary.

(Note 2) Charging cylinder for R32 or R410A is being currently developed.

General tools (Conventional tools can be used.)

In addition to the above exclusive tools, the following equipments which serve also for R22 are necessary as the general tools.

- 1) Vacuum pump
Use vacuum pump by attaching vacuum pump adapter.
- 2) Torque wrench
- 3) Pipe cutter
- 4) Reamer
- 5) Pipe bender
- 6) Level vial
- 7) Screwdriver (+, -)
- 8) Spanner or Monkey wrench
- 9) Hole core drill
- 10) Hexagon wrench (Opposite side 4mm)
- 11) Tape measure
- 12) Metal saw

Also prepare the following equipments for other installation method and run check.

- 1) Clamp meter
- 2) Thermometer
- 3) Insulation resistance tester
- 4) Electroscopes

1. SPECIFICATIONS

VRF FCU High wall (PMV less model)

Model name		MMK-UP0051DHPL-E(TR)	MMK-UP0071DHPL-E(TR)	MMK-UP0091DHPL-E(TR)	MMK-UP0121DHPL-E(TR)	
Cooling Capacity (kW)		1.70	2.20	2.80	3.60	
Heating Capacity (kW)		1.90	2.50	3.20	4.00	
Electrical characteristics	Power supply	220-240V~50Hz. & 208-230V~60Hz				
	Running current (A)	0.17	0.18	0.19	0.20	
	Power consumption (Kw)	0.015	0.018	0.019	0.021	
	Starting current (A)	0.22	0.23	0.24	0.25	
Appearance	Main unit	Gran White				
	Ceiling panel	Model name	-			
		Panel Color	-			
Outer dimension	Main unit	Height (mm)	300	300	300	300
		Width (mm)	987	987	987	987
		Depth (mm)	210	210	210	210
	Ceiling panel	Height (mm)	-	-	-	-
		Width (mm)	-	-	-	-
		Depth (mm)	-	-	-	-
Total weight	Main unit (kg)	12	12	12	12	
	Ceiling panel (kg)	-	-	-	-	
Heat exchanger		Finned tube				
Fan unit	Fan	Cross flow fan				
	Standard air flow	HH/H+/H/L+/L (m3/hr.)	455/410/370/325/300	480/430/385/330/300	510/450/395/330/300	540/475/410/325/300
	Motor (W)	42	42	42	42	
Air filter		Standard filter attached (Long life filter)				
Controller		WH-UB01UE	WH-UB01UE	WH-UB01UE	WH-UB01UE	
Sound pressure level	HH/H+/H/L+/L (dBA)	33/31/29/27/25	35/33/30/28/25	36/34/31/28/25	37/35/32/28/25	
Sound power level	High (dBA)	48	50	51	52	
Connecting pipe	Gas side (mm)	9.52	9.52	9.52	9.52	
	Liquid (mm)	6.35	6.35	6.35	6.35	
	Drain tube size (mm)	16.3				

Model name		MMK-UP0151DHPL-E(TR)	MMK-UP0181DHPL-E(TR)
Cooling Capacity (kW)		4.50	5.60
Heating Capacity (kW)		5.00	6.30
Electrical characteristics	Power supply		220-240V~50Hz. & 208-230V~60Hz
	Running current (A)	0.22	0.28
	Power consumption (Kw)	0.025	0.032
	Starting current (A)	0.27	0.33
Appearance	Main unit		Gran White
	Ceiling panel	Model name	-
		Panel Color	-
Outer dimension	Main unit	Height (mm)	300
		Width (mm)	987
		Depth (mm)	210
	Ceiling panel	Height (mm)	-
		Width (mm)	-
		Depth (mm)	-
Total weight	Main unit (kg)	12	12
	Ceiling panel (kg)	-	-
Heat exchanger		Finned tube	
Fan unit	Fan		Cross flow fan
	Standard air flow	HH/H+/H/L+/L (m3/hr.)	580/530/480/420/380
	Motor (W)	42	42
Air filter		Standard filter attached (Long life filter)	
Controller		WH-UB01UE	WH-UB01UE
Sound pressure level	HH/H+/H/L+/L (dBA)	40/38/35/33/30	45/42/39/36/32
Sound power level	High (dBA)	55	60
Connecting pipe	Gas side (mm)	12.70	12.70
	Liquid (mm)	6.35	6.35
	Drain port (mm)	16.3	

2. CONSTRUCTION VIEWS (EXTERNAL VIEWS)

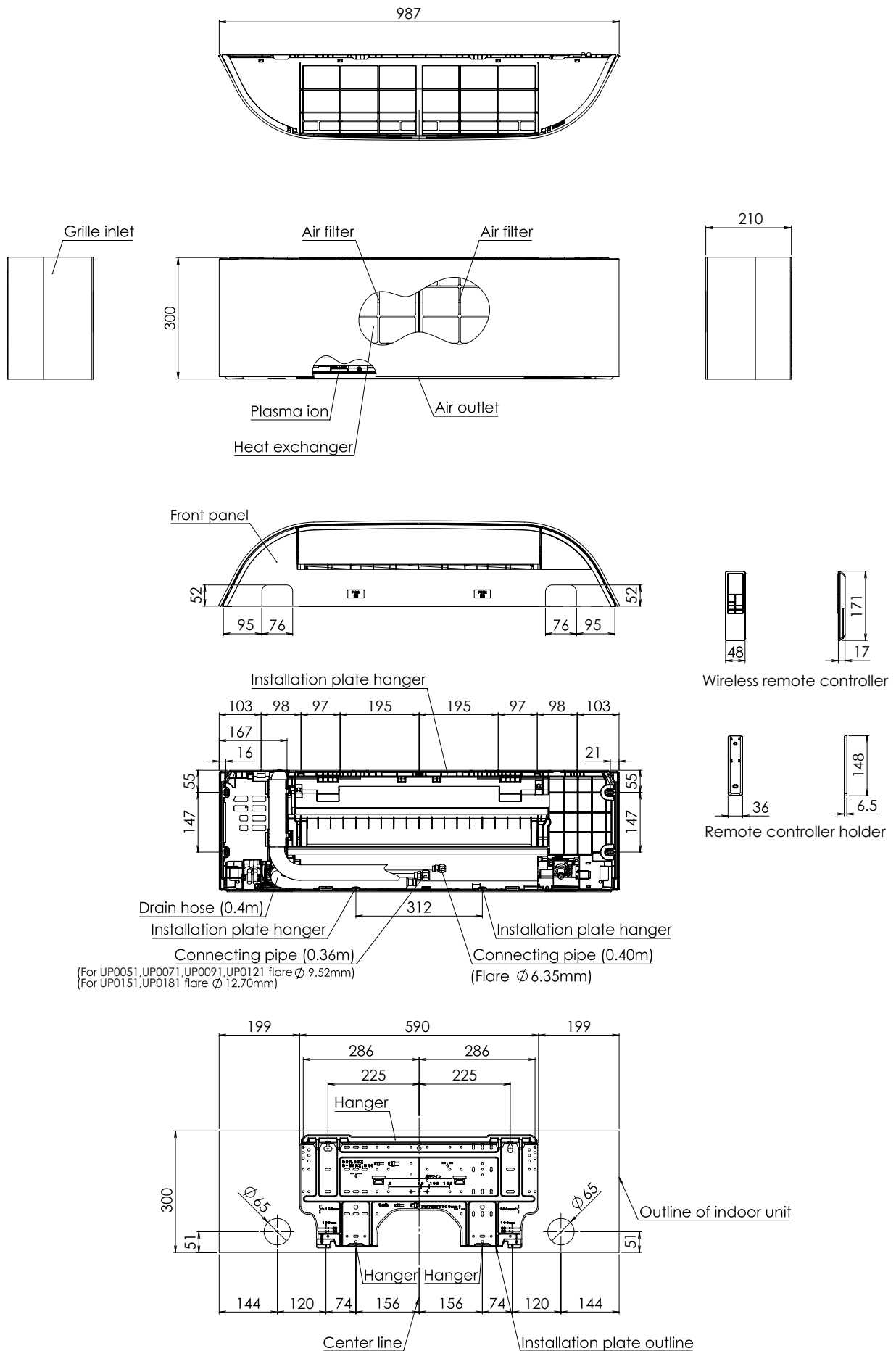

3. WIRING DIAGRAM

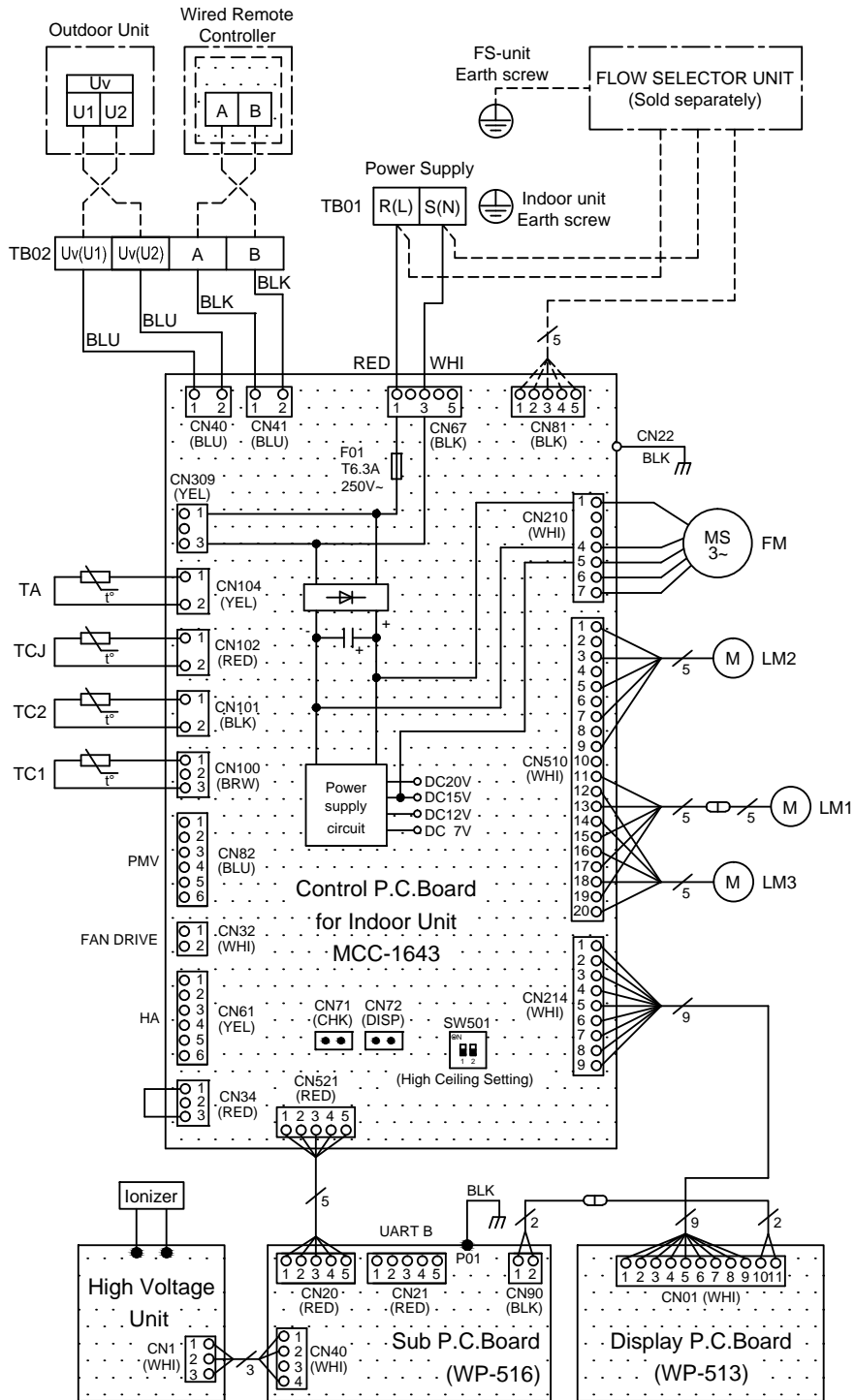

Symbol	Parts Name
CN***	Connector
F01	Fuse
FM	Fan Motor
LM**	Louver Motor
TA	Indoor temp sensor
TB01, 02	Terminal Block
TC1, TC2, TCJ	Temp sensor

COLOR INDICATION	
RED:	RED
WHI:	WHITE
YEL:	YELLOW
BLU:	BLUE
BLK:	BLACK
BRW:	BROWN

4. PARTS RATING

4-1. Parts Rating

No.	Parts Name	Type	Specifications
1	Fan motor (for indoor)	ICF-340-30-6A	Output (Rated) 42W, 280V DC
2	Louver motor	MSBPC20F04, 24BYJ48-ST	4 phase, DC 12V
3	Thermo. Sensor (TA sensor)	418mm	10kΩ at 25°C
4	Heat exchanger sensor (TC2 sensor)	Ø6, 450mm	10kΩ at 25°C
5	Heat exchanger sensor (TCJ sensor)	Ø6, 380mm	10kΩ at 25°C
6	Heat exchanger sensor (TC1 sensor)	Ø4, 500mm	10kΩ at 25°C

4-2. Name of Each Part

■ Name of Each Part

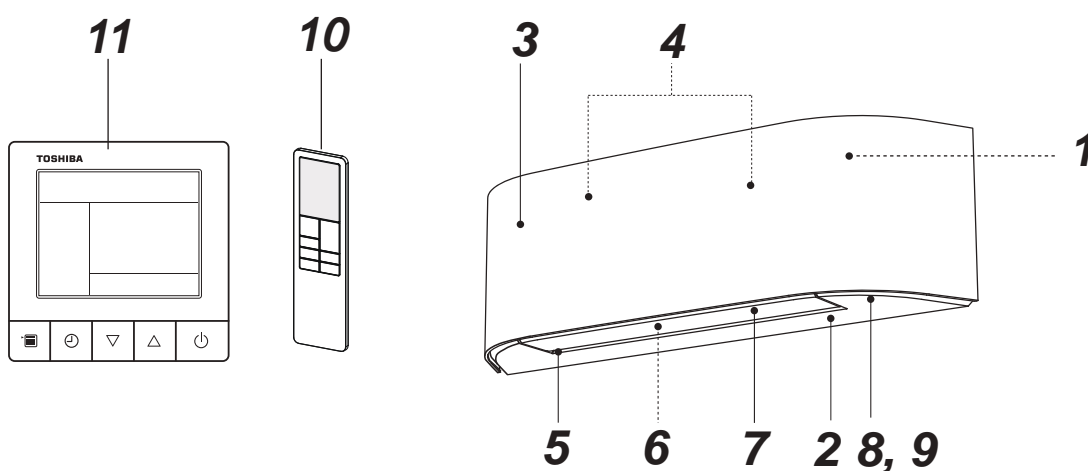

- 1** Room temperature sensor
- 2** Front panel
- 3** Air inlet grille
- 4** Air filter
- 5** Air outlet

- 6** Horizontal airflow louver
- 7** Vertical airflow louver
- 8** Display panel
- 9** Infrared signal receiver
- 10** Remote controller (wireless)
- 11** Remote controller (wired, sold separately)

5. REFRIGERANT CYCLE DIAGRAM

Indoor unit

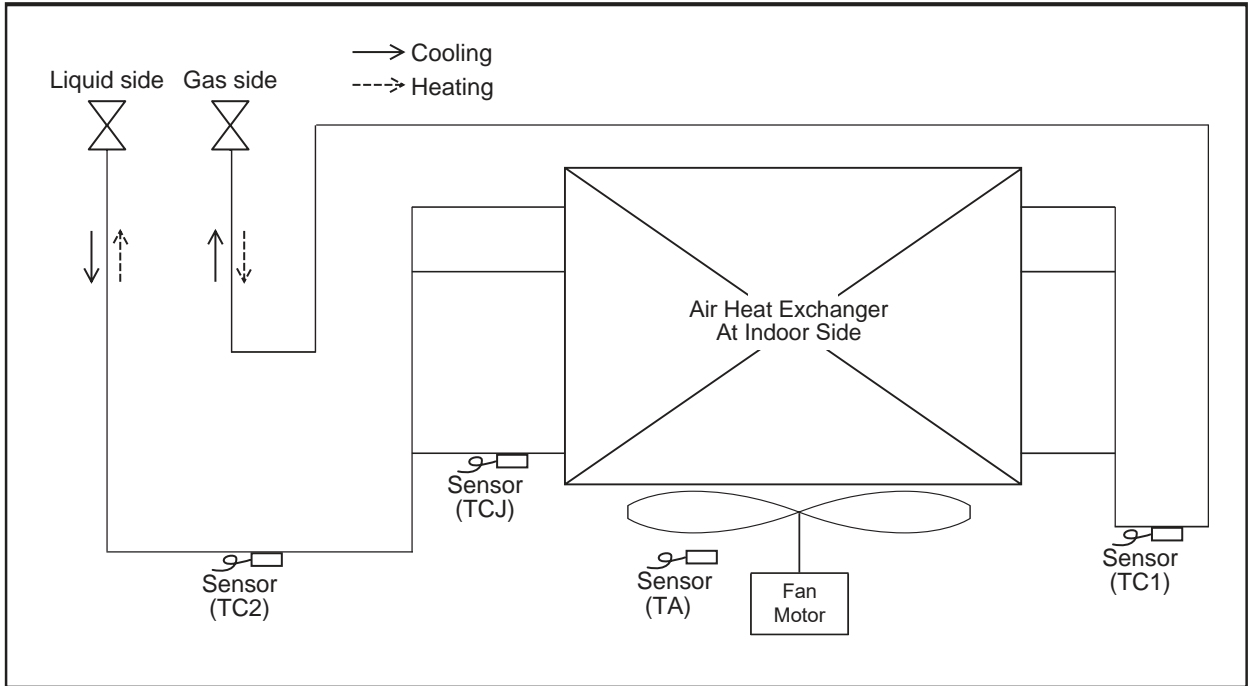

Explanation of functional parts in indoor unit

Functional part name		Functional outline
Temp. Sensor	TA	(Connector CN104 (2P): Yellow) 1) Detects indoor suction temperature
	TC1	(Connector CN100 (3P): Brown) 1) Controls PMV superheat in cooling operation
	TC2	(Connector CN101 (2P): Black) 1) Controls PMV subcool in heating operation
	TCJ	(Connector CN102 (2P): Red) 1) Controls PMV superheat in cooling operation

6. CONTROL OUTLINE

Indoor Unit Control Specifications

No.	Item	Outline of specifications	Remarks																					
1	Power supply is reset.	<p>(1) Distinction of outdoor unit When the power supply is reset, the outdoor units are distinguished, and control is exchanged according to the distinctive results.</p> <p>(2) Check code clear When the power supply is reset, the check code is also reset once. If an abnormal status which the check code appears after Start/Stop button of the remote controller has been pushed continues, the check code is displayed again on the remote controller.</p>	<ul style="list-style-type: none"> Judgment of outdoor unit Exchange of cooling-only unit Exchange of standard model with the flex model 																					
2	Operation select	<p>(1) Based upon the operation select command from the remote controller or central controller, the operation mode is selected.</p> <table border="1"> <thead> <tr> <th>Remote controller command</th> <th>Control outline</th> </tr> </thead> <tbody> <tr> <td>STOP</td> <td>Stops air conditioner.</td> </tr> <tr> <td>FAN</td> <td>Fan operation</td> </tr> <tr> <td>COOL</td> <td>Cooling operation</td> </tr> <tr> <td>DRY</td> <td>Dry operation</td> </tr> <tr> <td>HEAT</td> <td>Heating operation</td> </tr> <tr> <td>AUTO</td> <td>Cooling or HEAT operation mode is automatically selected by Ta and Ts and the unit starts operation.</td> </tr> </tbody> </table> <p>(2) Operation command permission mode Neither AUTO mode of the standard model nor HEAT mode of Cooling-only model can be selected. When a wireless remote control is used, the mode is notified by the receiving sound Pi, Pi (Twice) and alternative flashing of “☹” and “☹”. To release the alternative flashing, change the mode on the wireless remote controller.</p>	Remote controller command	Control outline	STOP	Stops air conditioner.	FAN	Fan operation	COOL	Cooling operation	DRY	Dry operation	HEAT	Heating operation	AUTO	Cooling or HEAT operation mode is automatically selected by Ta and Ts and the unit starts operation.								
Remote controller command	Control outline																							
STOP	Stops air conditioner.																							
FAN	Fan operation																							
COOL	Cooling operation																							
DRY	Dry operation																							
HEAT	Heating operation																							
AUTO	Cooling or HEAT operation mode is automatically selected by Ta and Ts and the unit starts operation.																							
3	Room temp. control	<p>(1) Adjustment range Set temperature on remote controller (°C)</p> <table border="1"> <thead> <tr> <th></th> <th>In cooling/drying</th> <th>In heating</th> </tr> </thead> <tbody> <tr> <td>Wired type</td> <td>18 to 29°C</td> <td>18 to 29°C</td> </tr> <tr> <td>Wireless type</td> <td>17 to 30°C</td> <td>17 to 30°C</td> </tr> </tbody> </table> <p>(2) From the item code 06, the setup temperature in heating operation can be corrected.</p> <table border="1"> <thead> <tr> <th>Setup data</th> <th>0</th> <th>2</th> <th>4</th> <th>6</th> </tr> </thead> <tbody> <tr> <td>Setup temp. correction</td> <td>+0°C</td> <td>+2°C</td> <td>+4°C</td> <td>+6°C</td> </tr> </tbody> </table> <p>Setup at shipment</p> <table border="1"> <tbody> <tr> <td>Setup data</td> <td>2</td> </tr> </tbody> </table>		In cooling/drying	In heating	Wired type	18 to 29°C	18 to 29°C	Wireless type	17 to 30°C	17 to 30°C	Setup data	0	2	4	6	Setup temp. correction	+0°C	+2°C	+4°C	+6°C	Setup data	2	Heating suction temperature shift
	In cooling/drying	In heating																						
Wired type	18 to 29°C	18 to 29°C																						
Wireless type	17 to 30°C	17 to 30°C																						
Setup data	0	2	4	6																				
Setup temp. correction	+0°C	+2°C	+4°C	+6°C																				
Setup data	2																							
4	Automatic capacity control	(1) Based upon difference between Ta and Ts, the operation frequency of the outdoor unit varies.	Ta: Room temperature Ts: Setup temperature																					
5	Air volume control	<p>(1) By the command from the remote controller, “HIGH (HH)”, “MED (H)”, or “LOW (L)” “AUTO” operation is executed. For the wireless remote controller type, “HH”, “H+”, “H”, “L+”, “L”, or “AUTO” operation is executed.</p> <p>(2) While air speed is in AUTO mode, the air speed is changed according to the difference between Ta and Ts.</p>	HH > H+ > H > L+ > L > LL																					

No.	Item	Outline of specifications	Remarks
6	Fan speed selection		Standard or Type 1, 3, or 6 can be selected with Code No. [5d] or switching of SW501 on P.C. board.





VRF FCU High wall

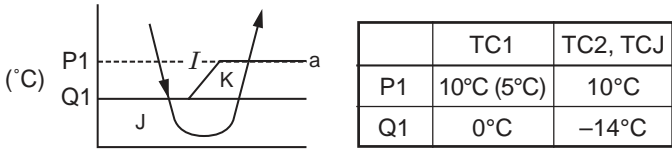
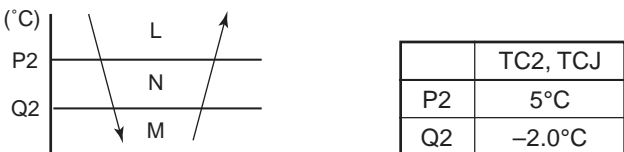

Setting Data	DN	DN[5D] = 00		DN[5D] = 01		DN[5D] = 02		DN[5D] = 03		DN[5D] = 04		DN[5D] = 05		DN[5D] = 06	
		Cooling,Dry	Heating	Cooling,Dry	Heating	Cooling,Dry	Heating	Cooling,Dry	Heating	Cooling,Dry	Heating	Cooling,Dry	Heating	Cooling,Dry	Heating
		Fan only		Fan only		Fan only		Fan only		Fan only		Fan only		Fan only	
DC fan tap F1	4F							HH	HH					HH	HH
DC fan tap F2	50			HH	HH										
DC fan tap F3	51		HH		H+	HH	HH	H+, H	H+, H					H+,H,L+L	H+,H,L+L
DC fan tap F4	52	HH		H+		H+	H+					HH	HH		
DC fan tap F5	53		H+		H	H+	H+								
DC fan tap F6	54	H+		H		H	H	L+	L+						
DC fan tap F7	55		H			H	H	L	L		HH				
DC fan tap F8	56	H			L+		L+			HH	H+,H			H+,H	
DC fan tap F9	57		L+	L+	L	L+	L			H+, H		H+, H			
DC fan tap FA	58	L+		L		L					L+		L+		
DC fan tap FB	59		L							L+	L	L+	L		
DC fan tap FC	5A	L								L		L			
DC fan tap FD	5B	LL	LL	LL	LL	LL	LL	LL	LL	LL	LL	LL	LL	LL	LL



3) In heating operation, the mode changes to [LL] if thermostat is turned off.

7	Prevention of cold air discharge	<p>(1) In heating operation, the upper limit of the fan tap is set by one with higher temperature of TC2 sensor and TCJ sensor.</p> <ul style="list-style-type: none"> When B zone has continued for 6 minutes, the operation shifts to C zone. In defrost time, the control point is set to +6°C. <p>A zone: OFF B zone: Over 30°C, below 32°C, UL C zone: Over 32°C, below 24°C, L D zone: Over 24°C, below 36°C, H E zone: HH</p>	<ul style="list-style-type: none"> In D and E zones, priority is given to remote controller air speed setup. In A and B zones, “⊗” is displayed.
---	----------------------------------	--	--



No.	Item	Outline of specifications	Remarks															
8	Freeze prevention control (Low temp. release)	<p>(1) In cooling operation, the air conditioner operates as described below based upon temp. detected by TC1, TC2 and TCJ sensors.</p> <p>To prevent the heat exchanger from freezing, the operation stops.</p> <ul style="list-style-type: none"> • When “J” zone is detected for 5 minutes, the forced thermo is OFF. • In “K” zone, the timer count is interrupted, and held. • When “I” zone is detected, the timer is cleared and the operation returns to the normal operation. • When the forced thermo-OFF became S0 with continuation of “J” zone, operation of the the indoor fan in LOW (L) mode until it reaches the “I” zone. <p>It is reset when the following conditions are satisfied.</p> <p>Reset conditions</p> <ol style="list-style-type: none"> 1) $TC1 \geq 12^{\circ}\text{C}$ and $TC2 \geq 12^{\circ}\text{C}$ and $TCJ \geq 12^{\circ}\text{C}$ 2) 20 minutes passed after stop. <div style="display: flex; align-items: center;">  <table border="1" style="margin-left: 20px;"> <thead> <tr> <th></th> <th>TC1</th> <th>TC2, TCJ</th> </tr> </thead> <tbody> <tr> <td>P1</td> <td>10°C (5°C)</td> <td>10°C</td> </tr> <tr> <td>Q1</td> <td>0°C</td> <td>-14°C</td> </tr> </tbody> </table> </div> <p>(2) In cooling operation, the air conditioner operates as described below based upon temp. detected by TC2 and TCJ sensors.</p> <ul style="list-style-type: none"> • When “M” zone is detected for 45 minutes, the forced thermo is OFF. • In “N” zone, the timer count is interrupted and held. • When shifting to “M” zone again, the timer count restarts and continues. • If “L” zone is detected, the timer is cleared and the operation returns to normal operation. <p>Reset conditions</p> <ol style="list-style-type: none"> 1) $TC1 \geq 12^{\circ}\text{C}$ and $TC2 \geq 12^{\circ}\text{C}$ and $TCJ \geq 12^{\circ}\text{C}$ 2) 20 minutes passed after stop. <div style="display: flex; align-items: center;">  <table border="1" style="margin-left: 20px;"> <thead> <tr> <th></th> <th>TC2, TCJ</th> </tr> </thead> <tbody> <tr> <td>P2</td> <td>5°C</td> </tr> <tr> <td>Q2</td> <td>-2.0°C</td> </tr> </tbody> </table> </div>		TC1	TC2, TCJ	P1	10°C (5°C)	10°C	Q1	0°C	-14°C		TC2, TCJ	P2	5°C	Q2	-2.0°C	
	TC1	TC2, TCJ																
P1	10°C (5°C)	10°C																
Q1	0°C	-14°C																
	TC2, TCJ																	
P2	5°C																	
Q2	-2.0°C																	

No.	Item	Outline of specifications	Remarks
9	Cooling oil (refrigerant) recovery control	<p>While the outdoor unit is recovering cooling oil (refrigerant), the indoor units perform the following control tasks: [common for operational (cooling thermo ON/thermo OFF/FAN), as well as nonoperational indoor units]</p> <p>(1) Open the indoor PMV to a certain degree. (2) Engage in recovery control for a specified period of time and return to normal cooling operation at the end of this period upon terminating the control.</p>	<ul style="list-style-type: none"> • Recovery operation normally takes place roughly every 2 hours. • The opening position of the indoor PMV depending on the type and capacity of the indoor unit.
10	Heating refrigerant (oil) recovery control	<p>While the outdoor unit is recovering heating refrigerant (oil), the indoor units perform the following control tasks:</p> <p>(1) Open the indoor PMV to a certain degree. (2) Control the indoor fan according to the operation mode. [Indoor units operating in heating thermo ON/OFF state] Let the indoor fan continue operating, but turn it off if the temperature of the indoor heat exchanger drops. [Indoor units operating in FAN mode] Turn off the indoor fan and display "HEATING STANDBY"  " on the remote controller. [Non-operational indoor units] Keep the indoor fan turned off. (3) Terminate the recovery operation depending on the TC2 temperature reading. The timing of termination is determined by each indoor unit.</p>	<ul style="list-style-type: none"> • Recovery operation normally takes place roughly every hour. • The opening position of the indoor PMV depending on the type and capacity of the indoor unit.
11	Short intermittent operation compensation control	<p>(1) For 5 minutes after the operation has started, the operation is continued even if entering thermostat-OFF condition. (2) However, Cooling/Heating exchange and the system protective control precede and thermostat is OFF.</p>	
12	Elimination of remaining heat	<p>(1) When the air conditioner stops in the "HEAT" mode, drive the indoor fan with "LOW" mode for approx. 30 seconds.</p>	
13	Flap control (Horizontal)	<p>(1) Flap position setup (Wired type)</p> <ul style="list-style-type: none"> • The flap position can be set up in the following operation range. <p style="text-align: center;">In cooling/dry operation In heating/fan operation</p> <div style="display: flex; justify-content: space-around; align-items: center;">   </div> <ul style="list-style-type: none"> • In group operation, the flap positions can be set up collectively or individually. <p>(2) Swing setup</p> <ul style="list-style-type: none"> • The swinging position can be moved in the following operation range. <p style="text-align: center;">All modes</p>  <ul style="list-style-type: none"> • In group operation, the swinging positions can be set up collectively or individually. <p>(3) Fix set up (Wireless type) Keep pressing or pressing briefly the FIX button to move the flap in the desired direction. Operating angle of flap will be different during cooling, dry and heating operation.</p> <p>(4) When the unit stops, the flap automatically closes. (5) While the heating operation is ready, the flap automatically moves upward.</p>	

No.	Item	Outline of specifications	Remarks
14	Flap control (Vertical)	<p>(1) Flap position setup (Wired type)</p> <ul style="list-style-type: none"> The flap position can be set up in the following operation range. <p style="text-align: center;">In Cooling / Dry / Heating / Fan operation</p>  <ul style="list-style-type: none"> In group operation, the flap positions can be set up collectively or individually. <p>(2) Swing setup</p> <ul style="list-style-type: none"> The swinging position can be moved in the following operation range.  <ul style="list-style-type: none"> In group operation, the swinging positions can be set up collectively or individually. <p>(3) Fix set up (Wireless type) Keep pressing or pressing briefly the FIX button to move the flap in the desired direction.</p> <p>(4) When the unit stops, the flap automatically to right position.</p> <p>(5) While the preheating operation the flap automatically more center.</p>	
15	Filter sign display (None in wireless type)	<p>(1) The operation time of the indoor fan is integrated and stored in memory, and the filter exchange signal is sent to the remote controller to display on the remote controller LCD after the specified time. (150H)</p> <p>(2) When the filter reset signal is received form the remote controller, time of the integrated timer is cleared. In this time, if the specified time has passed, the measured time is reset and LCD display disappears.</p>	

No.	Item	Outline of specifications	Remarks																																																		
16	Operation standby Heating standby	<p><Operation standby> .. Displayed on wired remote controller</p> <p>(1) When any of the DN codes listed below is displayed</p> <ul style="list-style-type: none"> • “P05” - Detection of an open phase in the power supply wiring • “P10” - Detection of indoor flooding in at least one indoor unit • “L30” - Detection of an interlock alarm in at least one indoor unit <p>(2) Forced thermo OFF</p> <ul style="list-style-type: none"> • “COOL/DRY” operation is unavailable because at least one indoor unit is operating in “HEAT” mode. • “HEAT” operation is unavailable because at least one indoor unit is operating in “COOL/DRY” mode under priority cooling setting (bit 1 of SW11 on outdoor I/F P.C. board ON). <p>(3) All indoor units not able to engage in any of the above operations stand by in thermo OFF state.</p> <p>(4) The indoor fan has been turned off because the system is engaged in a heat refrigerant (oil) recovery operation.</p> <p><Heating standby> Displayed on wired remote controller</p> <p>(1) Normal thermo OFF</p> <ul style="list-style-type: none"> • During heating, the indoor unit goes thermo OFF as the heating temperature setting is reached. <p>(2) During heating, the fan rotates at a breeze speed (UL or lower) or remains stationary to prevent cold air from being discharged (including defrosting operation).</p> <p>(3) Forced thermo OFF</p> <ul style="list-style-type: none"> • “HEAT” operation is unavailable because at least one indoor unit is operating in “COOL/DRY” mode under priority cooling setting (bit 1 of SW11 on outdoor I/F P.C. board ON). 	<ul style="list-style-type: none"> • “OPERATION STANDBY  ” displayed No display provided on wireless remote controller • “HEATING STANDBY  ” displayed 																																																		
17	Selection of central control mode	<p>(1) The range of operations that can be performed via an indoor unit remote controller can be determined through the setting of the central controller.</p> <p>(2) Setting details TCC-Link central control</p> <table border="1" data-bbox="215 1377 1093 1736"> <thead> <tr> <th rowspan="2">Operation via TCC-Link central control</th> <th colspan="6">Operation via RBC-AMT32E</th> <th rowspan="2">RBC-AMT32E display</th> </tr> <tr> <th>Start/stop selection</th> <th>Operation mode selection</th> <th>Timer setting</th> <th>Temperature setting</th> <th>Fan speed setting</th> <th>Air flow direction setting</th> </tr> </thead> <tbody> <tr> <td>Individual</td> <td>○</td> <td>○</td> <td>○</td> <td>○</td> <td>○</td> <td>○</td> <td rowspan="5">“CENTRAL CONTROL IN PROGRESS”</td> </tr> <tr> <td>Central 1</td> <td>✕</td> <td>○</td> <td>✕</td> <td>○</td> <td>○</td> <td>○</td> </tr> <tr> <td>Central 2</td> <td>✕</td> <td>✕</td> <td>✕</td> <td>✕</td> <td>○</td> <td>○</td> </tr> <tr> <td>Central 3</td> <td>○</td> <td>✕</td> <td>○</td> <td>✕</td> <td>○</td> <td>○</td> </tr> <tr> <td>Central 4</td> <td>○</td> <td>✕</td> <td>○</td> <td>○</td> <td>○</td> <td>○</td> </tr> </tbody> </table>	Operation via TCC-Link central control	Operation via RBC-AMT32E						RBC-AMT32E display	Start/stop selection	Operation mode selection	Timer setting	Temperature setting	Fan speed setting	Air flow direction setting	Individual	○	○	○	○	○	○	“CENTRAL CONTROL IN PROGRESS”	Central 1	✕	○	✕	○	○	○	Central 2	✕	✕	✕	✕	○	○	Central 3	○	✕	○	✕	○	○	Central 4	○	✕	○	○	○	○	<ul style="list-style-type: none"> • In the case of a wired remote controller, “CENTRAL CONTROL IN PROGRESS  ” is displayed (lit up) while in central control mode. • The display blinks when a control function inaccessible to a remote controller is chosen. • A wireless remote controller has the same set of control functions, although there is no display. When a control operation is performed via a wireless remote controller while in central control mode, a peep sound alert (5 times) is provided.
Operation via TCC-Link central control	Operation via RBC-AMT32E						RBC-AMT32E display																																														
	Start/stop selection	Operation mode selection	Timer setting	Temperature setting	Fan speed setting	Air flow direction setting																																															
Individual	○	○	○	○	○	○	“CENTRAL CONTROL IN PROGRESS”																																														
Central 1	✕	○	✕	○	○	○																																															
Central 2	✕	✕	✕	✕	○	○																																															
Central 3	○	✕	○	✕	○	○																																															
Central 4	○	✕	○	○	○	○																																															

No.	Item	Outline of specifications	Remarks
18	Hi POWER operation (Wireless remote control specific operations)	<p>When you press the Hi POWER button during cooling, heating or A operation, the air conditioner will start the following operation.</p> <ul style="list-style-type: none"> Cooling operation Performs the cooling operation at 1°C lower than the setting temperature. Only when the fan speed before the Hi POWER operation is not high, the fan speed will be increased. Heating operation Performs the heating operation at 2°C higher than the setting temperature. Only when the fan speed before the Hi POWER operation is not high, the fan speed will be increased. 	
19	ECO timer operation (Wireless remote control specific operations)	<p>When you press the ECO button during cooling, heating or A operation, the air conditioner will start the following operation. The fan speed display will indicate AUTO and low speed will be used.</p> <ul style="list-style-type: none"> Cooling operation In the operation suppression zone, where capacity is kept to the minimum, overcooling is prevented by raising the temperature setting by 1°C after 1 hour and by 2°C after 2 hours of operation. The room temperature is thus regulated between the operation suppression zone and the set temperature. Heating operation In the operation suppression zone, where capacity is kept to the minimum, overheating is prevented by lowering the temperature setting by 1°C after 1 hour and by 2°C after 2 hours of operation. The room temperature is thus regulated between the set temperature and the operation suppression zone. <div data-bbox="550 1310 1013 1814" style="text-align: center;"> </div>	

No.	Item	Outline of specifications	Remarks
20	DC motor	<p>(1) When the fan stator, positioning is performed for the starter and the rotor. (Vibrate slightly)</p> <p>(2) DC motor operates according to the command from the indoor controller.</p> <p>(Note) If the fan lock was detected, the operation of the indoor unit stops and the error is displayed.</p>	Check code [P12]
21	Save operation	<p>(1) The save operation starts when  button on the remotecontroller is turned on.</p> <p>(2) While the save operation is performed,  segment goes on the screen of the wired remote controller.</p> <p>(3) The request capacity ratio is restricted to approx. 75% during save operation.</p> <p>(4) If the save operation was validated, the contents are held during the operation stop, the operation mode change and the resetting of power supply. Therefore the operation at the next time also will be activated with "Save operation is valid"</p>	RBC-AMT32E

7. CONFIGURATION OF CONTROL CIRCUIT

7-1. IndoorController block diagram (MCC-1643)

7-1-1. Connection of wired remote controller

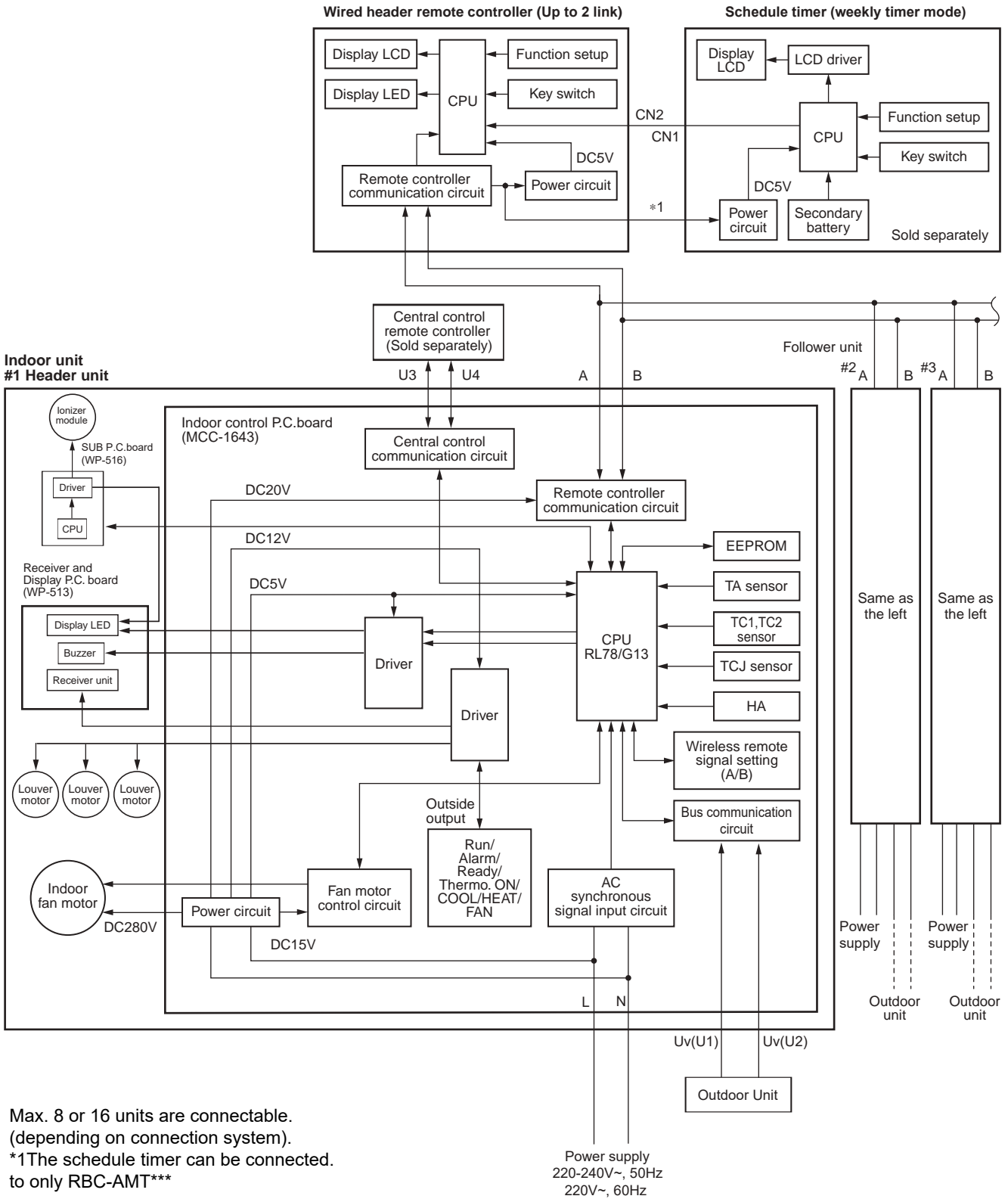

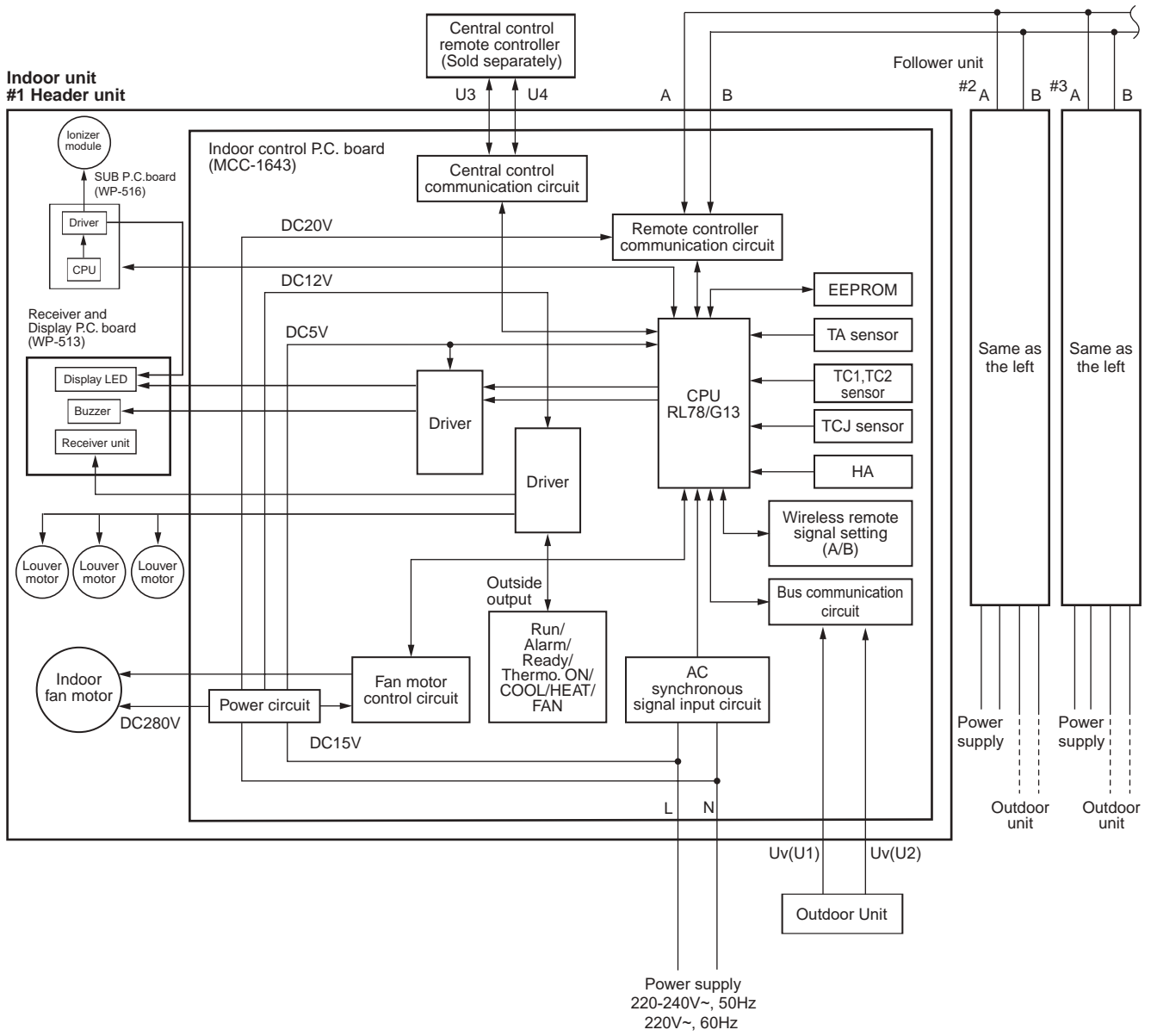

7-2. Indoor P.C. Board (MCC-1643)

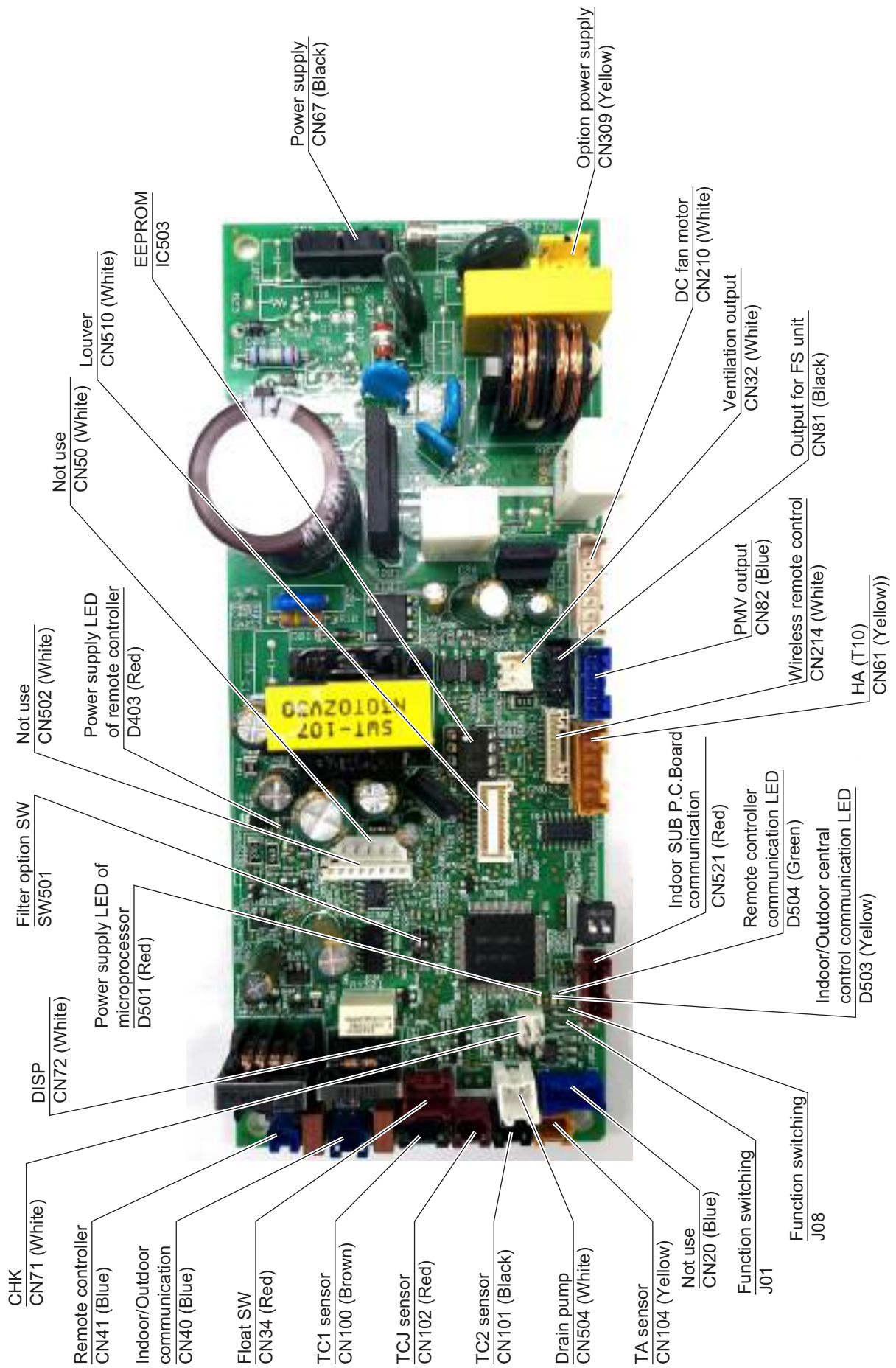

Indoor SUB P.C. Board (WP-516)

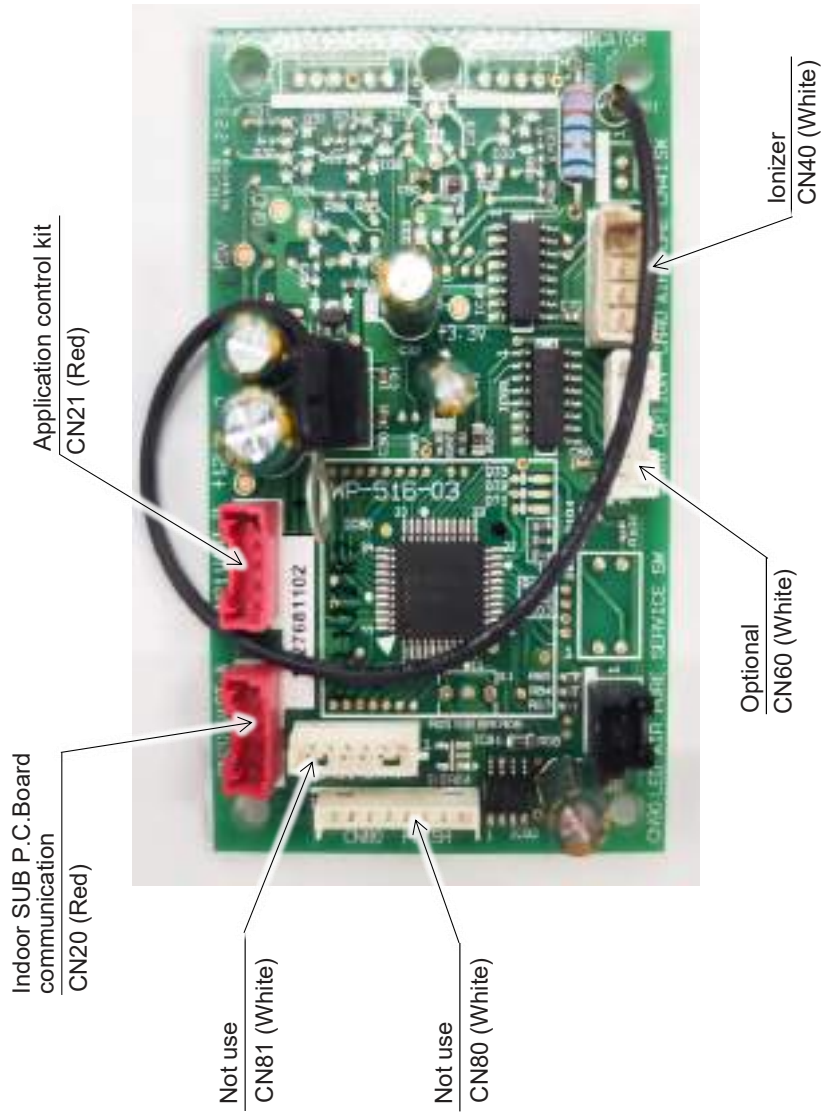

Optional connector specifications of indoor P.C. board (MCC-1643)

Connector No.	Color	Function	High wall	Pin No.	Specifications	Remarks
CN32	White	Ventilation output	○	① ②	DC12V Output (Open collector)	Setting at shipment: Interlock of ON by indoor unit operation, with OFF by stop operation * The single operation setting by FAN button on the remote controller is performed on the remote controller (DN=31).
CN61	Yellow	HA	○	① ② ③ ④ ⑤ ⑥	ON/OFF input 0V (COM) Remote controller prohibited input Operation output (Open collector) DC12V (COM) Warning output (Open collector)	HA ON/OFF input (J01: YES/NO=Pulse (At shipment from factory) /Static input selection) Permission/Prohibition of remote controller operation stop is performed by input. Operation ON (Answer back of HA) Warning output ON
CN71	White	CHK Operation check	○	① ②	Check mode input 0V	This check is used to check indoor operation. (Performs operation of indoor fan "H", Louver horizontal and Drain pump ON without communication with outdoor and remote controller)
CN72	White	DISP Exhibition mode	○	① ②	DISP mode input 0V	Communication is available by indoor unit and remote controller only (When the power is turned on). Shortening time of timer (Always)
CN81	Black	Output for Flow selector unit	△	① ② ③ ④ ⑤	DC12V EP valve output (Open collector) Balance valve output (Open collector) Suction valve output (Open collector) Discharge valve output (Open collector)	
CN309	Yellow	Output power supply for option	○	① ③	AC230V AC230V	This can be used as power supply for option devices.
CN521	Red	Connection for option P.C. board	△	① ② ③ ④ ⑤	DC12V DC5V Send Receive 0V	Connected Sub P.C. Board (WP-516)

● : Use in standard, ○ : Available, △ : Use by connecting parts sold separately, x : Unavailable

* To use the functions operated by CN60, CN80, CN70 and CN73, which are provided for other P.C. board, use the Application control kit (TCB-PCUC2E) sold separately.

7-3. Test run of indoor unit

■ Cooling/Heating test run check

The test run for cooling/heating can be performed from either indoor remote controller or outdoor interface P.C.board. Refer to the Installation Manual and Service Manual of outdoor unit for the procedure of the test run from an outdoor interface P.C.board.

◆ In case of wired remote controller

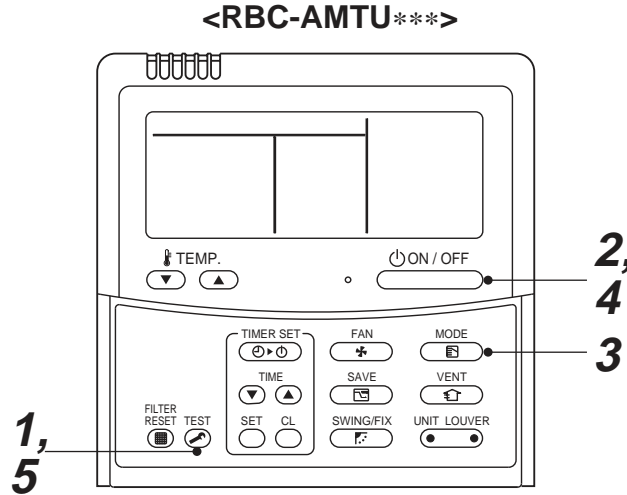

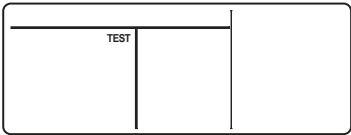
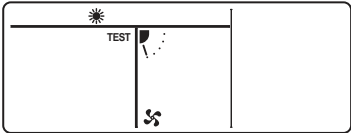
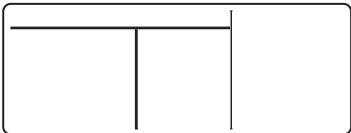
Procedure	Operation contents
1	<p>Push [TEST] button for 4 seconds or more. [TEST] is displayed at the display part and the mode enters in TEST mode.</p> 
2	<p>Push [ON/OFF] button.</p>
3	<p>Change the mode from [COOL] to [HEAT] using [MODE] button.</p> <ul style="list-style-type: none"> • Do not use [MODE] button for other mode except [COOL]/[HEAT] modes. • The temperature cannot be adjusted during test run. • The trouble detection is performed as usual. 
4	<p>After test run, push [ON/OFF] button to stop the operation. (Display on the display part is same to that in Procedure 1.)</p>
5	<p>Push [TEST] button to clear the TEST mode. ([TEST] display in the display part disappears and status becomes the normal stop status.)</p> 

Note) The test run returns to the normal operation after 60 minutes.

<RBC-ASCU11-*>

Be sure to stop the air conditioner before making settings.

(Change the setup while the air conditioner is not working.)

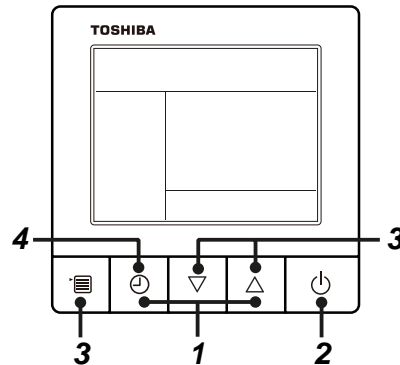

- 1 Push and hold OFF timer button and [Δ] setting button simultaneously for 10 seconds or more. [TEST] is displayed on the display part and the test run is permitted.**

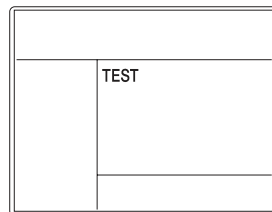

- 2 Push ON/OFF button.**

- 3 Push menu button to select the operation mode. Select [Cool] or [Heat] with [∇] [Δ] setting button.**

- Do not run the air conditioner in a mode other than [Cool] or [Heat].
- The temperature setting function does not work during test run.
- The check code is displayed as usual.

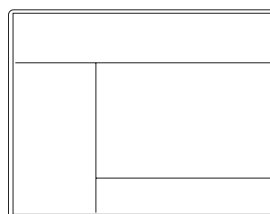

- 4 After the test run, push OFF timer button to stop a test run.**

([TEST] disappears on the display and the air conditioner enters the normal stop mode.)



◆ **In case of wireless remote controller**

1 Turn on the power of the air conditioner.
 When power is turned on for the first time after installation, it takes approx. 5 minutes until the remote controller becomes available. In the case of subsequent power-on, it takes approx. 1 minute until the remote controller becomes available.
 Execute a test run after the predetermined time has passed.

2 Push "ON/OFF" button on the remote controller, select [ Cool] or [ Heat] with "MODE" button, and then select [ HIGH] with "FAN" button.

3

Cooling test run	Heating test run
Set the temperature to 17 °C with the temp. setup buttons.	Set the temperature to 30 °C with the temp. setup buttons.

4

Cooling test run	Heating test run
After confirming a signal receiving sound "beep" immediately set the temperature to 18 °C with the temp. setup buttons.	After confirming a signal receiving sound "beep" immediately set the temperature to 29 °C with the temp. setup buttons.

5

Cooling test run	Heating test run
After confirming a signal receiving sound "beep" immediately set the temperature to 17 °C with the temp. setup buttons.	After confirming a signal receiving sound "beep" immediately set the temperature to 30 °C with the temp. setup buttons.

6 Repeat procedures **4 → 5 → 4 → 5**.
 Indicators "Operation" (green), "Timer" (green), and "Ready" (orange) in the wireless receiver section flash in approx. 10 seconds, and the air conditioner starts operation. If any of these indicators does not flash, repeat procedures 2 to 5.

7 Upon completion of the test run, push "ON/OFF" button to stop operation.

<Overview of test run operations using the wireless remote controller>

▼ Cooling test run:
 ON/OFF → 17 °C → 18 °C → 17 °C → 18 °C → 17 °C → 18 °C → 17 °C → (test run) → ON/OFF

▼ Heating test run:
 ON/OFF → 30 °C → 29 °C → 30 °C → 29 °C → 30 °C → 29 °C → 30 °C → (test run) → ON/OFF

■ Check function for operation of indoor unit (Functions at indoor unit side)

This function is provided to check the operation of the indoor unit singly without communication with the remote controller or the outdoor unit. This function can be used regardless of operation or stop of the system. However, if using this function for a long time, a trouble of the equipment may be caused. Limit using this function within several minutes.

[How to operate]

- 1) Short-circuit CHK pin (CN71 on the indoor P.C. board).
The operation mode differs according to the indoor unit status in that time.
Normal time: Both float SW and fan motor are normal.
Abnormal time: Either one of float SW or fan motor is abnormal.
- 2) Restricted to the normal time, if short-circuiting DISP pin (CN72 on the indoor P.C. board) in addition to short-circuit of CHK pin (CN71 on the indoor P.C. board), the minimum opening degree (30 pls) can be set to the indoor PMV only. (In case connected PMV kit)
When open DISP pin, the maximum opening degree (1500 pls) can be obtained again.
 - For the detailed positions of CHK pin (CN71 on indoor P.C. board) and DISP pin (CN72 on indoor P.C. board), refer to the indoor P.C. board.

[How to clear]

Open CHK pin. While the system is operating, it stops once but automatically returns to operation after several minutes.

	Short-circuit of CHK pin		
	Normal time		Abnormal time
	DISP pin open	DISP pin short circuit	
Fan motor	(H)	(H)	Stop
Indoor PMV (*)	Max. opening degree (1500 pls)	Min. opening degree (30 pls)	Min. opening degree (30 pls)
Louver	Vertical	Vertical	Immediate stop
Communication	All ignored	All ignored	All ignored
P.C. board LED	Lights	Lights	Flashes

* The actual indoor PMV opening degree may differ from the described values due to adjustment depending on PMV types. (In case connected PMV kit)

- To exchange the indoor PMV coil, set the indoor PMV to Max. opening degree.

8. APPLIED CONTROL

8-1. Method to set indoor unit function DN code

(When performing this task, be sure to use a wired remote controller.)

◆ Procedure

Be sure to stop the air conditioner before making settings

<RBC-AMTU***>

- 1 Push the + + buttons simultaneously and hold for at least 4 seconds.
The unit No. displayed first is the address of the header indoor unit in group control.
Then the fan and louver of the selected indoor unit move.
- 2 Each time the button (left side of the button) is pressed, one of the indoor unit Nos. under group control is displayed in turn. Then the fan and louver of the selected indoor unit move.
- 3 Use the to select the CODE No. (DN code) of the desired function.
- 4 Use the to select the desired SET DATA associated with the selected function.
- 5 Push the button. (The display changes from flashing to steady.)
 - To change the selected indoor unit, go back to step 2.
 - To change the selected function, go back to step 3.
- 6 When the button is pushed, the system returns to normal off state.

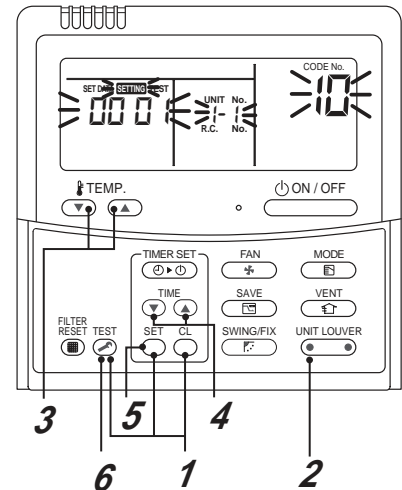

<RBC-ASCU11-*>

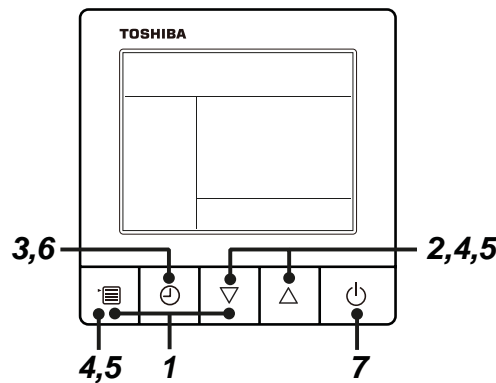

- 1 Push and hold menu button and [] setting button simultaneously for 10 seconds or more.
 - After a while, the display flashes as shown in the figure. "ALL" is displayed as indoor unit numbers during initial communication immediately after the power has been turned on.

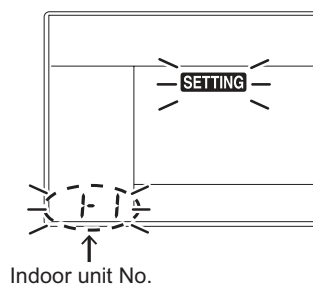

- 2 Each time [] [] setting button is pushed, indoor unit numbers in the group control change cyclically. Select the indoor unit to change settings for.
 - The fan of the selected indoor unit runs. The indoor unit can be confirmed for which to change settings.

3 Push OFF timer button to confirm the selected indoor unit.

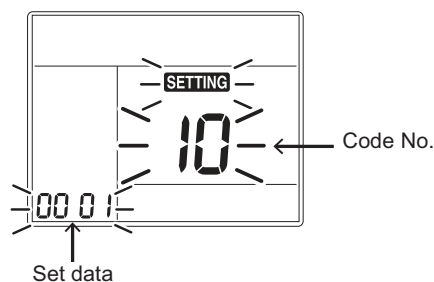

4 Push the menu button to make Code No. [**] flash. Change Code No. [**] with [▽] [△] setting button.

5 Push the menu button to make Set data [**] flash. Change Set data [****] with [▽] [△] setting button.**

6 Push OFF timer button to complete the set up.

- To change other settings of the selected indoor unit, repeat from Procedure **4**.

7 When all the settings have been completed, push ON/OFF button to finish the settings. (Return to the normal mode)

“ **SETTING** ” flashes and then the display content disappears and the air conditioner enters the normal stop mode. (The remote controller is unavailable while “ **SETTING** ” is flashing.)

- To change settings of another indoor unit, repeat from Procedure **1**.

Indoor unit function Code No. (DN Code) table

(includes functions needed to perform applied control on site)

DN	Item	Description	At shipment
01	Filter display delay timer	0000: None 0001: 150H 0002: 2500H 0003: 5000H 0004: 10000H	Depending on model type
02	Dirty state of filter	0000: Standard 0001: High degree of dirt (Half of standard time)	0000: Standard
03	Central control address	0001: No.1 unit to 0064: No.64 unit ... TCC-LINK 0001: No.1 unit to 0128: No.128 unit ... TU2C-LINK 00Un: Unfixed (When using U series remote controller) 0099: Unfixed (Other than U series remote controller)	00Un/0099: Unfixed *1
04	Specific indoor unit priority	0000: No priority 0001: Priority	0000: No priority
06	Heating temp. shift	0000: 0 °C 0001: +1 °C 0002: +2 °C to 0010: +10 °C (Up to +6 recommended)	Depending on model type
0b	Demand control (CN73 / CN4)	0000: Demand input 0001: O2 sensor input 0002: Card input setup.3 0003: Fire alarm input (Normal open) 0004: Card input setup.4 0005: Fire alarm input (Normal close) 0006: Notice cord (202) 0007: Card input setup.5 0008: Card input setup.1 0009: Card input setup.2	0000: Demand input
0d	Existence of [AUTO] mode	0000: Provided 0001: Not provided (Automatic selection from connected outdoor unit)	0001: Not provided
0F	Cooling only	0000: Heat pump 0001: Cooling only (No display of [AUTO] [HEAT])	0000: Heat pump
10	Type	Refer to Type DN code "10" list	Depending on model type
11	Indoor unit capacity	0000: Unfixed 0001 to 0034 Refer to Indoor Unit Capacity DN code "11" list	According to capacity type
12	Line address	0001: No.1 unit to 0064: No.30 unit ... TCC-LINK 0001: No.1 unit to 0128: No.128 unit ... TU2C-LINK 00Un: Unfixed (When using U series remote controller) 0099: Unfixed (Other than U series remote controller)	00Un/0099: Unfixed *1
13	Indoor unit address	0001: No.1 unit to 0064: No.64 unit ... TCC-LINK 0001: No.1 unit to 0128: No.128 unit ... TU2C-LINK 00Un: Unfixed (When using U series remote controller) 0099: Unfixed (Other than U series remote controller)	00Un/0099: Unfixed *1
14	Group address	0000: Individual 0001: Header unit of group 0002: Follower unit of group 00Un: Unfixed (When using U series remote controller) 0099: Unfixed (Other than U series remote controller)	00Un/0099: Unfixed *1
1E	Temp difference of [AUTO] mode selection COOL → HEAT, HEAT → COOL	0000: 0 °C to 0010: 10 °C (Ts ± 5°C) Ts:Remote controller setup temp.	0003: 3 °C (Ts ±1.5 °C)
28	Automatic restart of power failure	0000: None 0001: Restart	0000: None
2A	Selection of option/Trouble input (TCB-PCUC2E: CN3)	0000: Filter input 0001: Alarm input 0002: None (Air washer, etc.)	0002: None
2E	HA terminal (CN61) select	0000: Usual 0001: Card input setup.1 (3) 0002: Fire alarm input (arbiter contact) 0003: Card input setup.2 (4) 0004: Notice cord (201) 0005: Card input setup.5	0000: Usual (HA terminal)
31	Ventilating fan control	0000: Unavailable 0001: Available	0000: Unavailable
32	TA sensor selection	0000: Body TA sensor 0001: Remote controller sensor	0000: Body TA sensor

DN	Item	Description		At shipment
33	Temperature unit select	0000: °C	0001: °F	0000: °C
5d	External static pressure High-ceiling adjustment (Air flow selection)	Refer to next page.		Depending on model type
60	Timer setting (wired remote controller)	0000: Available (can be performed)	0001: Unavailable (cannot be performed)	0000: Available
77	Dual set point	0000: Unavailable	0002: Available	0000: Unavailable
79	Alarm output setup of the header unit	0000: Not including the state of following unit	0001: Including the state of following unit	0000: Not including the state of following unit
b3	Soft cooling	0000: Unavailable	0001: Available	0001: Available
d0	Whether the power saving mode can be set by the remote controller	0000: Invalid	0001: Valid	0001: Valid
E0	Destination	0000: Domestic 0004: Global	0003: China	0004: Global
E6	Wireless remote controller A-B selection	0000: A	0001: B	0000: A
F6	Presence of Application control kit (TCB-PCUC2E)	0000: None	0001: Exist	0000: None
FC	Communication protocol *2	0000: TCC-LINK	0003: TU2C-LINK	0000: TCC-LINK
Fd	Priority operation mode (FS unit)	0000: Heating	0001: Cooling	0000: Heating
FE	FS unit address	0001: No.1 unit to 0064: No.64 unit ... TCC-LINK 0001: No.1 unit to 0128: No.128 unit ... TU2C-LINK 00Un: Unfixed (When using U series remote controller) 0099: Unfixed (Other than U series remote controller)		00Un/0099: Unfixed *1
180	Notice code number 01	0000: None 0001 ~ 0255 : Notice code 0129 : Notice code (201) 0130 : Notice code (202) (0001 ~ 0255 : TU2C-LINK only)		0000: None
181	Notice code number 02			0000: None
182	Notice code number 03			0000: None
183	Notice code number 04			0000: None
184	Notice code number 05			0000: None
185	Notice code number 06			0000: None
186	Notice code number 07			0000: None
187	Notice code number 08			0000: None
188	Notice code number 09			0000: None
189	Notice code number 10			0000: None
103	Remote controller	0000: Use	0001: Do not use	0000 : Use
1A5	Airpure operation control	0000: Standard 0002: Airpure operation 75%	0001: Airpure operation 100% 0003: Airpure operation 50%	0000 : Standard
1FB	Central device control state	0000: No central device control (Remote controller use is possible) 0001: Central device control (Remote controller use is impossible)		0000: No central device control
1FC	Indoor Unit terminating resistance	0000: OFF	0001: ON	0000: OFF

*1 Display order of "00Un" and "0099" varies depending on remote controller models or communication types.

For Central control address (DN [03]), Indoor unit address (DN [13]), FS unit address (DN [FE])

Remote controller	Communication type	Display order
U series	TU2C-LINK	... ⇔ 0128 ⇔ 00Un ⇔ 0001 ⇔ ...
	TCC-LINK	... ⇔ 0064 ⇔ 00Un ⇔ 0001 ⇔ ...
Other than U series	TCC-LINK	... ⇔ 0064 ⇔ 0099 ⇔ 0001 ⇔ ...

For Line address (DN [12])

Remote controller	Communication type	Display order
U series	TU2C-LINK	... ⇔ 0128 ⇔ 00Un ⇔ 0001 ⇔ ...
	TCC-LINK	... ⇔ 0030 ⇔ 00Un ⇔ 0001 ⇔ ...
Other than U series	TCC-LINK	... ⇔ 0030 ⇔ 0099 ⇔ 0001 ⇔ ...

For Group address (DN [14])

Remote controller	Communication type	Display order
U series	TU2C-LINK TCC-LINK	... ⇔ 0002 ⇔ 00Un ⇔ 0000 ⇔ ...
	TCC-LINK	... ⇔ 0002 ⇔ 0099 ⇔ 0000 ⇔ ...

*2 Communication protocol can be automatically switched with the setup in the outdoor unit during installation.

Type

DN code "10"

Value	Type	Model
08	High Wall	MMK-UP0051, 0071, 0091, 0121, 0151, 0181DHPL

Indoor Unit Capacity

DN code "11"

Value	Capacity
0000 *	Disable
0041	0005
0001	0007
0003	0009
0005	0121
0007	0151
0009	0181

8-2. Applied control of indoor unit

■ Control system using Remote location ON/OFF control box (TCB-IFCB-4E2)

Wiring and setting

- In the case of group control, the control system functions as long as it is connected to one of the indoor units (control P.C. board) in the group. If it is desired to access the operation and trouble statuses of other units, relevant signals must be brought to it from those units individually.

1. Control items

- | | |
|-------------------------------|---|
| (1) Start / Stop input signal | Start / stop of unit |
| (2) In-operation signal | Output present while unit in normal operation |
| (3) Check code Output | present while alarm (e.g. serial communication trouble or operation of protective device for indoor / outdoor unit) being activated |

2. Wiring diagram of control system using Remote location ON/OFF control box (TCB-IFCB-4E2)

- Input IFCB-4E2: No-voltage ON / OFF serial signal
- Output No-voltage contact (in-operation and check code indication)
Contact capacity: Max. AC 240 V, 0.5 A

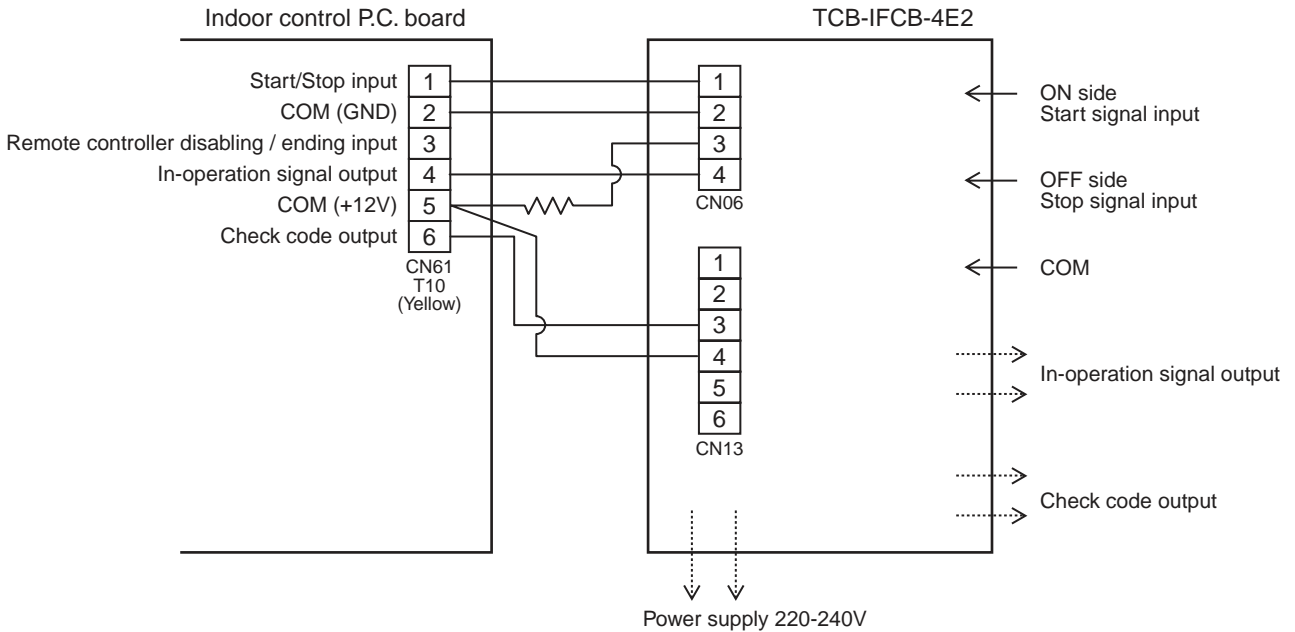

■ Ventilating fan control from remote controller

[Function]

- The start / stop operation can be operated from the wired remote controller when air to air heat exchanger or ventilating fan is installed in the system.
- The fan can be operated even if the indoor unit is not operating.
- Use a fan which can receive the no-voltage normally-open contact as an outside input signal.
- In a group control, the units are collectively operated and they cannot be individually operated.

1. Operation

Handle a wired remote controller in the following procedure.

- * Use the wired remote controller during stop of the system.
- * Be sure to set up the wired remote controller to the header unit. (Same in group control)
- * In a group control, if the wired remote controller is set up to the header unit, both header and follower units are simultaneously operable.

<RBC-AMT***>

- 1 Push concurrently  +  +  buttons for 4 seconds or more.

The unit No. displayed firstly indicates the header indoor unit address in the group control.
In this time, the fan of the selected indoor unit turns on.

- 2 Every pushing  button (left side of the button), the indoor unit numbers in group control are displayed successively.

In this time, the fan of the selected indoor unit only turns on.

- 3 Using the setup temp  or  button, specify the CODE No. 31.

- 4 Using the timer time  or  button, select the SET DATA. (At shipment: 0000)

The setup data are as follows:

SET DATA	Handling of operation of air to air heat exchanger or ventilating fan
0000	Unavailable (At shipment)
0001	Available

- 5 Push  button. (OK if display goes on.)

- To change the selected indoor unit, go to the procedure 2).
- To change the item to be set up, go to the procedure 3).

- 6 Pushing  returns the status to the usual stop status.

- * The ventilating fan control may be unavailable depending on the remote controllers. (RBC-ASCU11-* does not have this function.)

2. Wiring

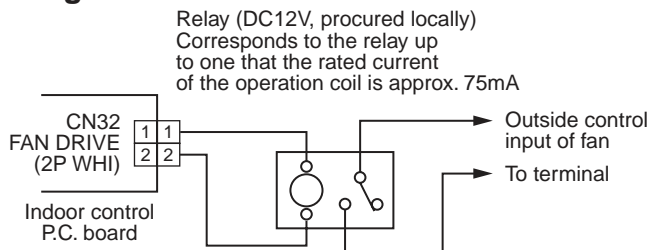

Note) Determine the cable length between the indoor control P.C. board and the relay within 2m.

■ Auto-off feature control

[Function]

- This function controls the indoor units individually. It is used when the start operation from outside is unnecessary but the stop operation is necessary.
 - A card switch box or card lock helps protect customers from forgetting to turn off the indoor unit. (not including the following Card Input 3)
 - It is connected with connector on the indoor control P.C. board, and switched with the Code No. and jumper wire setup for use.
 - Available connectors are CN61 or CN73. For models without CN73, CN4 on the optional Application control kit (TCB-PCUC2E) can be used.
- * Leaving-ON prevention control cannot be set with both CN61 and CN73 (CN4).
If both of them are set, CN73 (CN4) setting automatically turns to a factory default.

[Setup method]

(1) Wiring

Connecting to the CN61 connector

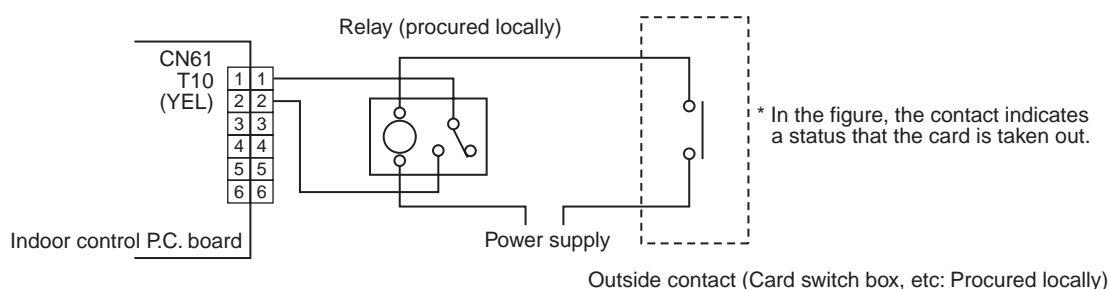

NOTE) Determine the cable length between the indoor control P.C. board and the relay within 3m.

Connecting to the Application control kit (TCB-PCUC2E, connector : CN4)

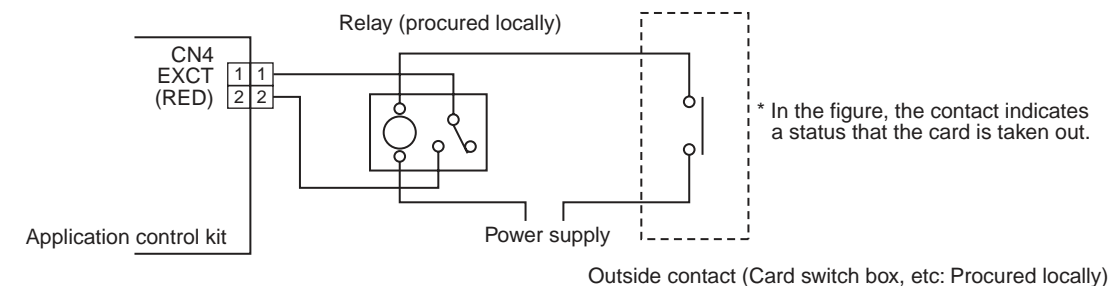

NOTE) Determine the cable length between the indoor control P.C. board and the relay within 3m.

(2) Code (DN) setup

Set Code (DN) according to "8-1. Method to set indoor unit function DN code".

Connector	Jumper wire (J01)	Code No. (DN)	Set data	Function
CN61	Short-circuit (Factory default)	002E	0000 (Factory default)	"HA normal setup" (pulse)
			0001	"Card Input 1" setup
			0003	"Card Input 2" setup
	Open-circuit (cut)		0005	"Card Input 5" setup
			0000 (Factory default)	"HA normal setup" (Static)
			0001	"Card Input 3" setup
CN73 (CN4)	Short-circuit (Factory default) or Open-circuit (cut)	000b	0003	"Card Input 4" setup
			0000 (Factory default)	"EXCT demand" setup (Forced thermostat-OFF)
			0002	"Card Input 3" setup
			0004	"Card Input 4" setup
			0007	"Card Input 5" setup
			0008	"Card Input 1" setup
0009	"Card Input 2" setup			

* If you set "Card Input 1 to 5" for Code No. of CN61 and CN73, Code No. 000b setup becomes unavailable and the functions of Card Input 1 to 5 in CN73 cannot be used.

[Control items]

Function	External contact terminal	
	Close (Status that card is inserted)	Open (Status that card is taken out)
Card Input 1	Manual prohibition release (Manual operation)	Manual prohibition (Operation stop)
Card Input 2	Manual prohibition release (Automatic operation)	Manual prohibition (Operation stop)
Card Input 3	Operation status continues (Do nothing)	Operation status continues and setting temperature changes (COOL/DRY: 29°C, HEAT: 18°C)
Card Input 4	Manual prohibition release (The status returns to operating condition before removing the card.)	Manual prohibition (Operation stop)
Card Input 5	<p>1) To change a setting temperature by changing data at DN code No. 172 to 174.</p> <p>2) The operation mode can be set by changing data (0000, 0001, 0002) at DN code No. 16b.</p> <p>0000: operation mode is the same at the current mode. (factory setting default)</p> <p>0001: operation mode returns to the previous mode when card was inserted. (in case of the previous mode is off operation, the operation mode is also off.)</p> <p>0002: operation mode starts at the same previous mode when the card was inserted. (the operation mode is on operation even the previous mode is off operation.)</p> <p>See contents below for DN settings and detailed operations.</p>	<p>1) To change a setting temperature, fan speed and wind direction by changing data at DN code No. 16C to 171.</p> <p>2) The operation mode can be set by changing data (0000, 0001) at DN code No. 16A.</p> <p>0000: operation mode is the same at the current mode. (factory setting default)</p> <p>0001: operation automatically starts.</p> <p>See contents below for DN settings and detailed operations.</p>

* For the card switch box that does not involve contact operation described above, convert signals with a relay including a normally-closed contact.

[Card input setup.5 Code (DN)]

DN	Item	Description	At shipment
16C	Open mode Set temp. (Cool, Dry)	-0015 : -15°C to 0060 : 60°C	0027 : 27°C
16d	Open mode Set temp. (Heat)	-0015 : -15°C to 0060 : 60°C	0020 : 20°C
16E	Open mode Set temp. (Auto)	-0015 : -15°C to 0060 : 60°C	0024 : 24°C
16F	Open mode Fan speed (All operation mode)	0000 : No change 0001 : HH 0002 : H 0003 : L	0000 : No change
170	Open mode Wind direction (Cool, Dry, Fan)	0000 : No change 0001 : F1 0002 : F2 0003 : F3	0000 : No change
171	Open mode Wind direction (Heat)	0000 : No change 0001 : F1 0002 : F2 0003 : F3 0004 : F4 0005 : F5	0000 : No change
16A	Open mode Operation	0000 : No change 0001 : Run operation	0000 : No change
172	Close mode Set temp. (Cool, Dry)	-0015 : -15°C to 0060 : 60°C	0024 : 24°C
173	Close mode Set temp. (Heat)	-0015 : -15°C to 0060 : 60°C	0024 : 24°C
174	Close mode Set temp. (Heat)	-0015 : -15°C to 0060 : 60°C	0024 : 24°C
16b	Close mode Operation	0000 : No change 0001 : Card ON mode operation 0002 : Run operation (Card ON mode setting)	0000 : No change

[The example of Card Input 5 setting]

Case.	Code No. (DN) setting									External contact terminal	
	[16A] data	[16b] data	[16C] data	[16d] data	[16F] data	[170] data	[171] data	[172] data	[173] data	Close (Status that card is inserted)	Open (Status that card is taken n out)
(1)	0000	0000	0027	0020	0000	0000	0000	0024	0024	<ul style="list-style-type: none"> The operation mode continues running at the same as the current mode. The setting temperature of cooling/dry and heating mode is changed to 24°C and 24°C respectively due to change in code No. 172, 173. 	<ul style="list-style-type: none"> The operation mode continues running at the same as the current mode. The setting temperature of cooling/dry and heating mode is changed to 27°C and 20°C respectively due to change in code No. 16C, 16d.
(2)*	0000	0001	0027	0020	0003	0001	0001	0024	0024	<ul style="list-style-type: none"> The operation mode is running at the same mode as the last time when the card was inserted due to change in code no. 16b. * The operation mode will be off if the mode at the last time was in off operation. Also, the fan speed will the same as the last time when the card is inserted. The setting temperature of cooling/dry and heating mode is changed to 24°C and 24°C respectively due to change in code No. 172, 173. 	<ul style="list-style-type: none"> The operation mode continues running at the same as the current mode. The setting temperature of cooling/dry and heating mode is changed to 27°C and 20°C respectively due to change in code no. 172, 173. The fan speed for all operation modes is changed due to change in code no.16F. The wind direction of Cooling/dry/fan and heating mode are changed due to change in code No. 170, 171 respectively.
(3)*	0000	0002	0027	0020	0003	0001	0001	0024	0024	<ul style="list-style-type: none"> The operation mode is running at the same mode as the last time when the card was inserted. Also, the operation mode will be on even the mode was in off operation at the last time due to change in code no. 16B. * The fan speed will the same as the last time when the card is inserted. The setting temperature of cooling/dry and heating mode is changed to 24°C and 24°C respectively due to change in code No. 172, 173. 	Same operation as case (2)
(4)	0001	0000	0027	0020	0003	0001	0001	0024	0024	<ul style="list-style-type: none"> The operation mode continues running at the same as the current mode. The setting temperature of cooling/dry and heating mode is changed to 24°C and 24°C respectively due to change in code No. 172, 173. 	<ul style="list-style-type: none"> Due to change in code no. 16A, the operation mode will be as below. When the operation is ON, the operation mode will continue running at the same as the current mode. When the operation is OFF, the air conditioner will turn on automatically. The setting temperature of cooling/dry and heating mode is changed to 27°C and 20°C respectively due to change in code No. 172, 173. The fan speed for all operation modes is changed due to change in code no.16F. The wind direction of Cooling/dry/fan and heating mode are changed due to change in code No. 170, 171 respectively.

* The history operation mode is only recorded when the card is inserted even if the operation mode is changed when the card is taken out, there is no related to the history operation mode.

■ Power peak-cut from indoor unit

When the relay is turned on, a forced thermostat OFF operation starts.

- For indoor P.C. boards other than MCC-1643, the "EXCT" is input with connector CN73 on the P.C. board. MCC-1643 requires Application control kit (TCB-PCUC2E) for input of a forced thermostat OFF "EXCT". Please refer to the manual of Application control kit for a detailed setting.

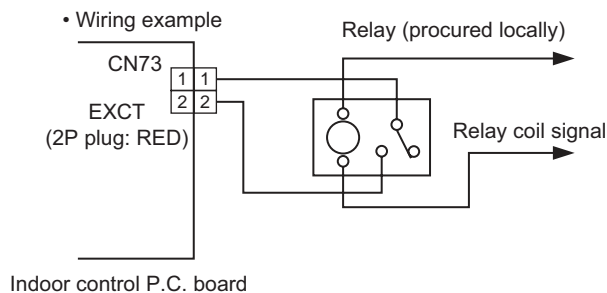

Note) Determine the cable length between the indoor or outdoor control P.C. board and the relay within 2 m.

■ Notice code signal

Notice code is a function dedicated to TU2C-Link communication.
See service manual for u series outdoor unit for details of Notice code.

[Function]

- Notice Code is issued if there is signal input to connector of outdoor unit P.C. board. This can be used in cases such as when confirming state of outdoor unit (filter clogging, etc.) by air conditioner system.
- Connector that can be used is CN61 or CN73. CN4 of separately-sold "option input/output P.C. board (TCB-PCUC2E)" can be used for models that do not have CN73.
- Used by switching functions with settings of Code No. (DN Code).
- Notice Code is continuously issued while input signal is ON.

[Setup method]

(1) Wiring

Connecting to the CN61 connector

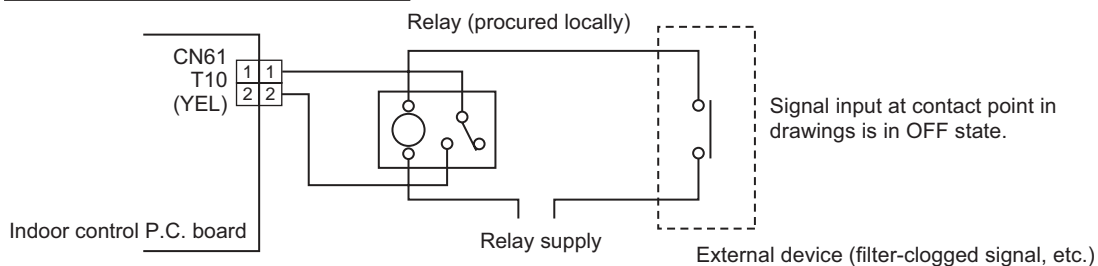

Note) Determine the cable length between the indoor control P.C. board and the relay within 3m.

Connecting to the Application control kit (TCB-PCUC2E, connector : CN4)

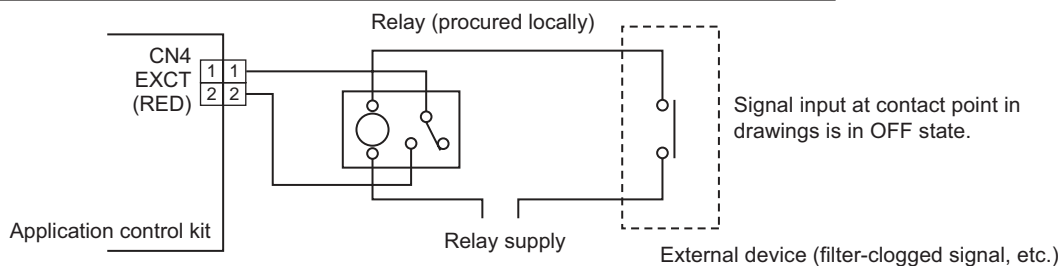

Note) Determine the cable length between the indoor control P.C. board and the relay within 3m.

(2) Code (DN) setup and Notice code

Set Code (DN) according to "8-1. Method to set indoor unit function DN code".

Connector	Code No. (DN)	Set data	Notice code
CN61	002E	0004	201
CN73 (CN4)	000B	0006	202

* Setting of Code No. (DN Code) is necessary to display Notice code mark at remote controller.
Set data corresponding to Notice code to be used to one of Code No. 180 to 189, in accordance with following table.
In case where data other than 0000 is already set, set to other Code No. (DN Code).

Code No. (DN)	Set data	Notice code
0180	0000	OFF (Factory default)
to	0129	201
0189	0130	202

* It may take up to ten minutes to be displayed on remote controller after Notice code is issued.

Manual address setting using the remote controller

Procedure when setting indoor units' addresses first under the condition that indoor wiring has been completed and outdoor wiring has not been started (manual setting using the remote controller)

▼ Wiring example of 2 refrigerant lines

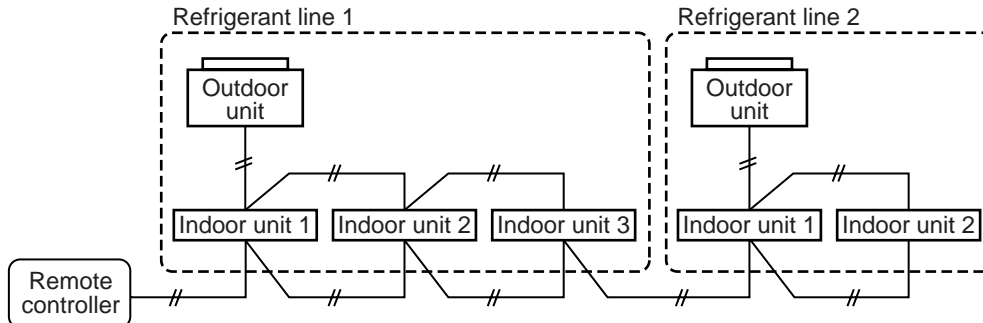

Line (system) address	1	1	1	2	2
Indoor unit address	1	2	3	1	2
Group address	1 Header unit	2 Follower unit	2 Follower unit	2 Follower unit	2 Follower unit

In the example above, disconnect the remote controller connections between the indoor units and connect a wired remote controller to the target unit directly before address setting.

<RBC-AMTU***>

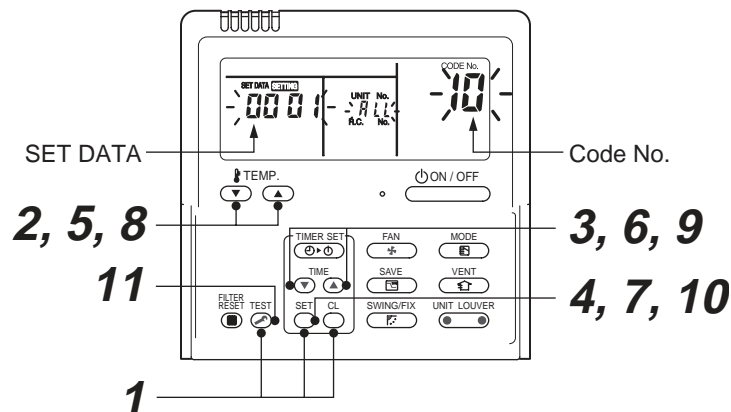

Pair the indoor unit to set and the remote controller one-to-one.

Turn on the power.

- 1 Push and hold the **SET**, **CL** and **TEST** buttons at the same time for more than 4 seconds.
LCD starts flashing.

<Line (system) address>

- 2 Push the **TEMP.** **▼** / **▲** buttons repeatedly to set the **CODE No.** to **12**.
- 3 Push the **TIME** **▼** / **▲** buttons repeatedly to set a system address.
(Match the address with the address on the interface P.C. board of the header outdoor unit in the same refrigerant line.)
- 4 Push **SET** button.
(It is OK if the display turns on.)

<Indoor unit address>

- 5 Push the TEMP. (▼) / (▲) buttons repeatedly to set the CODE No. to 13.
- 6 Push the TIME (▼) / (▲) buttons repeatedly to set an indoor unit address.
- 7 Push the SET button.
(It is OK if the display turns on.)

<Group address>

- 8 Push the TEMP. (▼) / (▲) buttons repeatedly to set the CODE No. to 14.
- 9 Push the TIME (▼) / (▲) buttons repeatedly to set a group address. If the indoor unit is individual, set the address to 0000 ; header unit, 0001 ; follower unit, 0002 .

Individual	: 0000	} In case of group control
Header unit	: 0001	
Follower unit	: 0002	

- 10 Push the SET button.
(It is OK if the display turns on.)
- 11 Push the TEST button.
The address setting is complete.
(SETTING flashes. You can control the unit after SETTING has disappeared.)

<RBC-ASCU11-*>

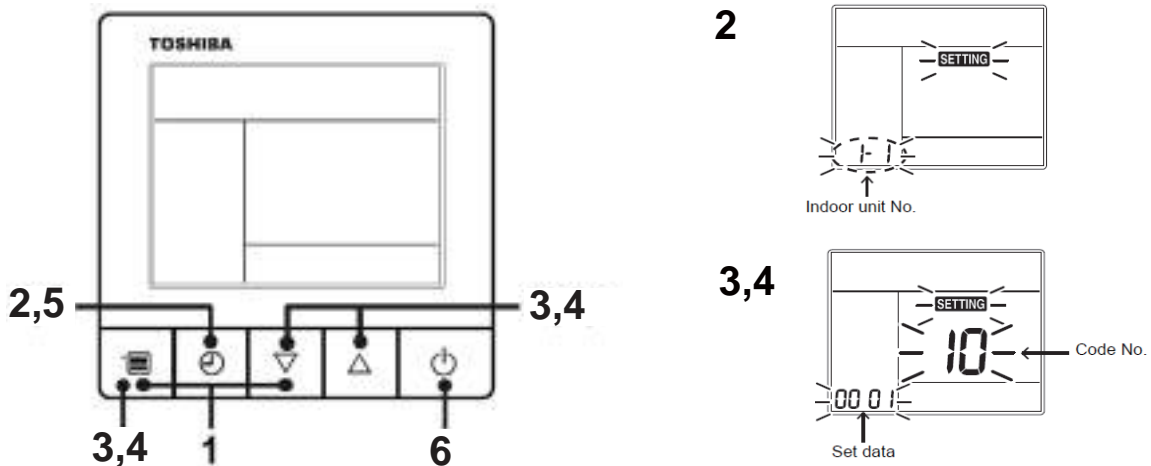

- 1 Push and hold the [menu + ▼] buttons at same time for more than 10 seconds.
- 2 Push the [OFF timer] button to confirm the selected indoor unit.

<Line (system) address>

- 3 Push the [menu] button until the CODE No. flashes. And using the [▼ or ▲] buttons, specify the CODE No.12.
- 4 Push the [menu] button until the SET DATA flashes. And using the [▼ or ▲] buttons, set a system address.
- 5 Push the [OFF timer] button to confirm the SET DATA.

<Indoor unit address>

- 3** Push the [menu] button until the CODE No. flashes. And using the [▽ or △] buttons, specify the CODE No.13.
- 4** Push the [menu] button until the SET DATA flashes. And using the [▽ or △] buttons, set an indoor unit address.
- 5** Push the [OFF timer] button to confirm the SET DATA.

<Group address>

- 3** Push the [menu] button until the CODE No. flashes. And using the [▽ or △] buttons, specify the CODE No.14.
- 4** Push the [menu] button until the SET DATA flashes. And using the [▽ or △] buttons, set a group address.
If the indoor unit is individual, set the address to 0000. (header unit : 0001, follower unit : 0002)
Individual :0000
Header unit :0001 } In case of group control
Follower unit :0002 }
- 5** Push the [OFF timer] button to confirm the SET DATA.
- 6** When all the settings have been completed, push the [ON/OFF] button to return to normal mode.

NOTE

<In the case of combining with outdoor units of Super Modular Multi System u series (SMMS-u)>

- Turn ON DIP switch 1 of SW100 on the header outdoor unit interface P.C. board the lowest system address number.
- After finishing all the settings above, set the address of the central control devices. (For the setting of the central control address, refer to the installation manual of the central control devices.)

<In the case of combining with outdoor units other than Super Modular Multi System u series (SMMS-u)>

- Set a system address for the header outdoor unit of each line with SW13 and 14 of their interface P.C. boards.
- Turn off dip switch 2 of SW30 on the interface P.C. boards of all the header outdoor units connected to the same central control, except the unit that has the lowest address. (For unifying the termination of the wiring for the central control of indoor and outdoor units)
- Connect the relay connectors between the [U1, U2] and [U3, U4] terminals on the header outdoor unit of each refrigerate line.
- After finishing all the settings above, set the address of the central control devices. (For the setting of the central control address, refer to the installation manuals of the central control devices.)

■ Confirming the indoor unit addresses and the position of an indoor unit using the remote controller

◆ Confirming the numbers and positions of indoor units

To know the indoor unit addresses though position of the indoor unit is recognized

- ▼ When the unit is individual (the indoor unit is paired with a wired remote controller one-to-one), or it is a group-controlled one.

<RBC-AMTU***>

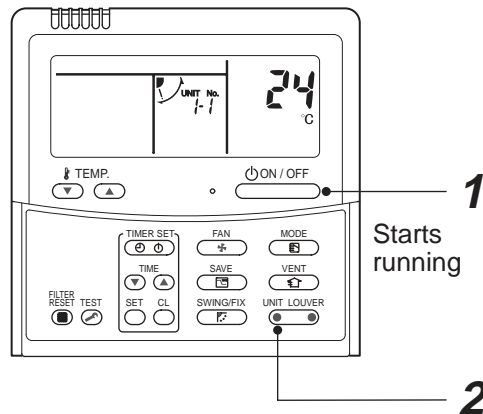

(Execute it while the units are running.)

- 1 Push the  button if the units stop.
- 2 Push the  button (left side of the button).

A unit numbers **1-1** is indicated on the LCD (it will disappear after a few seconds). The indicated number shows the system address and indoor unit address of the unit.

When 2 or more indoor units are connected to the remote controller (group-controlled units), a number of other connected units appears each time you push the  button (left side of the button).

<RBC-ASCU11-*>

There is no such function in the remote controller.

◆ To find an indoor unit's position from its address



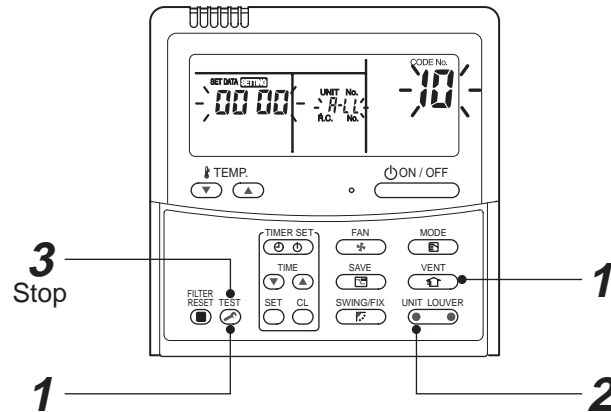

▼ When checking unit numbers controlled as a group

<RBC-AMTU***>



(Execute it while the units are stopped.)

The indoor unit numbers in a group are indicated one after another. The fan and louvers of the indicated units are activated.

- 1** Push and hold the  and  buttons at the same time for more than 4 seconds.
 - **ALL** appears on UNIT No. on the LCD display.
 - The fans and louvers of all the indoor units in the group are activated.
- 2** Push the  button (left side of the button). Each time you push the button, the indoor unit numbers are indicated one after another.
 - The first-indicated unit number is the address of the header unit.
 - Only the fan and louvers of the indicated indoor unit are activated.
- 3** Push the  button to finish the procedure.

All the indoor units in the group stop.

- ▼ To check all the indoor unit addresses using an arbitrary wired remote controller.
(When communication wirings of 2 or more refrigerant lines are interconnected for central control)

<RBC-AMTU***>

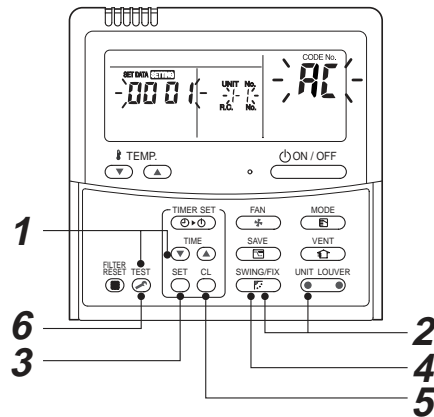

(Execute it while the units are stopped.)

You can check indoor unit addresses and positions of the indoor units in a single refrigerant line. When an outdoor unit is selected, the indoor unit numbers of the selected unit are indicated one after another and the fan and louvers of the indicated indoor units are activated.

- 1** Push and hold the TIME and buttons at the same time for more than 4 seconds. At first, the line 1 and CODE No. (Address Change) are indicated on the LCD display. (Select an outdoor unit.)
- 2** Push the button (left side of the button) and buttons repeatedly to select a system address.
- 3** Push the button to confirm the system address selection.
 - The address of an indoor unit connected to the selected refrigerant line is indicated on the LCD display and its fan and louvers are activated.
- 4** Push the button (left side of the button). Each time you push the button, the indoor unit numbers of the selected refrigerant line are indicated one after another.
 - ◇ • Only the fan and louvers of the indicated indoor unit are activated.
- ◆ **To select another system address**
- 5** Push the button to return to step 2.
 - After returning to step 2, select another system address and check the indoor unit addresses of the line.
- 6** Push the button to finish the procedure.

<RBC-ASCU11-*>

There is no such function in the remote controller.

<RBC-ASCU11-*>

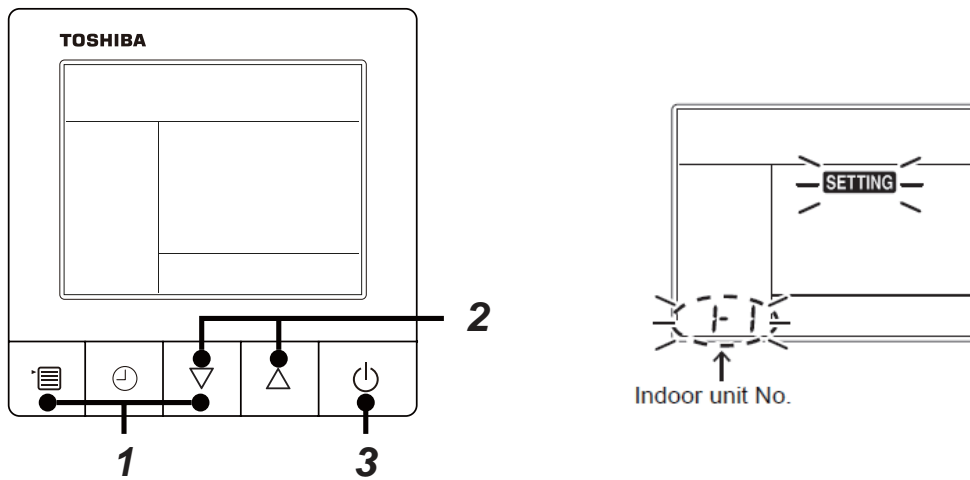

- 1** Push and hold the [menu + ▽] buttons at same time for more than 10 seconds.
e.g.)A unit number 1-1 is indicated on the LCD. The indicated number shows the system address and indoor unit address of the unit.
- 2** When 2 or more indoor units are connected to the remote controller (group-controlled units), a number of other connected units appears each time you push the [▽ or △] buttons.
- 3** Push the [ON/OFF] button, return to the normal mode.

◆ Changing the indoor unit address using a remote controller

To change an indoor unit address using a wired remote controller.

- ▼ The method to change the address of an individual indoor unit (the indoor unit is paired with a wired remote controller one-to-one), or an indoor unit in a group. (The method is available when the addresses have already been set automatically.)

<RBC-AMTU***>

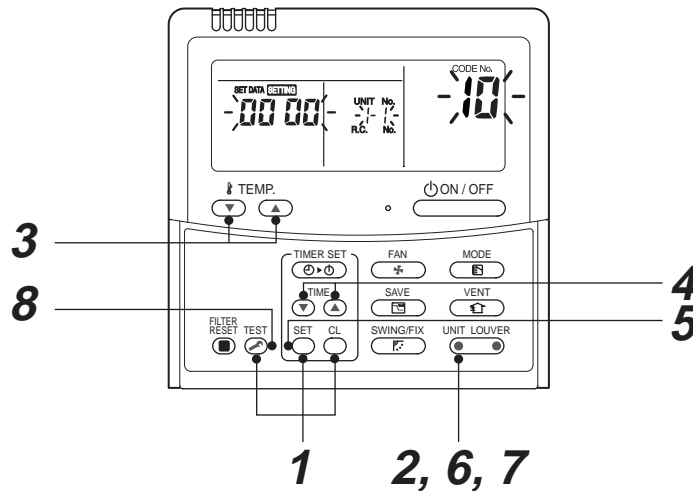

(Execute it while the units are stopped.)

- 1 Push and hold the , , and buttons at the same time for more than 4 seconds. (If 2 or more indoor units are controlled in a group, the first indicated UNIT No. is that of the head unit.)
- 2 Push the button (left side of the button) repeatedly to select an indoor unit number to change if 2 or more units are controlled in a group. (The fan and louvers of the selected indoor unit are activated.) (The fan of the selected indoor unit is turned on.)
- 3 Push the TEMP. / buttons repeatedly to select for CODE No.
- 4 Push the TIME / buttons repeatedly to change the value indicated in the SET DATA section to that you want.
- 5 Push the button.
- 6 Push the button (left side of the button) repeatedly to select another indoor UNIT No. to change. Repeat steps 4 to 6 to change the indoor unit addresses so as to make each of them unique.
- 7 Push the button (left side of the button) to check the changed addresses.
- 8 If the addresses have been changed correctly, push the button to finish the procedure.

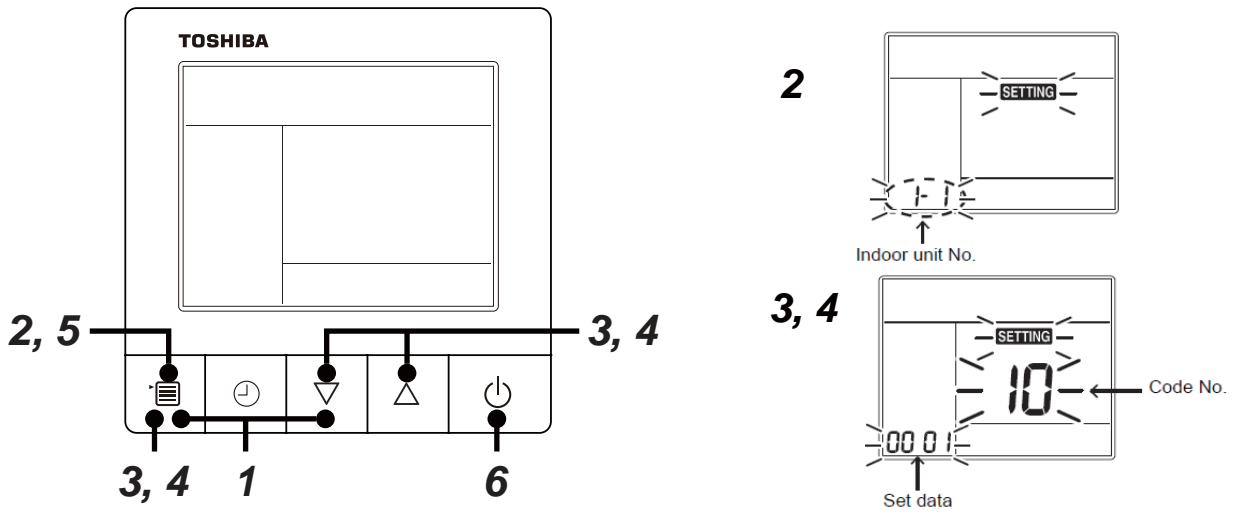

- 1** Push and hold the [menu + ▽] buttons at same time for more than 10 seconds.
- 2** Push the [OFF timer] button to confirm the selected indoor unit.
- 3** Push the [menu] button until the CODE No. flashes. And using the [▽ or △] buttons, specify the CODE No.13.
- 4** Push the [menu] button until the SET DATA flashes. And using the [▽ or △] buttons, set an indoor unit address.
- 5** Push the [OFF timer] button to confirm the SET DATA.
- 6** When all the settings have been completed, push the [ON/OFF] button, return to normal mode.

- ▼ To change all the indoor unit addresses using an arbitrary wired remote controller. (The method is available when the addresses have already been set automatically.)

(When communication wirings of 2 or more refrigerant lines are interconnected for central control)

NOTE
You can change the addresses of indoor units in each refrigerant line using an arbitrary wired remote controller.

* Enter the address check / change mode and change the addresses.

<RBC-AMTU*>**

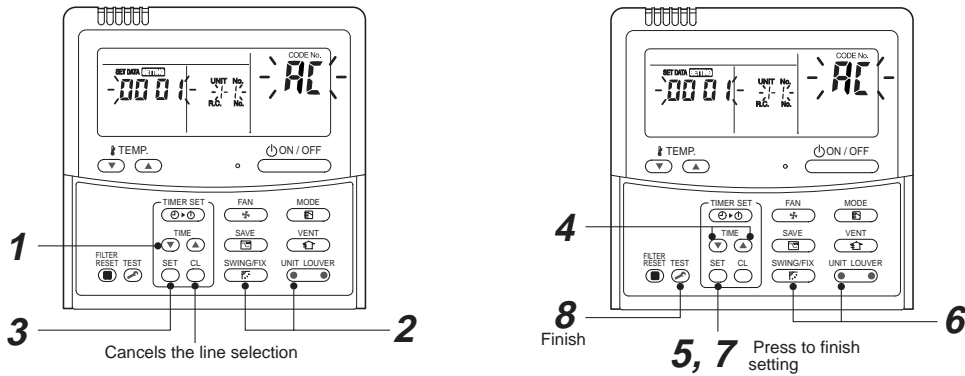

If no number appears on UNIT No., no outdoor unit exists on the line. Push button and select another line following step 2.

(Execute it while the units are stopped.)

- 1 Push and hold the TIME (▼) / (▲) buttons at the same time for more than 4 seconds. At first, the line 1 and CODE No. **AC** (Address Change) are indicated on the LCD display.
- 2 Push the **UNIT LOUVER** button (left side of the button) and the **SWING/FIX** buttons repeatedly to select a system address.
- 3 Push the **SET** button.
 - The address of one of the indoor units connected to the selected refrigerant line is indicated on the LCD display and the fan and louvers of the unit are activated. At first, the current indoor unit address is displayed in SET DATA. (No system address is indicated.)
- 4 Push the TIME (▼) / (▲) buttons repeatedly to change the value of the indoor unit address in SET DATA. Change the value in SET DATA to that of a new address.
- 5 Push the **SET** button to confirm the new address on SET DATA.
- 6 Push the **UNIT LOUVER** button (left side of the button) repeatedly to select another address to change. Each time you push the button, the indoor unit numbers in a refrigerant line are indicated one after another. Only the fan and louvers of the selected indoor unit are activated. Repeat steps 4 to 6 to change the indoor unit addresses so as to make each of them unique.
- 7 Push the **SET** button. (All the segments on the LCD display light up.)
- 8 Push the **TEST** button to finish the procedure.

<RBC-ASCU11-*>

There is no such function in the remote controller.

◆ Check code clearing function

How to clear the check code using the wired remote controller

<RBC-AMTU***>

▼ Clearing a check code of the outdoor unit

Clear the currently detected outdoor unit for each refrigerant line to which the indoor unit controlled by the remote controller is connected. (The indoor unit check code is not cleared.) Use the service monitoring function of the remote controller.

- 1 Push and hold the **CL** , and **TEST** for 4 seconds or longer to enter the service monitoring mode.
- 2 Push the **TEMP.** button to set CODE No. to "FF".
- 3 The display in A of the following figure counts down as follows at 5-second intervals: "0005" → "0004" → "0003" → "0002" → "0001" → "0000".
The check code is cleared when "0000" appears.
However, the display counts down from "0005" again.
- 4 Push the **TEST** to return the display to normal.

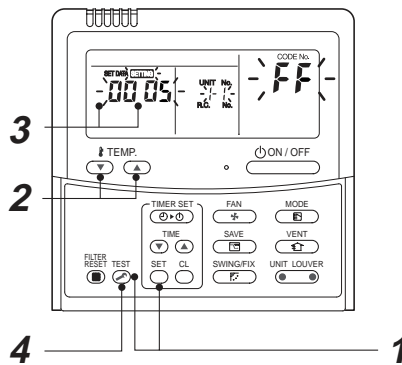

▼ Clearing a check code of the indoor unit

Push the **ON/OFF** button on the remote controller.

(Only the check code of the indoor unit controlled by the remote controller will be cleared.)

<RBC-ASCU11-*>

▼ Clearing a check code of the outdoor unit

Clear the currently detected outdoor unit for each refrigerant line to which the indoor unit controlled by the remote controller is connected. (The indoor unit check code is not cleared.)
Use the service monitoring function of the remote controller.

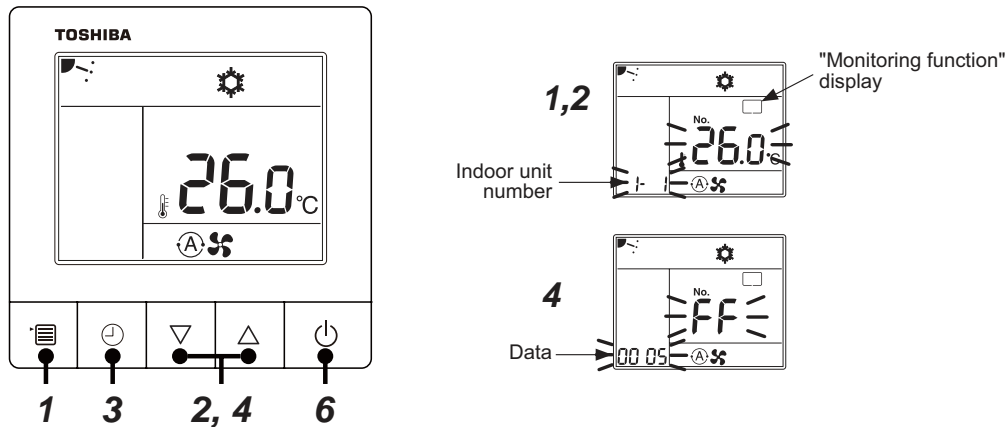

1 Push the [menu] button for over 10 seconds.

2 Every pushing [▽ or △] buttons, the indoor unit numbers in group control are displayed successively.

3 Push the [OFF timer] button to confirm the selected indoor unit.

4 Every pushing [▽ or △] buttons to set CODE No. to "FF"

5 The display in A of the following figure counts down as follows at 5-second intervals:
"0005" → "0004" → "0003" → "0002" → "0001" → "0000"

The check code is cleared when "000" appears.

However, the display counts down from "005" again.

6 After you have finished checking, push the [ON/OFF] button to return to normal mode.

▼ Clearing a check code of the indoor unit

Push the ON / OFF button on the remote controller.

(Only the check code of the indoor unit controlled by the remote controller will be cleared.)



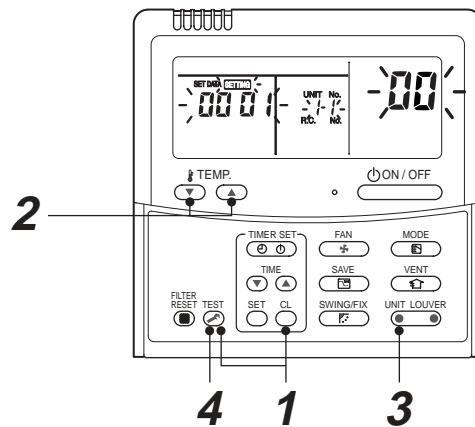

▼ Monitoring function of wired remote controller

<RBC-AMTU***>



Content

Enter the service monitoring mode using the remote controller to check the sensor temperature or operation status of the remote controller, indoor unit, and outdoor unit.

- 1 Push and hold the , and  for 4 seconds or longer to enter the service monitoring mode. The service monitor lights up. The CODE No. **00** appears at first.
- 2 Push the  button to change to CODE No. of the item to monitor. Refer to the next page for CODE No.
- 3 Push the left part of the  button (left side of the button) to change to the item to monitor. Monitor the sensor temperature or operation status of the indoor unit and outdoor unit in the refrigerant line.
- 4 Push the  button to return the display to normal.

<RBC-ASCU11-*>

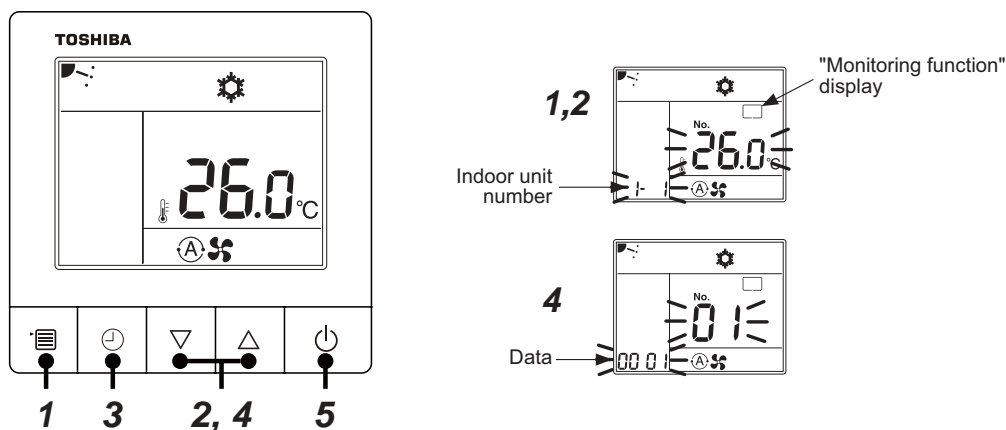

- 1 Push the [menu] button for over 10 seconds. "Monitoring function" is displayed on a screen.
- 2 Every pushing [▽ or △] buttons, the indoor unit numbers in group control are displayed successively.
- 3 Push the [OFF timer] button to confirm the selected indoor unit.
- 4 Every pushing [▽ or △] buttons, CODE No. of the item is changed successively.
- 5 After you have finished checking, push the [ON/OFF] button, return to normal mode.

◆ Indoor service monitor list

	Code No.	Data name	Display format	Unit	Remote controller display example
Indoor unit data *	00	Room temperature (Use to control)	x1	°C	
	01	Room temperature (Remote controller)	x1	°C	
	02	Indoor suction air temperature (TA)	x1	°C	
	03	Indoor coil temperature (TCJ)	x1	°C	
	04	Indoor coil temperature (TC2)	x1	°C	
	05	Indoor coil temperature (TC1)	x1	°C	
	06	Indoor discharge air temperature (TF) **	x1	°C	
	07	Indoor fan motor number of revolutions**	x1	rpm	[0600] = 600rpm
	08	Indoor PMV opening	x1/10	pls	[0150]=1500pls
	F3	Filter sign time	x1	h	[2500] = 2500h
	F9	Suction temperature of air to air heat exchanger (TSA) **	x1	°C	[0024] = 24°C
	FA	Outside air temperature (TOA) **	x1	°C	

* When the units are connected to a group, data of the header indoor unit only can be displayed.

** There is also a model which cannot be displayed.

- Refer to the service manual of an outdoor unit for "outdoor service monitor list".

9. TROUBLESHOOTING

9-1. Overview

(1) Before engaging in troubleshooting

(a) Applicable models

All Super Modular Multi System (SMMS-*) models.

(Indoor units: MM*-UP***, Outdoor units: MMY-M*P***)

(b) Tools and measuring devices required

- Screwdrivers (Philips, flat head), spanners, long-nose pliers, nipper, pin to push reset switch, etc.
- Multimeter, thermometer, pressure gauge, etc.

(c) Things to check prior to troubleshooting (behaviors listed below are normal)

NO.	Behavior	Possible cause
1	A compressor would not start	<ul style="list-style-type: none"> • The air conditioner is being controlled by the 3-minute protective function. • It is in standby status though the room temperature has reached the setup temperature. • It is being operated in timer mode or fan mode. • It is being in initial communication.
2	An indoor fan would not start	<ul style="list-style-type: none"> • The air conditioner is being controlled by the cool air discharge preventive function in "heating"?
3	An outdoor fan would not start or would change speed for no reason	<ul style="list-style-type: none"> • The air conditioner is being operated in "cooling" under the low outside air temperature. • It is being operated in defrost operation.
4	An indoor fan would not stop	<ul style="list-style-type: none"> • The air conditioner is being controlled by function of residual heat elimination being performed as part of the air conditioner shutdown process after heating operation.
5	The air conditioner would not respond to a start/stop command from a remote controller	<ul style="list-style-type: none"> • The air conditioner is being operated under external or remote controller.

CAUTION

The cooling performance may be declining considerably when total operating capacity of cooling indoor units is less than 4 HP while ambient temperature is below.

(2) Troubleshooting procedure

When a problem occurs, proceed with troubleshooting in accordance with the procedure shown below.

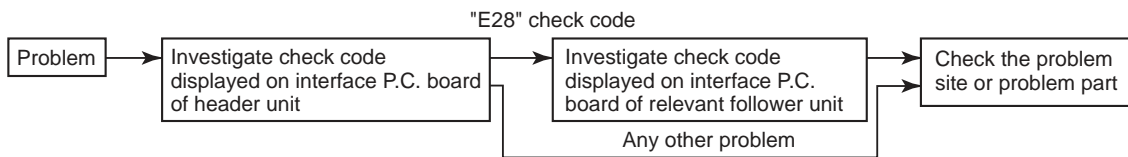

NOTE

Rather than a product trouble (see the List of Check Codes below), the problem could have been caused by a microprocessor malfunction attributable to a poor quality of the power source or an external noise. Check for possible noise sources, and shield the remote controller wiring and signal wires as necessary.

9-2. Troubleshooting method

The remote controllers (main remote controller and central control device) and the interface P.C. board of an outdoor unit are provided with an a 7-segment display (outdoor interface P.C. board) to display operational status. Using this self-diagnosis feature, the trouble site / trouble part may be identified in the event of a trouble by following the method described below.

The list below summarizes check codes detected by various devices. Analyze the check code according to where it is displayed and work out the nature of the trouble in consultation with the list.

- When investigating a trouble on the basis of a display provided on the indoor remote controller or central control device - See the “central control device or main remote controller display” section of the list.
- When investigating a trouble on the basis of a display provided on an outdoor unit - See the “Outdoor 7-segment display” section of the list.
- When investigating a trouble on the basis of a wireless remote controller-controlled indoor unit - See the “Indicator light block” section of the list.

List of check codes (indoor unit)

(Check code detected by indoor unit)

IPDU: Compressor / Fan inverter P.C. board

○: Lighting, ⊙: Flashing, ●: Goes off

ALT.: Flashing is alternately when there are two flashing LED

SIM: Simultaneous flashing when there are two flashing LED

Check code			Display of receiving unit				Typical trouble on site	Description of check code
Remote controller display	Outdoor 7-segment display		Indicator light block					
		Sub-code	Operation ⏻	Timer ⌚	Ready ⊙	Flash		
E03	—	—	⊙	●	●		Indoor-remote controller periodic communication check code	Communication from remote controller or network adaptor has been lost (so has central control communication).
E04	—	—	●	●	⊙		Indoor-outdoor periodic communication check code	Signals are not being received from outdoor unit.
E08	E08	Duplicated indoor address	⊙	●	●		Duplicated indoor address	Indoor unit detects address identical to its own.
E10	—	—	⊙	●	●		Communication trouble between indoor unit MCU	Communication trouble between main MCU and the motor microcomputer MCU
E11	—	—	⊙	●	●		Communication check code between Application control kit and indoor unit	Communication check code between Application control kit and indoor unit P.C. board
E18	—	—	⊙	●	●		Check cod in periodic communication between indoor header and follower unit	Periodic communication between indoor header and follower units cannot be maintained.
F01	—	—	⊙	⊙	●	ALT	Indoor heat exchanger temperature sensor (TCJ) check code	Heat exchanger temperature sensor (TCJ) has been open / short-circuit.
F02	—	—	⊙	⊙	●	ALT	Indoor heat exchanger temperature sensor (TC2) check code	Heat exchanger temperature sensor (TC2) has been open / short-circuit.
F03	—	—	⊙	⊙	●	ALT	Indoor heat exchanger temperature sensor (TC1) check code	Heat exchanger temperature sensor (TC1) has been open / short-circuit.
F10	—	—	⊙	⊙	●	ALT	Ambient temperature sensor (TA) check code	Ambient temperature sensor (TA) has been open / short-circuit.
F11	—	—	⊙	⊙	●	ALT	Discharge temperature sensor (TF) check code	Discharge temperature sensor (TF) has been open / short-circuit.
F29	—	—	⊙	⊙	●	SIM	P.C. board or other indoor check code	Indoor EEPROM is abnormal (some other trouble may be detected).
F30	—	—	⊙	⊙	○	ALT	Occupancy sensor trouble	Occupancy sensor trouble has been detected.
L03	—	—	⊙	●	⊙	SIM	Duplicated indoor group header unit	There is more than one header unit in group.
L07	—	—	⊙	●	⊙	SIM	Connection of group control cable to a single indoor unit	There is at least one a single indoor unit to which group control cable is connected.
L08	L08	—	⊙	●	⊙	SIM	Indoor group address not set	Address setting has not been performed for one or more indoor units (also detected at outdoor unit end).
L09	—	—	⊙	●	⊙	SIM	Indoor capacity not set	Capacity setting has not been performed for indoor unit.
L20	—	—	⊙	○	⊙	SIM	Duplicated central control address	There is duplication in central control address setting.
L30	L30	Detected indoor unit No.	⊙	○	⊙	SIM	Indoor external check code input (interlock)	Unit shutdown has been caused by external check code input (CN80).
P01	—	—	●	⊙	⊙	ALT	Indoor AC fan check code	Indoor AC fan check code is detected (activation of fan motor thermal relay).
P10	P10	Detected indoor unit No.	●	⊙	⊙	ALT	Indoor overflow check code	Float switch has been activated.
P12	—	—	●	⊙	⊙	ALT	Indoor DC fan check code	• Indoor DC fan check code (e.g. overcurrent or lock-up) is detected.
P31	—	—	⊙	●	⊙	ALT	Other indoor unit check code	Follower unit cannot be operated due to header unit alarm (E03 / L03 / L07 / L08).

(Check code detected by remote controller)

Check code			Display of receiving unit				Typical trouble site	Description of trouble
Remote control	Outdoor 7-segment display		Indicator light block					
		Sub-code	Operation ⏻	Timer ⌚	Ready ⊗	Flash		
E01	-	-	⊙	●	●		No master remote control, failure remote control communication (reception)	Signals cannot be received from indoor unit; master remote control has not been set (including two remote control).
E02	-	-	⊙	●	●		Failure remote control communication (transmission)	Signals cannot be transmitted to indoor unit.
E09	-	-	⊙	●	●		Duplicated master remote control	Both remote controls have been set as master remote control in two remote control (alarm and shutdown for header unit and continued operation for follower unit)

(Check code detected by central control device)

Check code			Display of receiving unit				Typical trouble site	Description of trouble
Central control	Outdoor 7-segment display		Indicator light block					
		Sub-code	Operation ⏻	Timer ⌚	Ready ⊗	Flash		
C05	-	-	No indication (when main remote control also in use)				Failure central control communication (transmission)	Central control device is unable to transmit signal due to duplication of central control device
C06	-	-					Failure central control communication (reception)	Central control device is unable to receive signal.
C12	-	-	-				Bracket alarm for general-purpose device control interface	Device connected to general-purpose device control interface is trouble.
P30 (L20)	-	-	(L20 is displayed.)				Communication Link	<ul style="list-style-type: none"> Duplication addresses of indoor units in central control device With the combination of air conditioning system, the indoor unit may detect the check code of L20

Note: The same trouble, e.g. a communication trouble, may result in the display of different check codes depending on the device that detects it. Moreover, check codes detected by the main remote controller / central control device do not necessarily have a direct impact on air conditioner operation.

Flow selector unit (FS unit) Relation

(Check code detected by indoor unit)

Check code			Display of receiving unit				Typical trouble site	Description of trouble
Main remote control	Outdoor 7-segment display		Indicator light block					
		Sub-code	Operation ⏻	Timer ⌚	Ready ⊗	Flash		
E17	-	-	⊙	●	●		Communication trouble between indoor unit (s) and FS unit (s)	There is no communication from FS unit(s)
J03	-	-	●	⊙	⊙		Duplicated FS units	More than one FS units have been set up in one refrigerant line.
J10	-	-	●	⊙	⊙		FS unit overflow trouble	FS unit has been shutdown in one refrigerant line due to detection of overflow
J11	-	-	●	⊙	⊙		FS unit temperature sensor (TCS) trouble	FS unit temperature sensor (TCS) has been open/short-circuited.
L12	L12	-	⊙	○	⊙		FS unit(s) system trouble	FS unit(s) outside the application setting

List of Check Codes (Outdoor Unit)

(Check code detected by outdoor interface - typical examples)

If "HELLO" is displayed on the outdoor 7-segment for 1 minute or more, turn off the power supply once and then turn on the power supply again after passage of 30 seconds or more. When the same symptom appears, it is considered there is a possibility of I/F board trouble.

○ : Lighting, ◎ : Flashing, ● : Goes off
 ALT.: Flashing is alternately when there are two flashing LED
 SIM: Simultaneous flashing when there are two flashing LED

Check code		Central control or main remote controller display	Display of receiving unit				Typical problem site	Description of problem																																																																																								
Outdoor 7-segment display	Sub-code		Indicator light block			Flash																																																																																										
			Operation ⏴	Timer ⏵	Ready ⦿																																																																																											
E06	Number of indoor units from which signal is received normally	E06	●	●	◎		Signal lack of indoor unit	Indoor unit initially communicating normally fails to return signal (reduction in number of indoor units connected).																																																																																								
E07	–	(E04)	●	●	◎		Indoor-outdoor communication circuit trouble	Signal cannot be transmitted to indoor units (→ indoor units left without communication from outdoor unit).																																																																																								
E08	Duplicated indoor address	(E08)	◎	●	●		Duplicated indoor address	More than one indoor unit are assigned same address (also detected at indoor unit end).																																																																																								
E12	01: Indoor-outdoor communication 02: Outdoor-outdoor communication	E12	◎	●	●		Automatic address starting trouble	<ul style="list-style-type: none"> Indoor automatic address setting is started while automatic address setting for equipment in other refrigerant line is in progress. Outdoor automatic address setting is started while automatic address setting for indoor units is in progress. 																																																																																								
E15	–	E15	●	●	◎		Indoor unit not found during automatic address setting	Indoor unit fails to communicate while automatic address setting for indoor units is in progress.																																																																																								
E16	00: Capacity over 01: Number of units connected	E16	●	●	◎		Too many indoor units connected/capacity over	Combined capacity of indoor units is too large. The maximum combined of indoor units shown in the specification table.																																																																																								
E19	00: No header unit 02: Two or more header units	E19	●	●	◎		Trouble in number of outdoor header units	There is no or more than one outdoor header unit in one refrigerant line.																																																																																								
E20	01: Connection of outdoor unit from other refrigerant line 02: Connection of indoor unit from other refrigerant line	E20	●	●	◎		Connection to other refrigerant line found during automatic address setting	Indoor unit from other refrigerant line is detected while indoor automatic address setting is in progress.																																																																																								
E23	–	E23	●	●	◎		Outdoor-outdoor communication transmission trouble	Signal cannot be transmitted to other outdoor units.																																																																																								
E25	–	E25	●	●	◎		Duplicated follower outdoor address	There is duplication in outdoor addresses set manually.																																																																																								
E26	Address of outdoor unit from which signal is not received normally	E26	●	●	◎		Signal lack of outdoor unit	Follower outdoor unit initially communicating normally fails to do so (reduction in number of follower outdoor units connected).																																																																																								
E28	Detected outdoor unit No.	E28	●	●	◎		Outdoor follower unit trouble	Outdoor header unit detects trouble relating to follower outdoor unit (detail displayed on follower outdoor unit).																																																																																								
E31	<table border="1"> <thead> <tr> <th colspan="4">P.C.board</th> <th colspan="4">P.C.board</th> </tr> <tr> <th colspan="2">Compressor</th> <th colspan="2">Fan Motor</th> <th colspan="2">Compressor</th> <th colspan="2">Fan Motor</th> </tr> <tr> <th>1</th><th>2</th><th>1</th><th>2</th><th>1</th><th>2</th><th>1</th><th>2</th> </tr> </thead> <tbody> <tr><td>01</td><td>○</td><td></td><td></td><td>11</td><td>○</td><td></td><td>○</td></tr> <tr><td>02</td><td></td><td>○</td><td></td><td>12</td><td></td><td>○</td><td></td></tr> <tr><td>03</td><td>○</td><td>○</td><td></td><td>13</td><td>○</td><td>○</td><td>○</td></tr> <tr><td>08</td><td></td><td></td><td>○</td><td>18</td><td></td><td></td><td>○</td></tr> <tr><td>09</td><td>○</td><td></td><td>○</td><td>19</td><td>○</td><td></td><td>○</td></tr> <tr><td>0A</td><td></td><td>○</td><td>○</td><td>1A</td><td></td><td>○</td><td>○</td></tr> <tr><td>0B</td><td>○</td><td>○</td><td>○</td><td>1B</td><td>○</td><td>○</td><td>○</td></tr> <tr><td>10</td><td></td><td></td><td>○</td><td></td><td></td><td></td><td></td></tr> </tbody> </table> <p>Circle (○): Trouble P.C. board 80 : Communication trouble between MCU and Sub MCU</p>	P.C.board				P.C.board				Compressor		Fan Motor		Compressor		Fan Motor		1	2	1	2	1	2	1	2	01	○			11	○		○	02		○		12		○		03	○	○		13	○	○	○	08			○	18			○	09	○		○	19	○		○	0A		○	○	1A		○	○	0B	○	○	○	1B	○	○	○	10			○					E31	●	●	◎		P.C. board communication trouble Sub MCU communication trouble	There is no communication between P.C. boards in inverter box.
P.C.board				P.C.board																																																																																												
Compressor		Fan Motor		Compressor		Fan Motor																																																																																										
1	2	1	2	1	2	1	2																																																																																									
01	○			11	○		○																																																																																									
02		○		12		○																																																																																										
03	○	○		13	○	○	○																																																																																									
08			○	18			○																																																																																									
09	○		○	19	○		○																																																																																									
0A		○	○	1A		○	○																																																																																									
0B	○	○	○	1B	○	○	○																																																																																									
10			○																																																																																													
F04	–	F04	◎	◎	○	ALT	Outdoor discharge temperature sensor (TD1) trouble	Outdoor discharge temperature sensor (TD1) has been open/short-circuited.																																																																																								
F05	–	F05	◎	◎	○	ALT	Outdoor discharge temperature sensor (TD2) trouble	Outdoor discharge temperature sensor (TD2) has been open/short-circuited.																																																																																								
F06	01: TE1 sensor 02: TE2 sensor 03: TE3 sensor	F06	◎	◎	○	ALT	Outdoor heat exchanger liquid side temperature sensor (TE1, TE2, TE3) trouble	Outdoor heat exchanger liquid side temperature sensors (TE1, TE2, TE3) have been open/short-circuited.																																																																																								
F07	01: TL1 sensor 02: TL2 sensor 03: TL3 sensor	F07	◎	◎	○	ALT	Outdoor liquid temperature sensor (TL1, TL2, TL3) trouble	Outdoor liquid temperature sensor (TL1, TL2, TL3) has been open/short-circuited.																																																																																								
F08	–	F08	◎	◎	○	ALT	Outdoor outside air temperature sensor (TO) trouble	Outdoor air temperature sensor (TO) has been open/short-circuited.																																																																																								
F09	01: TG1 sensor 02: TG2 sensor 03: TG3 sensor	F09	◎	◎	○	ALT	Outdoor heat exchanger gas side temperature sensor (TG1, TG2, TG3) trouble	Outdoor heat exchanger gas side temperature sensors (TG1, TG2, TG3) have been open/short-circuited.																																																																																								

Check code		Display of receiving unit				Typical problem site	Description of problem	
Outdoor 7-segment display		Central control or main remote controller display	Indicator light block					
Sub-code			Operation 	Timer 	Ready 	Flash		
F12	01: TS1 sensor 03: TS3 sensor	F12	⊙	⊙	○	ALT	Outdoor suction temperature sensor (TS1,TS3) trouble	Outdoor suction temperature sensor (TS1,TS3) has been open/short-circuited.
F15	–	F15	⊙	⊙	○	ALT	Outdoor temperature sensor (TE1,TL1) wiring trouble	Wiring trouble in outdoor temperature sensors (TE1,TL1) has been detected.
F16	–	F16	⊙	⊙	○	ALT	Outdoor pressure sensor (Pd, Ps) wiring trouble	Wiring trouble in outdoor pressure sensors (Pd, Ps) has been detected.
F23	–	F23	⊙	⊙	○	ALT	Low pressure sensor (Ps) trouble	Output voltage of low pressure sensor (Ps) is zero.
F24	–	F24	⊙	⊙	○	ALT	High pressure sensor (Pd) trouble	Output voltage of high pressure sensor (Pd) is zero or provides abnormal readings when compressors have been turned off.
F31	–	F31	⊙	⊙	○	SIM	Outdoor EEPROM trouble	Outdoor EEPROM is failure (alarm and shutdown for header unit and continued operation for follower unit)
H05	–	H05	●	⊙	●		Outdoor discharge temperature sensor (TD1) wiring trouble	Wiring/installation trouble or detachment of outdoor discharge temperature sensor (TD1) has been detected.
H06	–	H06	●	⊙	●		Activation of low-pressure protection	Low pressure (Ps) sensor detects abnormally low operating pressure.
H07	–	H07	●	⊙	●		Low oil level protection	Temperature sensor for oil level detection (TK1,TK2) detects abnormally low oil level.
H08	01: TK1 sensor trouble 02: TK2 sensor trouble	H08	●	⊙	●		Trouble in temperature sensor for oil level detection (TK1,TK2)	Temperature sensor for oil level detection (TK1,TK2) has been open/short-circuited.
H15	–	H15	●	⊙	●		Outdoor discharge temperature sensor (TD2) wiring trouble	Wiring/installation trouble or detachment of outdoor discharge temperature sensor (TD2) has been detected.
H16	01: TK1 oil circuit trouble 02: TK2 oil circuit trouble	H16	●	⊙	●		Oil level detection circuit trouble	No temperature change is detected by temperature sensor for oil level detection (TK1,TK2) despite compressor having been started.
L04	–	L04	⊙	○	⊙	SIM	Duplicated outdoor refrigerant line address	Identical refrigerant line address has been assigned to outdoor units belonging to different refrigerant piping systems.
L06	Number of priority indoor units (check code L05 or L06 depending on individual unit)	L05	⊙	●	⊙	SIM	Duplicated priority indoor unit (as displayed on priority indoor unit)	More than one indoor unit have been set up as priority indoor unit.
		L06	⊙	●	⊙	SIM	Duplicated priority indoor unit (as displayed on indoor unit other than priority indoor unit)	More than one indoor unit have been set up as priority indoor unit.
L08	–	(L08)	⊙	●	⊙	SIM	Indoor group address not set	Address setting have not been performed for one or more indoor units (also detected at indoor end).
L10	–	L10	⊙	○	⊙	SIM	Outdoor capacity not set	Outdoor unit capacity has not been set (after P.C. board replacement).
L17	–	L17	⊙	○	⊙	SIM	Outdoor model incompatibility trouble	Old model outdoor unit has been connected.
L23	–	L23	⊙	○	⊙	SIM	SW setting mistake	
L28	–	L28	⊙	○	⊙	SIM	Too many outdoor units connected	More than five outdoor units have been connected.

Check code			Display of receiving unit				Typical problem site	Description of problem																																													
Outdoor 7-segment display			Indicator light block																																																		
Sub-code	Central control or main remote controller display		Operation	Timer	Ready	Flash																																															
	Compressor	Fan Motor	⏻	⌚	⊙	⚡																																															
L29	<table border="1"> <tr><th colspan="4">P.C.board</th></tr> <tr><th colspan="2">Compressor</th><th colspan="2">Fan Motor</th></tr> <tr><th>1</th><th>2</th><th>1</th><th>2</th></tr> <tr><td>01</td><td>○</td><td></td><td></td></tr> <tr><td>02</td><td></td><td>○</td><td></td></tr> <tr><td>03</td><td>○</td><td>○</td><td></td></tr> <tr><td>08</td><td></td><td></td><td>○</td></tr> <tr><td>09</td><td>○</td><td></td><td>○</td></tr> <tr><td>0A</td><td></td><td>○</td><td>○</td></tr> <tr><td>0B</td><td>○</td><td>○</td><td>○</td></tr> <tr><td>10</td><td></td><td></td><td>○</td></tr> </table>		P.C.board				Compressor		Fan Motor		1	2	1	2	01	○			02		○		03	○	○		08			○	09	○		○	0A		○	○	0B	○	○	○	10			○	L29	⊙	○	⊙	SIM	Trouble in number of P.C. boards	There are insufficient number of P.C. board in inverter box.
	P.C.board																																																				
	Compressor		Fan Motor																																																		
	1	2	1	2																																																	
	01	○																																																			
	02		○																																																		
	03	○	○																																																		
	08			○																																																	
	09	○		○																																																	
	0A		○	○																																																	
	0B	○	○	○																																																	
10			○																																																		
<table border="1"> <tr><th colspan="4">P.C.board</th></tr> <tr><th colspan="2">Compressor</th><th colspan="2">Fan Motor</th></tr> <tr><th>1</th><th>2</th><th>1</th><th>2</th></tr> <tr><td>11</td><td>○</td><td></td><td>○</td></tr> <tr><td>12</td><td></td><td>○</td><td></td></tr> <tr><td>13</td><td>○</td><td>○</td><td></td></tr> <tr><td>18</td><td></td><td></td><td>○</td></tr> <tr><td>19</td><td>○</td><td></td><td>○</td></tr> <tr><td>1A</td><td></td><td>○</td><td>○</td></tr> <tr><td>1B</td><td>○</td><td>○</td><td>○</td></tr> </table>		P.C.board				Compressor		Fan Motor		1	2	1	2	11	○		○	12		○		13	○	○		18			○	19	○		○	1A		○	○	1B	○	○	○												
P.C.board																																																					
Compressor		Fan Motor																																																			
1	2	1	2																																																		
11	○		○																																																		
12		○																																																			
13	○	○																																																			
18			○																																																		
19	○		○																																																		
1A		○	○																																																		
1B	○	○	○																																																		
Circle (O): Trouble P.C. board																																																					
L30	Detected indoor unit No.		(L30)	⊙	○	⊙	SIM	Indoor external trouble input (interlock)	Indoor unit has been shut down for external trouble input in one refrigerant line (detected by indoor unit).																																												
P03	-		P03	⊙	●	⊙	ALT	Outdoor discharge (TD1) temperature trouble	Outdoor discharge temperature sensor (TD1) has detected abnormally high temperature.																																												
P05	00: Power detection trouble 01: Open phase 02: Power supply miswiring		P05	⊙	●	⊙	ALT	Power detection trouble /Open phase detection /Power supply miswiring detection	Open phase is detected when power is turned on. Inverter DC voltage is too high (overvoltage) or too low (undervoltage).																																												
P07	1 : Compressor 1 heat sink trouble 2 : Compressor 2 heat sink trouble		P07	⊙	●	⊙	ALT	Heat sink overheating trouble	Temperature sensor built into IPM (TH) detects overheating.																																												
	04: Heat sink dew condensation							Heat sink dew condensation trouble	Outdoor liquid temperature sensor (TL2) has detected abnormally low temperature.																																												
P10	Indoor unit No. detected		(P10)	●	⊙	⊙	ALT	Indoor unit overflow	Indoor unit has been shutdown in one refrigerant line due to detection of overflow (detected by indoor unit).																																												
P11	-		P11	●	⊙	⊙	ALT	Outdoor heat exchanger freeze trouble	Remaining frost on outdoor heat exchanger has been detected repeatedly.																																												
P13	-		P13	●	⊙	⊙	ALT	Outdoor liquid backflow detection trouble	State of refrigerant cycle circuit indicates liquid backflow operation.																																												
P15	01: TS condition 02: TD condition		P15	⊙	●	⊙	ALT	Gas leak detection	Outdoor suction temperature sensor (TS1) detects sustained and repeated high temperatures that exceed standard value.																																												
P17	-		P17	⊙	●	⊙	ALT	Outdoor discharge (TD2) temperature trouble	Outdoor discharge temperature sensor (TD2) detects abnormally high temperature.																																												
P19	Outdoor unit No. detected		P19	⊙	●	⊙	ALT	4-way valve reversing trouble	Abnormality in refrigerating cycle is detected during heating operation.																																												
P20	-		P20	⊙	●	⊙	ALT	Activation of high-pressure protection	High pressure (Pd) sensor detects high pressure that exceeds standard value.																																												

MG-CTT: Magnet contactor

(Check code detected by Inverter of Compressor featuring in outdoor unit - typical examples)

Check code		Display of receiving unit				Typical problem site	Description of proplem	
Outdoor 7-segment display		Central control or main remote controller display	Indicator light block					
Sub-code			Operation Ⓛ	Timer Ⓢ	Ready Ⓢ	Flash		
F13	1*: Compressor 1 2*: Compressor 2	F13	Ⓛ	Ⓢ	○	ALT	Trouble in temperature sensor built into indoor IPM (TH)	Temperature sensor built into indoor IPM (TH) has been open/short-circuited.
H01	1*: Compressor 1 2*: Compressor 2	H01	●	Ⓢ	●		Compressor breakdown	Inverter current (Idc) detection circuit detects overcurrent.
H02	1*: Compressor 1 2*: Compressor 2	H02	●	Ⓢ	●		Compressor trouble (lockup)	Compressor lockup is detected
H03	1*: Compressor 1 2*: Compressor 2	H03	●	Ⓢ	●		Current detection circuit trouble	Abnormal current is detected while inverter compressor is turned off.
P04	01: Compressor 1 02: Compressor 2	P04	Ⓛ	●	Ⓢ	ALT	Activation of high-pressure SW	High-pressure SW is activated.
P05	01: Compressor 1 side 02: Compressor 2 side	P05	Ⓛ	●	Ⓢ	ALT	Compressor Vdc trouble	Inverter DC voltage is too high (overvoltage) or too low (undervoltage).
P07	01: Compressor 1 side 02: Compressor 2 side	P07	Ⓛ	●	Ⓢ	ALT	Heat sink overheat trouble	Temperature sensor built into IPM (TH) detects overheating.
P11	–	P11	●	Ⓢ	Ⓢ	ALT	Outdoor heat exchanger freeze trouble	Remaining frost on outdoor heat exchanger has been detected repeatedly.
P22	1*: Fan P.C. board 1 2*: Fan P.C. board 2	P22	Ⓛ	●	Ⓢ	ALT	Outdoor fan P.C. board trouble	Outdoor fan P.C. board detects trouble.
P26	1*: Compressor 1 2*: Compressor 2	P26	Ⓛ	●	Ⓢ	ALT	Activation of IPM, compressor short-circuit protection	Short-circuit protection for compressor motor driver circuit components is activated (momentary overcurrent).
P29	1*: Compressor 1 2*: Compressor 2	P29	Ⓛ	●	Ⓢ	ALT	Compressor position detection circuit trouble	Compressor motor position detection trouble is detected.

Note: The above check codes are examples only, and different check codes may be displayed depending on the outdoor unit configuration

9-3. Troubleshooting based on information displayed on remote controller

<RBC-AMTU***>

(1) Checking and testing

When a trouble occurs to an air conditioner, a check code and indoor unit No. are displayed on the display window of the remote controller.

Check codes are only displayed while the air conditioner is in operation.

If the display has already disappeared, access check code history by following the procedure described below.

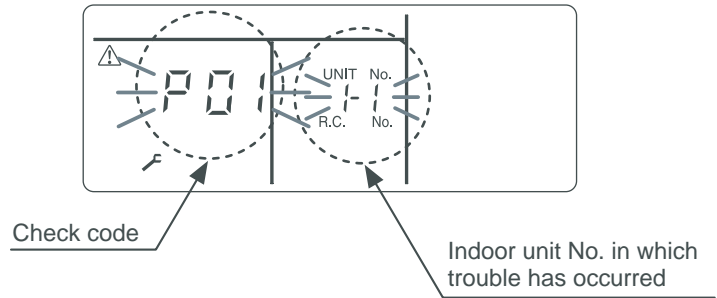

(2) Trouble history

The trouble history access procedure is described below (up to four check codes stored in memory).

Check code history can be accessed regardless of whether the air conditioner is in operation or shut down.

<Procedure> To be performed when system at rest

- 1 Invoke the **SERVICE CHECK** mode by pressing the **TEST** + **SET** buttons simultaneously and holding for at least 4 seconds.

The letters "SERVICE CHECK" light up, and the check code "01" is displayed, indicating the trouble history. This is accompanied by the indoor unit No. to which the trouble history is related and a check code.

- 2 To check other trouble history items, press the **TEMP.** button to select another check code.

Check code "01" (latest) → Check code "04" (oldest)

Note: Trouble history contains four items.

- 3 When the **TEST** button is pushed, normal display is restored.

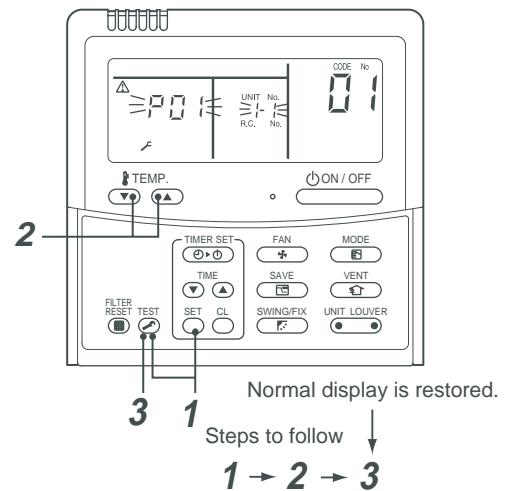

CAUTION

Do not push the **TEST** button as it would erase the whole trouble history of the indoor unit.

<RBC-ASCU11-*>

(1) Confirmation and check

If a problem occurs with the air conditioner, the OFF timer indicator alternately shows the check code and the indoor Unit No. in which the problem occurred.

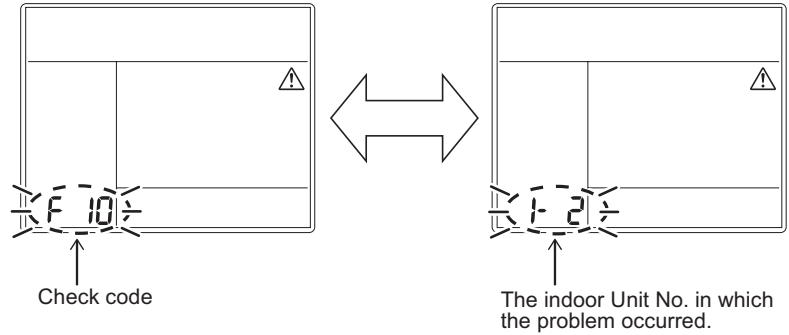

(2) Troubleshooting history and confirmation

You can check the troubleshooting history with the following procedure if a problem occurs with the air conditioner.

(The troubleshooting history records up to 4 incidents.)

You can check it during operation or when operation is stopped.

- If you check the troubleshooting history during OFF timer operation, the OFF timer will be canceled.

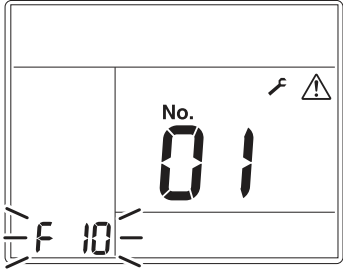
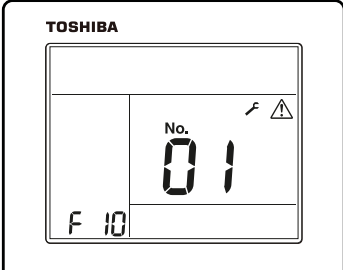
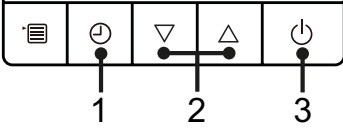
Procedure	Description of operation
<p>1</p>	<p>Push the OFF timer button for over 10 seconds and the indicators appear as an image indicating the troubleshooting history mode has been entered. If [ Service check] is displayed, the mode enters in the troubleshooting history mode.</p> <ul style="list-style-type: none"> • [01: Order of troubleshooting history] appears in the temperature indicator. • The OFF timer indicator alternately shows the [check code] and the [indoor Unit No.] in which the problem occurred. 
<p>2</p>	<p>Each time the setting button is pushed, the recorded troubleshooting history is displayed in sequence. The troubleshooting history appears in order from [01] (newest) to [04] (oldest).</p> <p>CAUTION</p> <p>In the troubleshooting history mode, DO NOT push the Menu button for over 10 seconds, doing so deletes the entire troubleshooting history of the indoor unit.</p> 
<p>3</p>	<p>After you have finished checking, push the ON/OFF button to return to the regular mode.</p> <ul style="list-style-type: none"> • If the air conditioner is operating, it remains operated even after the ON/OFF button has been pushed. To stop its operation, push the ON/OFF button again. 

How to read displayed information

<7-segment display symbols>



<Corresponding alphanumerical letters>

0 1 2 3 4 5 6 7 8 9 A b C d E F H J L P

Using indoor unit indicators (receiving unit light block) (wireless type)

To identify the check code, check the 7-segment display on the header unit. To check for check codes not displayed on the 7-segment display, consult the "List of Check Codes (Indoor Unit)" in "9-2. Troubleshooting method".

● : Goes off ○ : Lighting ☀ : Blinking (0.5 seconds)

Light block	Check code	Cause of trouble			
Operation ● Timer ● Ready ● All lights out	–	Power turned off or trouble in wiring between receiving and indoor units			
Operation ☀ Timer ● Ready ● Blinking	E01	Trouble reception	Receiving unit	Trouble or poor contact in wiring between receiving unit and indoor units	
	E02	Trouble transmission			
	E03	Loss of communication			
		E08	Duplicated indoor unit No. (address)		Setting trouble
		E09	Duplicated master remote controller		
		E10	Communication trouble between indoor unit MCU		
		E11	Communication trouble between Application control kit and indoor unit P.C. board		
		E12	Automatic address starting trouble		
		E18	Trouble or poor contact in wiring between indoor units, indoor power turned off		
Operation ● Timer ● Ready ☀ Blinking		E04	Trouble or poor contact in wiring between indoor and outdoor units (loss of indoor-outdoor communication)		
	E06	Trouble reception in indoor-outdoor communication (dropping out of indoor unit)			
	E07	Trouble transmission in indoor-outdoor communication			
	E15	Indoor unit not found during automatic address setting			
	E16	Too many indoor units connected / overloading			
	E19	Trouble in number of outdoor header units			
	E20	Detection of refrigerant piping communication trouble during automatic address setting			
	E23	Trouble transmission in outdoor-outdoor communication			
	E25	Duplicated follower outdoor address			
	E26	Trouble reception in outdoor-outdoor communication, dropping out of outdoor unit			
	E28	Outdoor follower unit trouble			
	E31	P.C. board communication trouble			
Operation ● Timer ☀ Ready ☀ Alternate blinking	P01	Indoor AC fan trouble			
	P10	Indoor overflow trouble			
	P11	Outdoor heat exchanger freezing trouble			
	P12	Indoor DC fan trouble			
	P13	Outdoor liquid backflow detection trouble			
Operation ☀ Timer ● Ready ☀ Alternate blinking	P03	Outdoor discharge (TD1) temperature trouble			
	P04	Activation of outdoor high-pressure SW			
	P05	Open phase / power failure			
		Inverter DC voltage (Vdc) trouble MG-CTT trouble			
	P07	Outdoor heat sink overheating trouble - Poor cooling of electrical component (IGBT) of outdoor unit			
	P15	Gas leak detection - insufficient refrigerant charging			
	P17	Outdoor discharge (TD2) temperature trouble			
	P18	Outdoor discharge (TD3) temperature trouble			
	P19	Outdoor 4-way valve reversing trouble			
	P20	Activation of high-pressure protection			
	P22	Outdoor fan P.C. board trouble			
	P26	Outdoor IPM, Compressor short-circuit trouble			
	P29	Compressor position detection circuit trouble			
	P31	Shutdown of other indoor unit in group due to trouble (group follower unit trouble)			

MG-CTT: Magnet contactor

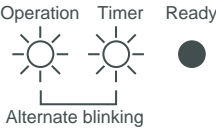
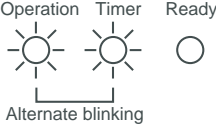
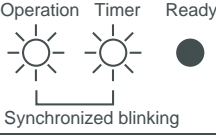
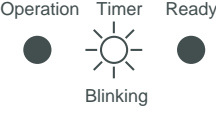
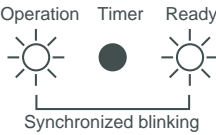
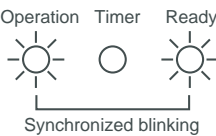
Light block	Check code	Cause of trouble		
Operation Timer Ready 	F01	Heat exchanger temperature sensor (TCJ) trouble	Indoor unit temperature sensor trouble	
	F02	Heat exchanger temperature sensor (TC2) trouble		
	F03	Heat exchanger temperature sensor (TC1) trouble		
	F10	Ambient temperature sensor (TA) trouble		
	F11	Discharge temperature sensor (TF) trouble		
Operation Timer Ready 	F04	Discharge temperature sensor (TD1) trouble	Outdoor unit temperature sensor trouble	
	F05	Discharge temperature sensor (TD2) trouble		
	F06	Heat exchanger temperature sensor (TE1, TE2) trouble		
	F07	Liquid temperature sensor (TL) trouble		
	F08	Outside air temperature sensor (TO) trouble		
	F09	TG1, TG2 or TG3 sensor trouble		
	F12	Suction temperature sensor (TS1) trouble		
	F13	Heat sink sensor (TH) trouble		
	F15	Wiring trouble in heat exchanger sensor (TE1) and liquid temperature sensor (TL) Outdoor unit temperature sensor wiring / installation trouble	Outdoor unit pressure sensor trouble	
	F16	Wiring trouble in outdoor high pressure sensor (Pd) and low pressure sensor (Ps) Outdoor pressure sensor wiring trouble		
	F22	Outdoor discharge temperature sensor (TD3) trouble		
	F23	Low pressure sensor (Ps) trouble		
	F24	High pressure sensor (Pd) trouble		
Operation Timer Ready 	F29	Failure in indoor EEPROM		
	Operation Timer Ready 	H01	Compressor breakdown	Outdoor unit compressor related trouble
H02		Compressor lockup		
H03		Current detection circuit trouble		
H04		Comp. 1 case thermostat operation	Protective shutdown of outdoor unit	
H05		Wiring / installation trouble or detachment of outdoor discharge temperature sensor (TD1)		
H06		Abnormal drop in low-pressure sensor (Ps) reading	Protective shutdown of outdoor unit	
H07		Abnormal drop in oil level		
H08		Trouble in temperature sensor for oil level detection circuit (TK1, TK2, TK3, TK4 or TK5)		
F14		Comp. 2 case thermostat operation		
H15		Wiring / installation trouble or detachment of outdoor discharge temperature sensor (TD2)		
H16		Oil level detection circuit trouble - Trouble in outdoor unit TK1, TK2, TK3, TK4 or TK5 circuit		
H25		Wiring / installation trouble or detachment of outdoor discharge temperature sensor (TD3)		
Operation Timer Ready 		L02	Model mismatched of indoor and outdoor unit	
	L03	Duplicated indoor group header unit		
	L05	Duplicated priority indoor unit (as displayed on priority indoor unit)		
	L06	Duplicated priority indoor unit (as displayed on indoor unit other than priority indoor unit)		
	L07	Connection of group control cable to a single indoor unit		
	L08	Indoor group address not set		
	L09	Indoor capacity not set		
	Operation Timer Ready 	L04	Duplicated outdoor refrigerant line address	
		L10	Outdoor capacity not set	
L17		Outdoor model incompatibility trouble		
L18		Flow selector units trouble		
L20		Duplicated central control address		
L28		Too many outdoor units connected		
L29		Trouble in number of P.C. boards		
L30		Indoor external interlock trouble (External abnormal input)		

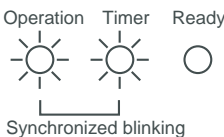
Light block	Check code	Cause of trouble
Operation Timer Ready 	F30	Occupancy sensor trouble
	F31	Outdoor EEPROM trouble

Other (indications not involving check code)

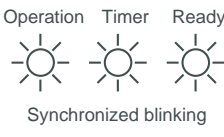
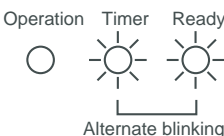
Light block	Check code	Cause of trouble
Operation Timer Ready 	–	Test run in progress
Operation Timer Ready 	–	Setting incompatibility (automatic cooling / heating setting for model incapable of it and heating setting for cooling-only model)

Flow selector unit (FS unit) Relation

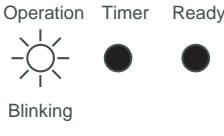
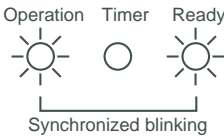
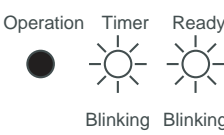
Light block	Check code	Cause of trouble
Operation Timer Ready 	E17	Communication trouble between indoor unit(s) and FS unit(s)
Operation Timer Ready 	L12	FS unit(s) system trouble
	L24	FS unit(s) setting trouble
Operation Timer Ready 	J03	Duplicated FS units
	J10	FS unit overflow trouble
	J11	FS unit temperature sensor(TCS) trouble

9-4. Check Codes Displayed on Remote Controller and SMMS series Outdoor Unit (7-Segment Display on I/F Board) and Locations to Be Checked

For other types of outdoor units, refer to their own service manuals.

Main remote controller	Check code		Location of detection	Description	System status	Check code detection condition(s)	Check items (locations)
	Outdoor 7-segment display	Sub-code					
	Check code						
E01	—	—	Remote controller	Indoor-remote controller communication trouble (detected at remote controller end)	Stop of corresponding unit	Communication between indoor P.C. board and remote controller is disrupted.	<ul style="list-style-type: none"> • Check remote controller inter-unit tie cable (A/B). • Check for broken wire or connector bad contact. • Check indoor power supply. • Check for failure in indoor P.C. board. • Check remote controller address settings (when two remote controllers are in use). • Check remote controller P.C. board.
E02	—	—	Remote controller	Remote controller transmission trouble	Stop of corresponding unit	Signal cannot be transmitted from remote controller to indoor unit.	<ul style="list-style-type: none"> • Check internal transmission circuit of remote controller. --- Replace remote controller as necessary.
E03	—	—	Indoor unit	Indoor-remote controller communication trouble (detected at indoor end)	Stop of corresponding unit	There is no communication from remote controller (including wireless) or network adaptor.	<ul style="list-style-type: none"> • Check remote controller and network adaptor wiring.
E04	—	—	Indoor unit	Indoor-outdoor communication circuit trouble (detected at indoor end)	Stop of corresponding unit	Indoor unit is not receiving signal from outdoor unit.	<ul style="list-style-type: none"> • Check order in which power was turned on for indoor and outdoor units. • Check indoor address setting. • Check indoor-outdoor tie cable. • Check outdoor terminator resistor setting (SW100, Bit 2).
E04	E06	No. of indoor units from which signal is received normally	I/F	Dropping out of indoor unit	All stop	<p>Condition 1 All indoor unit initially communicating normally fails to return signal for specified length of time.</p> <p>Condition 2 Outdoor I / F board SW103, Bit4 : OFF (Factory default)</p>	<ul style="list-style-type: none"> • Check power supply to indoor unit. (Is power turned on?) • Check connection of indoor-outdoor communication cable. • Check connection of communication connectors on indoor P.C. board. • Check connection of communication connectors on outdoor P.C. board. • Check for failure in indoor P.C. board. • Check for failure in outdoor P.C. board (I/F).
	—	—	Indoor unit	Indoor-outdoor communication circuit trouble	Only specified indoor units stop	<p>Condition 1 Indoor unit initially communicating normally fails to return signal for specified length of time.</p>	<ul style="list-style-type: none"> • Check power supply to indoor unit. (Is power turned on?) • Check indoor-outdoor power-on sequence. • Check indoor address setting • Check wiring of Indoor-outdoor communication wires • Check outdoor terminator resistor setting (SW100, Bit 2).

Main remote controller	Check code		Location of detection	Description	System status	Check code detection condition(s)	Check items (locations)
	Outdoor 7-segment display						
	Check code	Sub-code					
E04/E06	E06	No. of indoor units from which signal is received normally	Indoor unit	Indoor-outdoor communication circuit trouble (E04)	All stop	<p>Condition 1 One indoor unit or more initially communicating normally fails to return signal for specified length of time.</p> <p>Condition 2 Outdoor I / F board SW103, Bit4 : ON (To switch the check code detection condition.)</p> 	<ul style="list-style-type: none"> • Check power supply to indoor unit. (Is power turned on?) • Check indoor-outdoor power-on sequence. • Check indoor address setting • Check wiring of Indoor-outdoor communication wires • Check outdoor terminator resistor setting (SW100, Bit 2).
		I/F	Dropping out of indoor unit (E06)	<p>Display on main remote controller. Indoor units unavailable for indoor / outdoor communication. :E04 Indoor units available for indoor / outdoor communication. : E06</p>			
—	E07	—	I/F	Indoor-outdoor communication circuit trouble (detected at outdoor end)	All stop	Signal cannot be transmitted from outdoor to indoor units for 30 seconds continuously.	<ul style="list-style-type: none"> • Check outdoor terminator resistor setting (SW100, Bit 2). • Check connection of indoor-outdoor communication circuit.
E08	E08	Duplicated indoor address	Indoor unit I/F	Duplicated indoor address	All stop	More than one indoor unit are assigned same address.	<ul style="list-style-type: none"> • Check indoor addresses. • Check for any change made to remote controller connection (group/ individual) since indoor address setting.
E09	—	—	Remote controller	Duplicated master remote controller	Stop of corresponding unit	In two remote controller configuration (including wireless), both controllers are set up as master. (Header indoor unit is shut down with alarm, while follower indoor units continue operating.)	<ul style="list-style-type: none"> • Check remote controller settings. • Check remote controller P.C. boards.
E10	—	—	Indoor unit	Indoor inter-MCU communication trouble	Stop of corresponding unit	Communication cannot be established/maintained upon turning on of power or during communication.	<ul style="list-style-type: none"> • Check for failure in indoor P.C. board
E12	E12	01: Indoor-outdoor communication 02: Outdoor-outdoor communication	I/F	Automatic address starting trouble	All stop	<ul style="list-style-type: none"> • Indoor automatic address setting is started while automatic address setting for equipment in other refrigerant line is in progress. • Outdoor automatic address setting is started while automatic address setting for indoor units is in progress. 	<ul style="list-style-type: none"> • Perform automatic address setting again after disconnecting communication cable to that refrigerant line.
E15	E15	—	I/F	Indoor unit not found during automatic address setting	All stop	Indoor unit cannot be detected after indoor automatic address setting is started.	<ul style="list-style-type: none"> • Check connection of indoor-outdoor communication line. • Check for trouble in indoor power supply system. • Check for noise from other devices. • Check for power failure. • Check for failure in indoor P.C. board.

Main remote controller	Check code		Location of detection	Description	System status	Check code detection condition(s)	Check items (locations)
	Outdoor 7-segment display						
	Check code	Sub-code					
E16	E16	00: Capacity over 01:- No. of units connected	I/F	Too many indoor units connected	All stop	<ul style="list-style-type: none"> Combined capacity of indoor units is too large. <p>Note: If this code comes up after backup setting for outdoor unit failure is performed, perform "No capacity over detected" setting.</p> <p><"No capacity over detected" setting method> Turn on SW103 / Bit 3 on I/F P.C. board of outdoor header unit. For Cooling Only model, this check code is not displayed even if it exceeds the combined capacity of indoor units.</p> <ul style="list-style-type: none"> More than 128 indoor units are connected. 	<ul style="list-style-type: none"> Check capacities of indoor units connected. Check combined HP capacities of indoor units. Check HP capacity settings of outdoor units. Check No. of indoor units connected. Check for failure in outdoor P.C. board (I/F).
E18	—	—	Indoor unit	Trouble in communication between indoor header and follower units	Stop of corresponding unit	<p>Periodic communication between indoor header and follower units cannot be maintained.</p>	<ul style="list-style-type: none"> Check remote controller wiring. Check indoor power supply wiring. Check P.C. boards of indoor units.
E19	E19	00: No header unit 02: Two or more header units	I/F	Trouble in number of outdoor header units	All stop	<ul style="list-style-type: none"> There are more than one outdoor header units in one line. There is no outdoor header unit in one line. 	<p>Outdoor header unit is outdoor unit to which indoor-outdoor tie cable (U1,U2) is connected.</p> <ul style="list-style-type: none"> Check connection of indoor-outdoor communication line. Check for failure in outdoor P.C. board (I/F).
E20	E20	01: Connection of outdoor unit from other line 02: Connection of indoor unit from other line	I/F	Connection to other line found during automatic address setting	All stop	<p>Equipment from other line is found to have been connected when indoor automatic address setting is in progress.</p>	<p>Disconnect inter-line tie cable in accordance with automatic address setting method explained in "Address setting" section.</p>
E23	E23	—	I/F	Outdoor/outdoor communication transmission trouble	All stop	<p>Signal cannot be transmitted to other outdoor units for at least 30 seconds continuously.</p>	<ul style="list-style-type: none"> Check power supply to outdoor units. (Is power turned on?) Check connection of tie cables between outdoor units for bad contact or broken wire. Check communication connectors on outdoor P.C. boards. Check for failure in outdoor P.C. board (I/F). Check termination resistance setting for communication between outdoor units.
E25	E25	—	I/F	Duplicated follower outdoor address	All stop	<p>There is duplication in outdoor addresses set manually.</p>	<p>Note: Do not set outdoor addresses manually.</p>
E26	E26	Address of outdoor unit from which signal is not received normally	I/F	Signal lack of outdoor unit	All stop	<p>Outdoor unit initially communicating normally fails to return signal for specified length of time.</p>	<ul style="list-style-type: none"> Backup setting is being used for outdoor units. Check power supply to outdoor unit. (Is power turned on?) Check connection of tie cables between outdoor units for bad contact or broken wire. Check communication connectors on outdoor P.C. boards. Check for failure in outdoor P.C. board (I/F).

Check code			Location of detection	Description	System status	Check code detection condition(s)	Check items (locations)																																																																								
Main remote controller	Outdoor 7-segment display																																																																														
	Check code	Sub-code																																																																													
E28	E28	Detected outdoor unit No.	I/F	Outdoor follower unit trouble	All stop	Outdoor header unit receives trouble code from outdoor follower unit.	<ul style="list-style-type: none"> Check check code displayed on outdoor follower unit. <Convenient functions> If SW04 is pressed and held for at least 1 second while [E28] is displayed on the 7-segment display of outdoor header unit, the fan of the outdoor unit that has been shut down due to a trouble comes on. If SW04 and SW05 are pressed simultaneously, the fans of normal outdoor units come on. To stop the fan or fans, press SW05 on its own.																																																																								
E31	E31	<table border="1"> <thead> <tr> <th colspan="4">P.C. board</th> </tr> <tr> <th colspan="2">Compressor</th> <th colspan="2">Fan Motor</th> </tr> <tr> <th>1</th> <th>2</th> <th>1</th> <th>2</th> </tr> </thead> <tbody> <tr><td>01</td><td>○</td><td></td><td></td></tr> <tr><td>02</td><td></td><td>○</td><td></td></tr> <tr><td>03</td><td>○</td><td>○</td><td></td></tr> <tr><td>08</td><td></td><td></td><td>○</td></tr> <tr><td>09</td><td>○</td><td></td><td>○</td></tr> <tr><td>0A</td><td></td><td>○</td><td>○</td></tr> <tr><td>0B</td><td>○</td><td>○</td><td>○</td></tr> <tr><td>10</td><td></td><td></td><td>○</td></tr> <tr><td>11</td><td>○</td><td></td><td>○</td></tr> <tr><td>12</td><td></td><td>○</td><td>○</td></tr> <tr><td>13</td><td>○</td><td>○</td><td>○</td></tr> <tr><td>18</td><td></td><td></td><td>○</td></tr> <tr><td>19</td><td>○</td><td></td><td>○</td></tr> <tr><td>1A</td><td></td><td>○</td><td>○</td></tr> <tr><td>1B</td><td>○</td><td>○</td><td>○</td></tr> </tbody> </table> Circle (O): Trouble P.C. board	P.C. board				Compressor		Fan Motor		1	2	1	2	01	○			02		○		03	○	○		08			○	09	○		○	0A		○	○	0B	○	○	○	10			○	11	○		○	12		○	○	13	○	○	○	18			○	19	○		○	1A		○	○	1B	○	○	○	I/F	P.C. board communication trouble	All stop	Communication is disrupted between P.C. board in inverter box.	<ul style="list-style-type: none"> Check wiring and connectors involved in communication between P.C. board I/F P.C. board for bad contact or broken wire. Check for failure in outdoor P.C. board (I/F, comp. P.C. board or Fan P.C. board). Check for external noise.
		P.C. board																																																																													
Compressor		Fan Motor																																																																													
1	2	1	2																																																																												
01	○																																																																														
02		○																																																																													
03	○	○																																																																													
08			○																																																																												
09	○		○																																																																												
0A		○	○																																																																												
0B	○	○	○																																																																												
10			○																																																																												
11	○		○																																																																												
12		○	○																																																																												
13	○	○	○																																																																												
18			○																																																																												
19	○		○																																																																												
1A		○	○																																																																												
1B	○	○	○																																																																												
		80		Communication trouble between MCU and Sub MCU	All stop	Communication between MCU and Sub MCU stopped.	<ul style="list-style-type: none"> Operation of power supply reset (OFF for 60 seconds or more) Outdoor I/F PC board trouble check 																																																																								
F01	—	—	Indoor unit	Indoor TCJ sensor trouble	Stop of corresponding unit	Sensor resistance is infinity or zero (open/short circuit).	<ul style="list-style-type: none"> Check connection of TCJ sensor connector and wiring. Check resistance characteristics of TCJ sensor. Check for failure in indoor P.C. board. 																																																																								
F02	—	—	Indoor unit	Indoor TC2 sensor trouble	Stop of corresponding unit	Sensor resistance is infinity or zero (open/short circuit).	<ul style="list-style-type: none"> Check connection of TC2 sensor connector and wiring. Check resistance characteristics of TC2 sensor. Check for failure in indoor P.C. board. 																																																																								
F03	—	—	Indoor unit	Indoor TC1 sensor trouble	Stop of corresponding unit	Sensor resistance is infinity or zero (open/short circuit).	<ul style="list-style-type: none"> Check connection of TC1 sensor connector and wiring. Check resistance characteristics of TC1 sensor. Check for failure in indoor P.C. board. 																																																																								
F04	F04	—	I/F	TD1 sensor trouble	All stop	Sensor resistance is infinity or zero (open/short circuit).	<ul style="list-style-type: none"> Check connection of TD1 sensor connector. Check resistance characteristics of TD1 sensor. Check for failure in outdoor P.C. board (I/F). 																																																																								

Check code			Location of detection	Description	System status	Check code detection condition(s)	Check items (locations)
Main remote controller	Outdoor 7-segment display						
	Check code	Sub-code					
F05	F05	—	I/F	TD2 sensor trouble	All stop	Sensor resistance is infinity or zero (open/short circuit).	<ul style="list-style-type: none"> • Check connection of TD2 sensor connector. • Check resistance characteristics of TD2 sensor. • Check for failure in outdoor P.C. board (I/F).
F06	F06	01: TE1 sensor trouble 02: TE2 sensor trouble 03: TE3 sensor trouble	I/F	TE1/TE2/TE3 sensor trouble	All stop	Sensor resistance is infinity or zero (open/short circuit).	<ul style="list-style-type: none"> • Check connection of TE1/TE2/TE3 sensor connectors. • Check resistance characteristics of TE1/TE2/TE3 sensors. • Check for failure in outdoor P.C. board (I/F).
F07	F07	01: TL1 sensor trouble 02: TL2 sensor trouble 03: TL3 sensor trouble	I/F	TL1/TL2/TL3 sensor trouble	All stop	Sensor resistance is infinity or zero (open/short circuit).	<ul style="list-style-type: none"> • Check connection of TL1/TL2/TL3 sensor connector. • Check resistance characteristics of TL1/TL2/TL3 sensor. • Check for failure in outdoor P.C. board (I/F).
F08	F08	—	I/F	TO sensor trouble	All stop	Sensor resistance is infinity or zero (open/short circuit).	<ul style="list-style-type: none"> • Check connection of TO sensor connector. • Check resistance characteristics of TO sensor. • Check for failure in outdoor P.C. board (I/F).
F09	F09	01: TG1 sensor trouble 02: TG2 sensor trouble 03: TG3 sensor trouble	I/F	TG1/TG2/TG3 sensor trouble	All stop	Sensor resistance is infinity or zero (open/short circuit).	<ul style="list-style-type: none"> • Check connection of TG1/TG2/TG3 sensor connectors. • Check resistance characteristics of TG1/TG2/TG3 sensors. • Check for failure in outdoor P.C. board (I/F).
F10	—	—	Indoor unit	Indoor TA sensor trouble	Stop of corresponding unit	Sensor resistance is infinity or zero (open/short circuit).	<ul style="list-style-type: none"> • Check connection of TA sensor connector and wiring. • Check resistance characteristics of TA sensor. • Check for failure in indoor P.C. board.
F11	—	—	Indoor unit	Indoor TF sensor trouble	Stop of corresponding unit	Sensor resistance is infinity or zero (open/short circuit).	<ul style="list-style-type: none"> • Check connection of TF sensor connector and wiring. • Check resistance characteristics of TF sensor. • Check for failure in indoor P.C. board.
F12	F12	01: TS1 sensor trouble 03: TS3 sensor trouble	I/F	TS1/TS3 sensor trouble	All stop	Sensor resistance is infinity or zero (open/short circuit).	<ul style="list-style-type: none"> • Check connection of TS1/TS3 sensor connector • Check resistance characteristics of TS1/TS3 sensor. • Check for failure in indoor P.C. board.
F13	F13	1*: Compressor 1 side 2*: Compressor 2 side	Compressor P.C. board	TH sensor trouble	All stop	Sensor resistance is infinity or zero (open/short circuit).	<ul style="list-style-type: none"> • Failure in IPM built-in temperature sensor → Replace Compressor P.C. board.
F15	F15	—	I/F	Outdoor temperature sensor wiring trouble (TE1, TL1)	All stop	During compressor operation in HEAT mode, TL1 continuously provides temperature reading higher than indicated by TL1 by at least specified margin for 3 minutes or more.	<ul style="list-style-type: none"> • Check installation of TE1 and TL1 sensors. • Check resistance characteristics of TE1 and TL1 sensors. • Check for outdoor P.C. board (I/F) trouble

Main remote controller	Check code		Location of detection	Description	System status	Check code detection condition(s)	Check items (locations)
	Outdoor 7-segment display						
	Check code	Sub-code					
F16	F16	—	I/F	Outdoor pressure sensor wiring trouble (Pd, Ps)	All stop	Readings of high-pressure Pd sensor and low-pressure Ps sensor are switched. Output voltages of both sensors are zero.	<ul style="list-style-type: none"> • Check connection of high-pressure Pd sensor connector. • Check connection of low-pressure Ps sensor connector. • Check for failure in pressure sensors Pd and Ps. • Check for trouble in outdoor P.C. board (I/F). • Check for compressor poor compression.
F23	F23	—	I/F	Ps sensor trouble	All stop	Output voltage of Ps sensor is zero.	<ul style="list-style-type: none"> • Check for connection trouble involving Ps sensor and Pd sensor connectors. • Check connection of Ps sensor connector. • Check for failure in Ps sensor. • Check for compressor poor compression. • Check for failure in 4-way valve. • Check for failure in outdoor P.C. board (I/F). • Check for failure in SV4 circuit.
F24	F24	—	I/F	Pd sensor trouble	All stop	Output voltage of Pd sensor is zero (sensor open-circuited). Pd > 4.15MPa despite compressor having been turned off.	<ul style="list-style-type: none"> • Check connection of Pd sensor connector. • Check for failure in Pd sensor. • Check for failure in outdoor P.C. board (I/F).
F29	—	—	Indoor unit	Other indoor trouble	Stop of corresponding unit	Indoor P.C. board does not operate normally.	<ul style="list-style-type: none"> • Check for failure in indoor P.C. board (failure EEPROM)
F31	F31	—	I/F	Outdoor EEPROM trouble	All stop *1	Outdoor P.C. board (I/F) does not operate normally.	<ul style="list-style-type: none"> • Check power supply voltage. • Check power supply noise. • Check for failure in outdoor P.C. board (I/F).
H01	H01	1*: Compressor 1 side 2*: Compressor 2 side	Compressor P.C. board	Compressor breakdown	All stop	Inverter current detection circuit detects overcurrent and shuts system down.	<ul style="list-style-type: none"> • Check power supply voltage. (AC380V-415V ± 10%). • Check for failure in compressor. • Check for possible cause of abnormal overloading. • Check for failure in outdoor P.C. board (Compressor).
H02	H02	1*: Compressor 1 side 2*: Compressor 2 side	Compressor P.C. board	Compressor trouble (lockup) MG-CTT trouble	All stop	Overcurrent is detected several seconds after startup of inverter compressor.	<ul style="list-style-type: none"> • Check for failure in compressor. • Check power supply voltage. (AC380V-415V ± 10%). • Check compressor system wiring, particularly for open phase. • Check connection of connectors/terminals on compressor P.C. board. • Check conductivity of case heater. (Check for refrigerant problem inside compressor.) • Check for failure in outdoor P.C. board (Compressor). • Check outdoor MG-CTT.
H03	H03	1*: Compressor 1 side 2*: Compressor 2 side	Compressor P.C. board	Current detection circuit trouble	All stop	Current flow of at least specified magnitude is detected despite inverter compressor having been shut turned off.	<ul style="list-style-type: none"> • Check current detection circuit wiring. • Check failure in outdoor P.C. board (Compressor).

*1 Total shutdown in case of header unit
Continued operation in case of follower unit

Main remote controller	Check code		Location of detection	Description	System status	Check code detection condition(s)	Check items (locations)
	Outdoor 7-segment display						
	Check code	Sub-code					
H05	H05	—	I/F	TD1 sensor miswiring (incomplete insertion)	All stop	Discharge temperature of compressor 1 (TD1) does not increase despite compressor being in operation.	<ul style="list-style-type: none"> • Check installation of TD1 sensor. • Check connection of TD1 sensor connector and wiring. • Check resistance characteristics of TD1 sensor. • Check for failure in outdoor P.C. board (I/F).
H06	H06	—	I/F	Activation of low-pressure protection	All stop	Low-pressure Ps sensor detects operating pressure lower than 0.02MPa.	<ul style="list-style-type: none"> • Check service valves to confirm full opening (both gas and liquid sides). • Check outdoor PMVs for clogging (PMV1, 2, 3). • Check for failure in SV4 circuits. • Check for failure in low-pressure Ps sensor. • Check indoor filter for clogging. • Check valve opening status of indoor PMV. • Check refrigerant piping for clogging. • Check operation of outdoor fan (during heating). • Check for insufficiency in refrigerant quantity.
H07	H07	—	I/F	Low oil level protection	All stop	Operating compressor detects continuous state of low oil level for about 2 hours.	<p><All outdoor units in corresponding line to be checked></p> <ul style="list-style-type: none"> • Check connection and installation of TK1 and TK2 sensors. • Check resistance characteristics of TK1 and TK2 sensors. • Check for gas or oil leak in same line. • Check for refrigerant problem inside compressor casing. • Check SV3D, SV3F valves for failure. • Check oil return circuit of oil separator for clogging. • Check oil equalizing circuit for clogging.
H08	H08	01: TK1 sensor trouble 02: TK2 sensor trouble	I/F	Trouble in temperature sensor for oil level detection	All stop	Sensor resistance is infinity or zero (open/short circuit).	<ul style="list-style-type: none"> • Check connection of TK1 sensor connector. • Check resistance characteristics of TK1 sensor. • Check for failure in outdoor P.C. board (I/F).
					All stop	Sensor resistance is infinity or zero (open/short circuit).	<ul style="list-style-type: none"> • Check connection of TK2 sensor connector. • Check resistance characteristics of TK2 sensor. • Check for failure in outdoor P.C. board (I/F).
H15	H15	—	I/F	TD2 sensor miswiring (incomplete insertion)	All stop	Discharge temperature of (TD2) does not increase despite compressor 2 being in operation.	<ul style="list-style-type: none"> • Check installation of TD2 sensor. • Check connection of TD2 sensor connector and wiring. • Check resistance characteristics of TD2 sensor. • Check for failure in outdoor P.C. board (I/F).

Main remote controller	Check code		Location of detection	Description	System status	Check code detection condition(s)	Check items (locations)
	Outdoor 7-segment display						
	Check code	Sub-code					
H16	H16	01: TK1 oil circuit trouble 02: TK2 oil circuit trouble	I/F	Oil level detection circuit trouble	All stop	No temperature change is detected by TK1 despite compressor 1 having been started.	<ul style="list-style-type: none"> • Check for disconnection of TK1 sensor. • Check resistance characteristics of TK1 sensor. • Check for connection trouble involving TK1 and TK2 sensors • Check for clogging in oil equalizing circuit capillary. • Check for refrigerant entrapment inside compressor.
						No temperature change is detected by TK2 despite compressor 2 having been started.	<ul style="list-style-type: none"> • Check for disconnection of TK2 sensor. • Check resistance characteristics of TK2 sensor. • Check for connection trouble involving TK1 and TK2 sensors • Check SV3F valve malfunction. • Check for clogging in oil equalizing circuit capillary. • Check for refrigerant entrapment inside compressor.
H17	H17	1*: Compressor 1 side 2*: Compressor 2 side	Compressor P.C. board	Compressor trouble (Step-out)	All stop	Judged that the synchronization could not be taken.	<ul style="list-style-type: none"> • Check power supply voltage. (AC380V-415V ± 10%). • Check for failure in compressor. • Check for possible cause of abnormal overloading. • Check for failure in outdoor P.C. board (compressor).
L02	L02	—	Indoor unit	Outdoor units model disagreement trouble	Stop of corresponding unit	In case of different outdoor unit (Not corresponded to Air to Air Heat Exchanger type)	<ul style="list-style-type: none"> • Check outdoor unit model. (Check whether the outdoor unit corresponds to Air to Air Heat Exchanger type or not.)
L03	—	—	Indoor unit	Duplicated indoor header unit	Stop of corresponding unit	There are more than one header units in group.	<ul style="list-style-type: none"> • Check indoor addresses. • Check for any change made to remote controller connection (group/ individual) since indoor address setting.
L04	L04	—	I/F	Duplicated outdoor line address	All stop	There is duplication in line address setting for outdoor units belonging to different refrigerant piping systems.	<ul style="list-style-type: none"> • Check line addresses.
L05	—	—	I/F	Duplicated priority indoor unit (as displayed on priority indoor unit)	All stop	More than one indoor units have been set up as priority indoor unit.	<ul style="list-style-type: none"> • Check display on priority indoor unit.
L06	L06	No. of priority indoor units	I/F	Duplicated priority indoor unit (as displayed on indoor unit other than priority indoor unit)	All stop	More than one indoor units have been set up as priority indoor unit.	<ul style="list-style-type: none"> • Check displays on priority indoor unit and outdoor unit.
L07	—	—	Indoor unit	Connection of group control cable to standalone indoor unit	Stop of corresponding unit	There is at least one standalone indoor unit to which group control cable is connected.	<ul style="list-style-type: none"> • Check indoor addresses.
L08	L08	—	Indoor unit	Indoor group / addresses not set	Stop of corresponding unit	Address setting has not been performed for indoor units.	<ul style="list-style-type: none"> • Check indoor addresses. <p>Note: This code is displayed when power is turned on for the first time after installation.</p>
L09	—	—	Indoor unit	Indoor capacity not set	Stop of corresponding unit	Capacity setting has not been performed for indoor unit.	Set indoor capacity. (DN = 11)

Check code			Location of detection	Description	System status	Check code detection condition(s)	Check items (locations)																																																																								
Main remote controller	Outdoor 7-segment display																																																																														
	Check code	Sub-code																																																																													
L10	L10	—	I/F	Outdoor capacity not set	All stop	Initial setting of I/F P.C. board has not been implemented.	• Check model setting of P.C. board for servicing outdoor I/F P.C. board.																																																																								
L20	—	—	Network adaptor Indoor unit	Duplicated central control address	All stop	There is duplication in central control address setting.	• Check central control addresses.																																																																								
L23	—	—	I/F	SW setting mistake	All stop	Outdoor P.C. board (I/F) does not operate normally.	• Check switch setting of outdoor P.C. board (I/F).																																																																								
L28	L28	—	I/F	Too many outdoor units connected	All stop	There are more than 5 outdoor units.	• Check No. of outdoor units connected (Only up to 5 units per system allowed). • Check communication lines between outdoor units. • Check for failure in outdoor P.C. board (I/F).																																																																								
L29	L29	<table border="1"> <thead> <tr> <th colspan="4">P.C. board</th> </tr> <tr> <th colspan="2">Compressor</th> <th colspan="2">Fan Motor</th> </tr> <tr> <th>1</th> <th>2</th> <th>1</th> <th>2</th> </tr> </thead> <tbody> <tr><td>01</td><td>○</td><td></td><td></td></tr> <tr><td>02</td><td></td><td>○</td><td></td></tr> <tr><td>03</td><td>○</td><td>○</td><td></td></tr> <tr><td>08</td><td></td><td></td><td>○</td></tr> <tr><td>09</td><td>○</td><td></td><td>○</td></tr> <tr><td>0A</td><td></td><td>○</td><td>○</td></tr> <tr><td>0B</td><td>○</td><td>○</td><td>○</td></tr> <tr><td>10</td><td></td><td></td><td>○</td></tr> <tr><td>11</td><td>○</td><td></td><td>○</td></tr> <tr><td>12</td><td></td><td>○</td><td>○</td></tr> <tr><td>13</td><td>○</td><td>○</td><td>○</td></tr> <tr><td>18</td><td></td><td></td><td>○</td></tr> <tr><td>19</td><td>○</td><td></td><td>○</td></tr> <tr><td>1A</td><td></td><td>○</td><td>○</td></tr> <tr><td>1B</td><td>○</td><td>○</td><td>○</td></tr> </tbody> </table> <p>Circle (○): Trouble P.C. board</p>	P.C. board				Compressor		Fan Motor		1	2	1	2	01	○			02		○		03	○	○		08			○	09	○		○	0A		○	○	0B	○	○	○	10			○	11	○		○	12		○	○	13	○	○	○	18			○	19	○		○	1A		○	○	1B	○	○	○	I/F	Trouble in No. of P.C. board	All stop	Insufficient number of P.C. board are detected when power is turned on.	• Check model setting of P.C. board for servicing outdoor I/F P.C. board. • Check connection of UART communication connector. • Check compressor P.C. board, fan P.C. board, and I/F P.C. board for failure.
P.C. board																																																																															
Compressor		Fan Motor																																																																													
1	2	1	2																																																																												
01	○																																																																														
02		○																																																																													
03	○	○																																																																													
08			○																																																																												
09	○		○																																																																												
0A		○	○																																																																												
0B	○	○	○																																																																												
10			○																																																																												
11	○		○																																																																												
12		○	○																																																																												
13	○	○	○																																																																												
18			○																																																																												
19	○		○																																																																												
1A		○	○																																																																												
1B	○	○	○																																																																												
L30	L30	Detected indoor address	Indoor unit	Indoor external interlock (External abnormal input)	Stop of corresponding unit	• Indoor unit has been shut down due to external abnormal input signal.	When external device is connected: 1) Check for trouble in external device. 2) Check for trouble in indoor P.C. board. When external device is not connected: 1) Check for trouble in indoor P.C. board.																																																																								
—	L31	—	I/F	Extended IC trouble	Continued operation	There is part failure in P.C. board (I/F).	Check outdoor P.C. board (I/F).																																																																								
P01	—	—	Indoor unit	Indoor fan motor trouble	Stop of corresponding unit		• Check the lock of fan motor (AC fan). • Check wiring.																																																																								
P03	P03	—	I/F	Discharge temperature TD1 trouble	All stop	Discharge temperature (TD1) exceeds 115 °C.	• Check outdoor service valves (gas side, liquid side) to confirm full opening. • Check outdoor PMVs (PMV1, 2, 3, 4) for clogging. • Check resistance characteristics of TD1 sensor. • Check for insufficiency in refrigerant quantity. • Check for failure in 4-way valve. • Check for leakage of SV4 circuit. • Check SV4 circuit (wiring or installation trouble in SV41 or SV42).																																																																								

Main remote controller	Check code		Location of detection	Description	System status	Check code detection condition(s)	Check items (locations)
	Outdoor 7-segment display						
	Check code	Sub-code					
P04	P04	1*: Compressor 1 side 2*: Compressor 2 side	I/F	Activation of high-pressure SW	All stop	High-pressure SW is activated.	<ul style="list-style-type: none"> • Check connection of high-pressure SW connector. • Check for failure in Pd pressure sensor. • Check outdoor service valves (gas side, liquid side) to confirm full opening. • Check for failure in outdoor fan. • Check for failure in outdoor fan motor. • Check outdoor PMVs (PMV1, 2, 3) for clogging. • Check indoor/outdoor heat exchangers for clogging. • Check for short-circuiting of outdoor suction/discharge air flows. • Check for failure in outdoor P.C. board (I/F). • Check for trouble in indoor fan system (possible cause of air flow reduction). • Check opening status of indoor PMV. • Check indoor-outdoor communication line for wiring trouble. • Check for failure operation of check valve in discharge pipe convergent section. • Check gas balancing SV4 valve circuit. • Check for refrigerant overcharging.
P05	P05	00: Power detection trouble 01: Open phase 02: Power supply miswiring	I/F	Power detection trouble / Open phase detection / Power supply miswiring	All stop	<ul style="list-style-type: none"> • Open phase is detected when power is turned on. • Inverter DC voltage is too high (overvoltage) or too low (undervoltage). 	<ul style="list-style-type: none"> • Check for failure in outdoor P.C. board (I/F). • Check wiring of outdoor power supply. • Check power supply voltage.
		1*: Compressor 1 side 2*: Compressor 2 side	Compressor P.C. board	Compressor Vdc trouble			
P07	P07	1*: Compressor 1 side 2*: Compressor 2 side	Compressor P.C. board	Heat sink overheating trouble	All stop	Temperature sensor built into IPM (TH) is overheated.	<ul style="list-style-type: none"> • Check outdoor fan system trouble. • Check IPM and heat sink for thermal performance for failure installation. (e.g. mounting screws and thermal conductivity) • Check for failure in Compressor P.C. board. (failure IPM built-in temperature sensor (TH))
		01: Compressor 1 heat sink trouble 02: Compressor 2 heat sink trouble 04: Heat sink dew condensation	I/F	Heat sink overheating trouble Heat sink dew condensation trouble	All stop	Condensation detection on heat sink has occurred four times or more in operation. Temperature sensor built into IPM (TH) is overheated.	<ul style="list-style-type: none"> • Check outdoor fan system trouble. • Check IPM and heat sink for thermal performance for troubled installation. (e. g. mounting screws and thermal conductivity) • Check for failure in compressor P.C. board. (failure IPM built-in temperature sensor (TH)) • Check shortage of refrigerant. • Check outdoor service valves. • Check connection of TL2 sensor. • Check resistance characteristics of TL2 sensor. • Check resistance characteristics of TO sensor. • Check malfunctions of Pd and Ps sensors. • Check outdoor I/F P.C. board malfunction. • Check PMV2 and PMV3

Main remote controller	Check code		Location of detection	Description	System status	Check code detection condition(s)	Check items (locations)
	Outdoor 7-segment display						
	Check code	Sub-code					
P10	P10	Detected indoor address	Indoor unit	Indoor overflow trouble	All stop	<ul style="list-style-type: none"> • Float switch operates. • Float switch circuit is open-circuited or disconnected at connector. 	<ul style="list-style-type: none"> • Check float switch connector. • Check operation of drain pump. • Check drain pump circuit. • Check drain pipe for clogging. • Check for failure in indoor P.C. board.
P11	—	—	I/F	Outdoor heat exchanger freeze trouble	All stop	<ul style="list-style-type: none"> • Outdoor heat exchanger remaining frost detection has occurred eight times or more due to abnormal frost formation in heating operation. 	<ul style="list-style-type: none"> • Check shortage of refrigerant. • Check connection of TE1, TE2 and TE3 sensors. • Check resistance characteristics of TE1, TE2, and TE3 sensors. • Check disconnection of TS1 sensor. • Check resistance characteristics of TS1 sensor. • Check outdoor I/F P.C. board malfunction. • Check operation of 4 way valve. • Check operation of outdoor PMV (1, 2, 3). • Check short circuit from outlet air to inlet air.
P12	—	—	Indoor unit	Indoor fan motor trouble	Stop of corresponding unit	<ul style="list-style-type: none"> • Motor speed measurements continuously deviate from target value. • Overcurrent protection is activated. 	<ul style="list-style-type: none"> • Check connection of fan connector and wiring. • Check for failure in fan motor. • Check for failure in indoor P.C. board. • Check impact of outside air treatment (OA).
P13	P13	—	I/F	Outdoor liquid backflow detection trouble	All stop	<p><During cooling operation> When system is in cooling operation, high pressure is detected in the unit that has been turned off.</p> <p><During heating operation> When system is in heating operation, low pressure is detected to be high in unit that has been turned off.</p>	<ul style="list-style-type: none"> • Check full-close operation of outdoor PMV (1, 2, 3, 4). • Check for failure in Pd or Ps sensor. • Check failure in outdoor P.C. board (I/F). • Check capillary of oil separator oil return circuit for clogging. • Check for leakage of check valve in discharge pipe
P15	P15	01: TS condition	I/F	Gas leak detection (TS1 condition)	All stop	Protective shutdown due to sustained suction temperature at or above judgment criterion for at least 10 minutes is repeated four times or more. <TS trouble judgment criterion> In cooling operation: 60 °C In heating operation: 40 °C	<ul style="list-style-type: none"> • Check for insufficiency in refrigerant quantity. • Check outdoor service valves (gas side, liquid side) to confirm full opening. • Check PMVs (PMV1, 2, 3, 4) for clogging. • Check resistance characteristics of TS1 sensor. • Check for failure in 4-way valve. • Check SV4 circuit for leakage
		02: TD condition	I/F	Gas leak detection (TD condition)	All stop	Protective shutdown due to sustained discharge temperature (TD1 or TD2) at or above 108 °C for at least 10 minutes is repeated four times or more.	<ul style="list-style-type: none"> • Check for insufficiency in refrigerant quantity. • Check PMVs (PMV 1, 2, 3, 4) for clogging. • Check resistance characteristics of TD1 and TD2 sensors. • Check indoor filter for clogging. • Check piping for clogging. • Check SV4 circuit (for leakage or coil installation trouble).

Main remote controller	Check code		Location of detection	Description	System status	Check code detection condition(s)	Check items (locations)
	Outdoor 7-segment display						
	Check code	Sub-code					
P17	P17	—	I/F	Discharge temperature TD2 trouble	All stop	Discharge temperature (TD2) exceeds 115 °C.	<ul style="list-style-type: none"> • Check outdoor service valves (gas side, liquid side) to confirm full opening. • Check outdoor PMVs (PMV1, 2, 3, 4) for clogging. • Check resistance characteristics of TD2 sensor. • Check for failure in 4-way valve. • Check SV4 circuit for leakage. • Check SV4 circuit (for wiring or installation trouble involving SV41 and SV42).
P19	P19	Detected outdoor unit No.	I/F	4-way valve reversing trouble	All stop	Abnormal refrigerating cycle data is collected during heating operation.	<ul style="list-style-type: none"> • Check for failure in main body of 4-way valve. • Check for coil failure in 4-way valve and loose connection of its connector. • Check resistance characteristics of TS1 and TE1, TE2 sensors. • Check output voltage characteristics of Pd and Ps pressure sensors. • Check for wiring trouble involving TE1 and TL1 sensors.
P20	P20	—	I/F	Activation of high-pressure protection	All stop	<p><During cooling operation> Pd sensor detects pressure equal to or greater than 3.85 MPa.</p> <p><During heating operation> Pd sensor detects pressure equal to or greater than 3.6 MPa.</p>	<ul style="list-style-type: none"> • Check for failure in Pd pressure sensor. • Check service valves (gas side, liquid side) to confirm full opening. • Check for failure in outdoor fan. • Check for failure in outdoor fan motor. • Check outdoor PMV (PMV1, 2, 3, 4) for clogging. • Check indoor/outdoor heat exchangers for clogging. • Check for short-circuiting of outdoor suction/discharge air flows. • Check for failure in outdoor P.C. board (I/F). • Check for failure in indoor fan system (possible cause of air flow reduction). • Check opening status of indoor PMV. • Check indoor-outdoor communication line for wiring trouble. • Check for trouble operation of check valve in discharge pipe convergent section. • Check gas balancing SV4 valve circuit. • Check for refrigerant overcharging.

Check code			Location of detection	Description	System status	Check code detection condition(s)	Check items (locations)
Main remote controller	Outdoor 7-segment display						
	Check code	Sub-code					
P22	P22	1*: Fan P.C. board 1 2*: Fan P.C. board 2	Fan INV. P.C. board	Outdoor fan P.C. board trouble	All stop	Protected operation of Fan inverter P.C. board	<ul style="list-style-type: none"> • Check fan motor. • Check for failure in fan P.C. board. • Check connection of fan motor connector. • Check power voltage of the main power supply.
P26	P26	1*: Compressor 1 side 2*: Compressor 2 side	Compressor P.C. board	IPM, Compressor shortcircuit protection trouble	All stop	Overcurrent is momentarily detected during startup of compressor.	<ul style="list-style-type: none"> • Check connector connection and wiring on compressor P.C. board. • Check for failure in compressor (layer shortcircuit). • Check for failure in outdoor P.C. board (Compressor).
P29	P29	1*: Compressor 1 side 2*: Compressor 2 side	Compressor P.C. board	Compressor position detection circuit trouble	All stop	Position detection is not going on normally.	<ul style="list-style-type: none"> • Check wiring and connector connection. • Check for compressor layer short-circuit. • Check for failure in compressor P.C. board.
P31	—	—	Indoor unit	Other indoor trouble (group follower unit trouble)	Stop of corresponding unit	There is trouble in other indoor unit in group, resulting in detection of E07/L07/L03/L08.	<ul style="list-style-type: none"> • Check indoor P.C. board.

Check codes Detected by Central Control Device

Main remote controller	Check code		Location of detection	Description	System status	Check code detection condition(s)	Check items (locations)
	Outdoor 7-segment display	Sub-code					
C05	—		Central control device	Central control device transmission trouble	Continued operation	Central control device is unable to transmit signal.	<ul style="list-style-type: none"> • Check for failure in central control device. • Check for failure in central control communication line. • Check termination resistance setting.
C06	—		Central control device	Central control device reception trouble	Continued operation	Central control device is unable to receive signal.	<ul style="list-style-type: none"> • Check for failure in central control device. • Check for failure in central control communication line. • Check terminator resistor setting. • Check power supply for devices at other end of central control communication line. • Check failure in P.C. boards of devices at other end of central control communication line.
C12	—		General-purpose device I/F	Batch alarm for general-purpose device control interface	Continued operation	Trouble signal is input to control interface for general-purpose devices.	<ul style="list-style-type: none"> • Check trouble input.
P30	Differs according to nature of alarm-causing trouble		Central control device	Group control follower unit trouble	Continued operation	Trouble occurs in follower unit under group control. ([P30] is displayed on central control remote controller.)	<ul style="list-style-type: none"> • Check check code of unit that has generated alarm.
	(L20 displayed.)			Duplicated central control address	Continued operation	There is duplication in central control addresses.	<ul style="list-style-type: none"> • Check address settings.

◆ In case of wireless remote controller

REQUIREMENT

1. For the operation procedure, be sure to follow the matter.
2. Finish the forced cooling operation in a short time because it applies excessive strength to the air conditioner.
3. A test operation of forced heating is unavailable. Perform a test operation by heating operation using the switches of the remote controller.

However heating operation may be not carried out according to the temperature conditions.

• Check wiring/piping of indoor and outdoor units

1. Open the front panel.
2. When pushing [RESET] button for 10 seconds or more, "Pi!" sound is heard and the operation changes to a forced cooling operation. After approx. 3 minutes, a cooling operation starts forcedly. Check cool air starts blowing. If the operation does not start, check wiring again.
3. To stop a test operation, push [RESET] button once again (Approx. 1 second).
The up/down air flow adjusting plate closes and the operation stops.

• Check transmission of remote controller

1. Push "START/STOP" button of the remote controller to check an operation can also start by the remote controller.
 - When pushing [RESET] button once (For 1 second), the operation changes to automatic operation. For a forced cooling operation, keep the [RESET] button pushed over 10 seconds.
 - "Cooling" operation by the remote controller may be unavailable according to the temperature conditions. Check wiring/piping of the indoor and outdoor units in forced cooling operation.

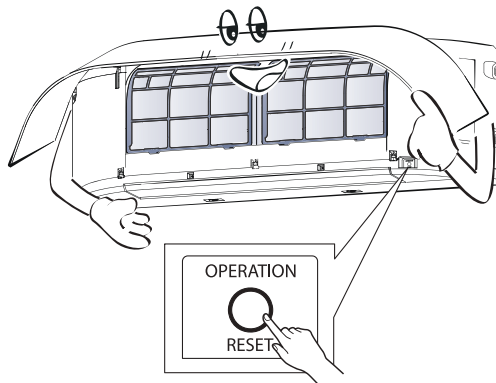

9-5. Sensor Characteristics

Indoor Unit

■ Temperature sensor characteristics

Indoor TA sensor

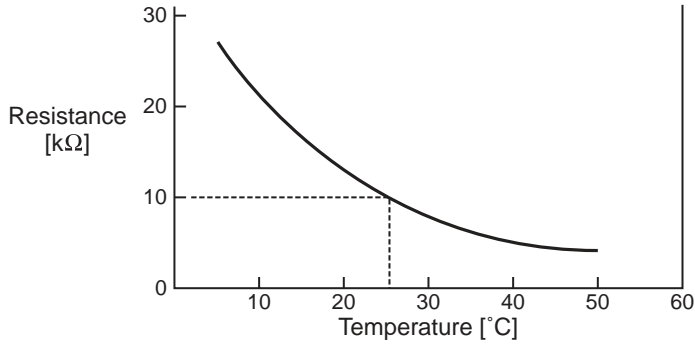

Temperature [°C]	Resistance value [kΩ]
0	33.9
5	26.1
10	20.3
15	15.9
20	12.6
25	10.0
30	8.0
35	6.4
40	5.2
45	4.2
50	3.5
55	2.8
60	2.4

Indoor TC1 sensor

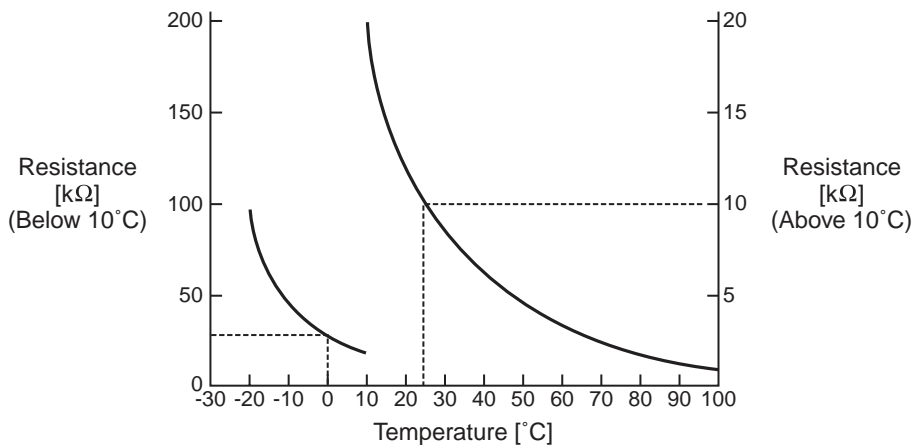

Temperature [°C]	Resistance value [kΩ]
-20	99.9
-15	74.1
-10	55.6
-5	42.2
0	32.8
5	25.4
10	19.8
15	15.6
20	12.4
25	10.0
30	8.1
35	6.5
40	5.3
45	4.4
50	3.6
55	3.0
60	2.5
65	2.1
70	1.8
75	1.5
80	1.3
85	1.1
90	1.0
95	0.8
100	0.7

Indoor TC2,TCJ sensor

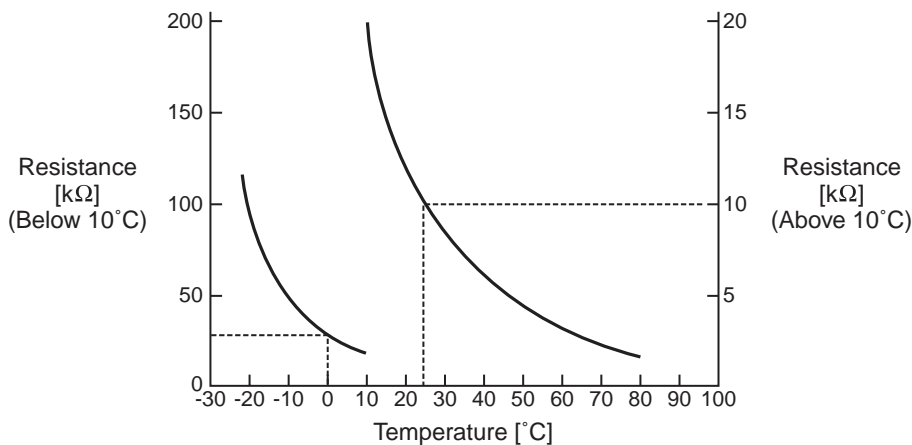

Temperature [°C]	Resistance value [kΩ]
-20	115.2
-15	84.2
-10	62.3
-5	46.6
0	35.2
5	26.9
10	20.7
15	16.1
20	12.6
25	10.0
30	8.0
35	6.4
40	5.2
45	4.2
50	3.5
55	2.8
60	2.4
65	2.0
70	1.6
75	1.4
80	1.2

10. INSTALLATION MANUAL

Original instruction

Please read this Installation Manual carefully before installing the Air Conditioner.

- This Manual describes the installation method of the indoor unit.
- For installation of the outdoor unit, follow the Installation Manual attached to the outdoor unit.

ADOPTION OF R32 or R410A REFRIGERANT

This Air Conditioner has adopted a refrigerant HFC (R32 or R410A) which does not destroy the ozone layer.

Be sure to check the refrigerant type for outdoor unit to be combined, and then install it.

Information

If U series models (TU2C-Link) are combined with models other than U series (TCC-Link), the wiring specifications and maximum number of connectable indoor units will be changed. Pay attentions to their communication specifications when carrying out the installation, maintenance, or repair. For its details, refer to the "Electrical connection" in this Manual.

Product information of ecodesign requirements. (Regulation (EU) 2016/2281)

<http://ecodesign.toshiba-airconditioning.eu/en>

Contents

1	PRECAUTIONS FOR SAFETY	94
2	ACCESSORY PARTS	100
3	SELECTION OF INSTALLATION PLACE	102
4	INSTALLATION OF INDOOR UNIT	105
5	CUTTING A HOLE AND MOUNTING INSTALLATION PLATE.....	106
6	PIPING AND DRAIN HOSE INSTALLATION.....	108
7	INDOOR UNIT FIXING.....	112
8	DRAINAGE	113
9	REFRIGERANT PIPING	114
10	ELECTRICAL CONNECTION	116
11	APPLICABLE CONTROLS.....	125
12	TEST RUN	128
13	TROUBLESHOOTING.....	130
14	SPECIFICATIONS.....	136
15	NOTICE CODE	136
16	APPENDIX	139

Thank you for purchasing this Toshiba air conditioner.

Please read carefully through these instructions that contain important information which complies with the Machinery Directive (Directive 2006/42/EC), and ensure that you understand them.

After completing the installation work, hand over this Installation Manual as well as the Owner's Manual provided to the user, and ask the user to keep them in a safe place for future reference.

Generic Denomination: Air Conditioner

Definition of Qualified Installer or Qualified Service Person

The air conditioner must be installed, maintained, repaired and removed by a qualified installer or qualified service person. When any of these jobs is to be done, ask a qualified installer or qualified service person to do them for you.

A qualified installer or qualified service person is an agent who has the qualifications and knowledge described in the table below.

Agent	Qualifications and knowledge which the agent must have
Qualified installer (*1)	<ul style="list-style-type: none"> • The qualified installer is a person who installs, maintains, relocates and removes the air conditioners made by Toshiba Carrier Corporation. He or she has been trained to install, maintain, relocate and remove the air conditioners made by Toshiba Carrier Corporation or, alternatively, he or she has been instructed in such operations by an individual or individuals who have been trained and is thus thoroughly acquainted with the knowledge related to these operations. • The qualified installer who is allowed to do the electrical work involved in installation, relocation and removal has the qualifications pertaining to this electrical work as stipulated by the local laws and regulations, and he or she is a person who has been trained in matters relating to electrical work on the air conditioners made by Toshiba Carrier Corporation or, alternatively, he or she has been instructed in such matters by an individual or individuals who have been trained and is thus thoroughly acquainted with the knowledge related to this work. • The qualified installer who is allowed to do the refrigerant handling and piping work involved in installation, relocation and removal has the qualifications pertaining to this refrigerant handling and piping work as stipulated by the local laws and regulations, and he or she is a person who has been trained in matters relating to refrigerant handling and piping work on the air conditioners made by Toshiba Carrier Corporation or, alternatively, he or she has been instructed in such matters by an individual or individuals who have been trained and is thus thoroughly acquainted with the knowledge related to this work. • The qualified installer who is allowed to work at heights has been trained in matters relating to working at heights with the air conditioners made by Toshiba Carrier Corporation or, alternatively, he or she has been instructed in such matters by an individual or individuals who have been trained and is thus thoroughly acquainted with the knowledge related to this work.
Qualified service person (*1)	<ul style="list-style-type: none"> • The qualified service person is a person who installs, repairs, maintains, relocates and removes the air conditioners made by Toshiba Carrier Corporation. He or she has been trained to install, repair, maintain, relocate and remove the air conditioners made by Toshiba Carrier Corporation or, alternatively, he or she has been instructed in such operations by an individual or individuals who have been trained and is thus thoroughly acquainted with the knowledge related to these operations. • The qualified service person who is allowed to do the electrical work involved in installation, repair, relocation and removal has the qualifications pertaining to this electrical work as stipulated by the local laws and regulations, and he or she is a person who has been trained in matters relating to electrical work on the air conditioners made by Toshiba Carrier Corporation or, alternatively, he or she has been instructed in such matters by an individual or individuals who have been trained and is thus thoroughly acquainted with the knowledge related to this work. • The qualified service person who is allowed to do the refrigerant handling and piping work involved in installation, repair, relocation and removal has the qualifications pertaining to this refrigerant handling and piping work as stipulated by the local laws and regulations, and he or she is a person who has been trained in matters relating to refrigerant handling and piping work on the air conditioners made by Toshiba Carrier Corporation or, alternatively, he or she has been instructed in such matters by an individual or individuals who have been trained and is thus thoroughly acquainted with the knowledge related to this work. • The qualified service person who is allowed to work at heights has been trained in matters relating to working at heights with the air conditioners made by Toshiba Carrier Corporation or, alternatively, he or she has been instructed in such matters by an individual or individuals who have been trained and is thus thoroughly acquainted with the knowledge related to this work.

Definition of Protective Gear



When the air conditioner is to be transported, installed, maintained, repaired or removed, wear protective gloves and 'Safety' work clothing.

In addition to such normal protective gear, wear the protective gear described below when undertaking the special work detailed in the table below.

Failure to wear the proper protective gear is dangerous because you will be more susceptible to injury, burns, electric shocks and other injuries.





Work undertaken	Protective gear worn
All types of work	Protective gloves 'Safety' working clothing
Electrical-related work	Gloves to provide protection for electricians and from heat Insulating shoes Clothing to provide protection from electric shock
Work done at heights (50 cm or more)	Helmets for use in industry
Transportation of heavy objects	Shoes with additional protective toe cap
Repair of outdoor unit	Gloves to provide protection for electricians and from heat

These safety cautions describe important matters concerning safety to prevent injury to users or other people and damages to property. Please read through this manual after understanding the contents below (meanings of indications), and be sure to follow the description.





Indication	Meaning of Indication
 WARNING	Text set off in this manner indicates that failure to adhere to the directions in the warning could result in serious bodily harm (*1) or loss of life if the product is handled improperly.
 CAUTION	Text set off in this manner indicates that failure to adhere to the directions in the caution could result in slight injury (*2) or damage (*3) to property if the product is handled improperly.

- *1: Serious bodily harm indicates loss of eyesight, injury, burns, electric shock, bone fracture, poisoning, and other injuries which leave aftereffect and require hospitalization or long-term treatment as an outpatient.
- *2: Slight injury indicates injury, burns, electric shock, and other injuries which do not require hospitalization or long-term treatment as an outpatient.
- *3: Damage to property indicates damage extending to buildings, household effects, domestic livestock, and pets.

MEANINGS OF SYMBOLS DISPLAYED ON THE UNIT

	WARNING (Risk of fire)	This mark is for R32 refrigerant only. In case that refrigerant type is R32, this unit uses a flammable refrigerant. If refrigerant leaks and comes in contact with fire or heating part, it will create harmful gas and there is risk of fire.
		Read the OWNER'S MANUAL carefully before operation.
		Service personnel are required to carefully read the OWNER'S MANUAL and INSTALLATION MANUAL before operation.
		Further information is available in the OWNER'S MANUAL, INSTALLATION MANUAL, and the like.

■ Warning indications on the air conditioner unit

Warning indication	Description						
 <table border="1" data-bbox="340 363 592 520"> <tr> <td colspan="2" style="text-align: center;">WARNING</td> </tr> <tr> <td colspan="2">ELECTRICAL SHOCK HAZARD</td> </tr> <tr> <td colspan="2">Disconnect all remote electric power supplies before servicing.</td> </tr> </table>	WARNING		ELECTRICAL SHOCK HAZARD		Disconnect all remote electric power supplies before servicing.		<p>WARNING</p> <p>ELECTRICAL SHOCK HAZARD Disconnect all remote electric power supplies before servicing.</p>
WARNING							
ELECTRICAL SHOCK HAZARD							
Disconnect all remote electric power supplies before servicing.							
 <table border="1" data-bbox="340 588 592 745"> <tr> <td colspan="2" style="text-align: center;">WARNING</td> </tr> <tr> <td colspan="2">Moving parts. Do not operate unit with grille removed. Stop the unit before the servicing.</td> </tr> </table>	WARNING		Moving parts. Do not operate unit with grille removed. Stop the unit before the servicing.		<p>WARNING</p> <p>Moving parts. Do not operate unit with grille removed. Stop the unit before the servicing.</p>		
WARNING							
Moving parts. Do not operate unit with grille removed. Stop the unit before the servicing.							
 <table border="1" data-bbox="340 810 592 968"> <tr> <td colspan="2" style="text-align: center;">CAUTION</td> </tr> <tr> <td colspan="2">High temperature parts. You might get burned when removing this panel.</td> </tr> </table>	CAUTION		High temperature parts. You might get burned when removing this panel.		<p>CAUTION</p> <p>High temperature parts. You might get burned when removing this panel.</p>		
CAUTION							
High temperature parts. You might get burned when removing this panel.							
 <table border="1" data-bbox="340 1033 592 1190"> <tr> <td colspan="2" style="text-align: center;">CAUTION</td> </tr> <tr> <td colspan="2">Do not touch the aluminum fins of the unit. Doing so may result in injury.</td> </tr> </table>	CAUTION		Do not touch the aluminum fins of the unit. Doing so may result in injury.		<p>CAUTION</p> <p>Do not touch the aluminium fins of the unit. Doing so may result in injury.</p>		
CAUTION							
Do not touch the aluminum fins of the unit. Doing so may result in injury.							
 <table border="1" data-bbox="340 1255 592 1413"> <tr> <td colspan="2" style="text-align: center;">CAUTION</td> </tr> <tr> <td colspan="2">BURST HAZARD</td> </tr> <tr> <td colspan="2">Open the service valves before the operation, otherwise there might be the burst.</td> </tr> </table>	CAUTION		BURST HAZARD		Open the service valves before the operation, otherwise there might be the burst.		<p>CAUTION</p> <p>BURST HAZARD Open the service valves before the operation, otherwise there might be the burst.</p>
CAUTION							
BURST HAZARD							
Open the service valves before the operation, otherwise there might be the burst.							

1 PRECAUTIONS FOR SAFETY

- Ensure that all Local, National and International regulations are satisfied.
- Read this “PRECAUTIONS FOR SAFETY” carefully before Installation.
- The precautions described below include the important items regarding safety. Observe them without fail.
- After the installation work, perform a trial operation (test run) to check for any problem.
Follow the Owner’s Manual to explain how to use and maintain the unit to the customer.
- Turn off the main power supply switch (or breaker) before the unit maintenance.
- Ask the customer to keep the Installation Manual together with the Owner’s Manual.

The manufacturer shall not assume any liability for the damage caused by not observing the description of this manual.

WARNING

General

- Before starting to install the air conditioner, read through the Installation Manual carefully, and follow its instructions to install the air conditioner.
- Only a qualified installer(*1) or qualified service person(*1) is allowed to do installation work. Inappropriate installation may result in water leakage, electric shock or fire.
- Do not use any refrigerant different from the one specified for complement or replacement. Otherwise, abnormally high pressure may be generated in the refrigeration cycle, which may result in a failure or explosion of the product or an injury to your body.
- Before opening the front panel of the indoor unit or service panel of the outdoor unit, set the circuit breaker to the OFF position. Failure to set the circuit breaker to the OFF position may result in electric shocks through contact with the interior parts. Only a qualified installer(*1) or qualified service person(*1) is allowed to remove the front panel of the indoor unit or service panel of the outdoor unit and do the work required.
- Before carrying out the installation, maintenance, repair or removal work, be sure to set the circuit breaker to the OFF position. Otherwise, electric shocks may result.
- Place a “Work in progress” sign near the circuit breaker while the installation, maintenance, repair or removal work is being carried out. There is a danger of electric shocks if the circuit breaker is set to ON by mistake.

- Only a qualified installer(*1) or qualified service person(*1) is allowed to undertake work at heights using a stand of 50 cm or more or to remove the front panel of the indoor unit to undertake work.
- Wear protective gloves and safety work clothing during installation, servicing and removal.
- Do not touch the aluminium fin of the unit. You may injure yourself if you do so. If the fin must be touched for some reason, first put on protective gloves and safety work clothing, and then proceed.
- Do not climb onto or place objects on top of the outdoor unit. You may fall or the objects may fall off of the outdoor unit and result in injury.
- When work is performed at heights, use a ladder which complies with the ISO 14122 standard, and follow the procedure in the ladder's instructions. Also wear a helmet for use in industry as protective gear to undertake the work.
- Before cleaning the filter or other parts of the outdoor unit, set the circuit breaker to OFF without fail, and place a "Work in progress" sign near the circuit breaker before proceeding with the work.
- Before working at heights, put a sign in place so that no-one will approach the work location, before proceeding with the work. Parts and other objects may fall from above, possibly injuring a person below. While carrying out the work, wear a helmet for protection from falling objects.
- Do not use the refrigerant other than R32 or R410A.
For the refrigerant type, check the outdoor unit to be combined.
- The refrigerant used by this air conditioner, follow to the outdoor unit.
- The air conditioner must be transported in stable condition. If any part of the product is broken, contact the dealer.
- When the air conditioner must be transported by hand, carry it by two or more people.
- Do not move or repair any unit by yourself. There is high voltage inside the unit. You may get electric shock while removing the cover and main unit.
- This appliance is intended to be used by expert or trained users in shops, in light industry, or for commercial use by lay persons.

Selection of installation location

- When the air conditioner is installed in a small room, provide appropriate measures to ensure that the concentration of refrigerant leakage occur in the room does not exceed the critical level.
- Do not install the air conditioner in a location that may be subject to a risk of exposure to a combustible gas. If a combustible gas leaks and becomes concentrated around the unit, a fire may occur.
- To transport the air conditioner, wear shoes with additional protective toe caps.

- To transport the air conditioner, do not take hold of the bands around the packing carton. You may injure yourself if the bands should break.
- Do not place any combustion appliance in a place where it is directly exposed to the wind of air conditioner, otherwise it may cause imperfect combustion.
- Do not install in a location where flammable gas leaks are possible. If the gas leak and accumulate around the unit, it may ignite and cause a fire.
- Install the indoor unit at least 2.5 m above the floor level since otherwise the users may injure themselves or receive electric shocks if they poke their fingers or other objects into the indoor unit while the air conditioner is running.

Installation

- Install the air conditioner securely in a location where the base can sustain the weight adequately. If the strength is not enough, the unit may fall down resulting in injury.
- Follow the instructions in the Installation Manual to install the air conditioner. Failure to follow these instructions may cause the product to fall down or topple over or give rise to noise, vibration, water leakage or other trouble.
- Carry out the specified installation work to guard against the possibility of high winds and earthquake. If the air conditioner is not installed appropriately, a unit may topple over or fall down, causing an accident.
- If refrigerant gas has leaked during the installation work, ventilate the room immediately. If the leaked refrigerant gas comes in contact with fire, noxious gas may generate.
- Use forklift to carry in the air conditioner units and use winch or hoist at installation of them.

Refrigerant piping

- Install the refrigerant pipe securely during the installation work before operating the air conditioner. If the compressor is operated with the valve open and without refrigerant pipe, the compressor sucks air and the refrigeration cycles is over pressurized, which may cause a injury.
- Tighten the flare nut with a torque wrench in the specified manner. Excessive tighten of the flare nut may cause a crack in the flare nut after a long period, which may result in refrigerant leakage.
- After the installation work, confirm that refrigerant gas does not leak. If refrigerant gas leaks into the room and flows near a fire source, such as a cooking range, noxious gas may be generated.

- When the air conditioner has been installed or relocated, follow the instructions in the Installation Manual and purge the air completely so that no gases other than the refrigerant will be mixed in the refrigerating cycle. Failure to purge the air completely may cause the air conditioner to malfunction.
- Nitrogen gas must be used for the airtight test.
- The charge hose must be connected in such a way that it is not slack.
- If refrigerant gas has leaked during the installation work, ventilate the room immediately. If the leaked refrigerant gas comes in contact with fire, noxious gas may be generated.

Electrical wiring

- Only a qualified installer(*1) or qualified service person(*1) is allowed to carry out the electrical work of the air conditioner. Under no circumstances must this work be done by an unqualified individual since failure to carry out the work properly may result in electric shocks and/or electrical leaks.
- To connect the electrical wires, repair the electrical parts or undertake other electrical jobs, wear gloves to provide protection for electricians and from heat, insulating shoes and clothing to provide protection from electric shocks. Failure to wear this protective gear may result in electric shocks.
- Use wiring that meets the specifications in the Installation Manual and the stipulations in the local regulations and laws. Use of wiring which does not meet the specifications may give rise to electric shocks, electrical leakage, smoking and/or a fire.
- Connect earth wire. (grounding work)
Incomplete grounding causes an electric shock.
- Do not connect earth wires to gas pipes, water pipes, and lightning conductor or telephone earth wires.
- After completing the repair or relocation work, check that the earth wires are connected properly.
- Install a circuit breaker that meets the specifications in the Installation Manual and the stipulations in the local regulations and laws.
- Install the circuit breaker where it can be easily accessed by the agent.
- When installing the circuit breaker outdoors, install one which is designed to be used outdoors.
- Under no circumstances the power wire must not be extended. Connection trouble in the places where the wire is extended may give rise to smoking and/or a fire.
- Electrical wiring work shall be conducted according to law and regulation in the community and Installation Manual. Failure to do so may result in electrocution or short circuit.

Test run

- Before operating the air conditioner after having completed the work, check that the electrical control box cover of the indoor unit and service panel of the outdoor unit are closed, and set the circuit breaker to the ON position. You may receive an electric shock if the power is turned on without first conducting these checks.
- If there is any kind of trouble (such as an error display has appeared, smell of burning, abnormal sounds, the air conditioner fails to cool or heat or water is leaking) has occurred in the air conditioner, do not touch the air conditioner yourself but set the circuit breaker to the OFF position, and contact a qualified service person. Take steps to ensure that the power will not be turned on (by marking “out of service” near the circuit breaker, for instance) until qualified service person(*1) arrives. Continuing to use the air conditioner in the trouble status may cause mechanical problems to escalate or result in electric shocks or other trouble.
- After the work has finished, use an insulation tester set (500V Megger) to check the resistance is 1MΩ or more between the charge section and the non-charge metal section (earth section). If the resistance value is low, a disaster such as a leak or electric shock is caused at user’s side.
- Upon completion of the installation work, check for refrigerant leaks and check the insulation resistance and water drainage. Then conduct a test run to check that the air conditioner is operating properly.

Explanations given to user

- Upon completion of the installation work, tell the user where the circuit breaker is located. If the user does not know where the circuit breaker is, he or she will not be able to turn it off in the event that trouble has occurred in the air conditioner.
- If the fan grille is damaged, do not approach the outdoor unit but set the circuit breaker to the OFF position, and contact a qualified service person(*1) to have the repairs done. Do not set the circuit breaker to the ON position until the repairs are completed.
- After the installation work, follow the Owner’s Manual to explain to the customer how to use and maintain the unit.

Relocation

- Only a qualified installer(*1) or qualified service person(*1) is allowed to relocate the air conditioner. It is dangerous for the air conditioner to be relocated by an unqualified individual since a fire, electric shocks, injury, water leakage, noise and/or vibration may result.
 - While carrying out the pump-down work shut down the compressor before disconnecting the refrigerant pipe. Disconnecting the refrigerant pipe with the service valve left open and the compressor still operating will cause air or other gas to be sucked in, raising the pressure inside the refrigeration cycle to an abnormally high level, and possibly resulting in rupture, injury or other trouble.
-

CAUTION

This Air Conditioner has adopted a refrigerant HFC (R32 or R410A) which does not destroy the ozone layer.

- As the R32 or R410A refrigerant is easily affected by impurities such as moisture, oxidized film, oil, etc., due to the high pressure, be careful not to allow the moisture, dirt, existing refrigerant, refrigerating machine oil, etc., to get mixed up in the refrigeration cycle during the installation work.
- A special tool for the R32 or R410A refrigerant is required for installation.
- Use a new and clean piping materials for the connecting pipe so that moisture and dirt are not mixed together during the installation work.
- When using existing pipes, follow the Installation Manual enclosed with the outdoor unit.

To disconnect the appliance from main power supply.









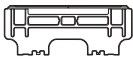

- This appliance must be connected to the main power supply by means of a switch with a contact separation of at least 3 mm.

The installation fuse (all types can be used) must be used for the power supply line of this air conditioner.

Install the indoor unit at least 2.5 m above the floor level since otherwise the users may injure themselves or receive electric shocks if they poke their fingers or other objects into the indoor unit while the air conditioner is running.

(*1) Refer to the “Definition of Qualified Installer or Qualified Service Person.”

2 ACCESSORY PARTS

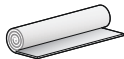
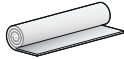
No.	Part name	Q'ty	Shape	Usage
①	Installation plate	1		
②	Wireless remote controller	1		
③	Battery	2		
④	Remote controller holder	1		
⑤	Toshiba Ultra pure filter	2		
⑥	Mounting screw	10		
⑦	Flat head wood screw	2		
⑧	Screw	2		
⑨	Owner's Manual	1		(Hand over to customers) (For other languages that do not appear in this Owner's Manual, please refer to the enclosed CD-R.)
⑩	Installation Manual	1		(Hand over to customers) (For other languages that do not appear in this Installation Manual, please refer to the enclosed CD-R.)
⑪	Decorative fabric (dark gray)	1		
⑪	Decorative fabric (light gray)	1		
⑫	CD-ROM	1	-	Owner's Manual and Installation Manual.

■ Decorative Fabric Installation

The decorative fabric for cover on the air inlet grille of indoor unit was put in the accessories. User can use it as required.

The method of installation is as follows.

1. Remove the air inlet grille.

Open the air inlet grille upward and pull it toward you.

As shown on figure as below.

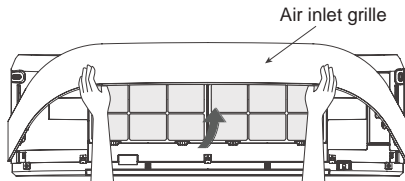

2. Prepare the fabric that you choose for install.

3. Insert the fabric into the left and right side of the air inlet grille and adjust corner position of decorative fabric is smooth.

Attach the hook and loop of velcro tape fully together.

As shown on figure as below.

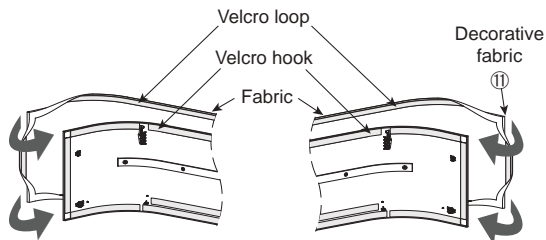

4. Insert the fabric into the top and bottom side of the air inlet grille.

Attach the hook and loop of velcro tape fully together.

As shown on figure as below.

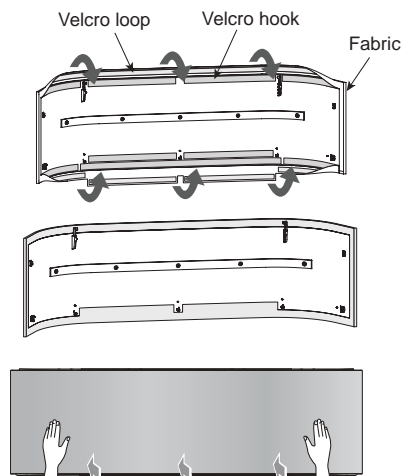

5. Reassembly the air inlet grille by reverse process of 1.

NOTE

- The tightness of the fabric depends on attaching the hook and loop of velcro around the air inlet grille, take appropriate action.

CAUTION

- If clean decorative fabric by washing, it may affect to appearance and fitting of the decorative fabric.
- Recommend to use vacuum cleaner to removing the dusts from decorative fabric.

3 SELECTION OF INSTALLATION PLACE

WARNING

-
- **Install the air conditioner at enough strong place to withstand the weight of the unit.**
If the strength is not enough, the unit may fall down resulting in injury.
-

CAUTION

-
- **Do not install in a location where flammable gas may leaks are possible.**
If the gas leak and accumulate around the unit, it may ignite and cause a fire.
 - **When an outdoor unit using R32 refrigerant is combined with indoor unit, be attention to the floor area in the room to be installed.**
Indoor units cannot be installed in rooms with a floor area less than the minimum floor area.
For details, follow the Installation Manual to the outdoor unit.
-

Upon approval of the customer, install the air conditioner in a place that satisfies the following conditions.

- Place where the unit can be installed horizontally.
- Place where a sufficient servicing space can be ensured for safety maintenance and check.
- Place where drained water will not cause any problem.

Avoid installing in the following places.

Select a location for the indoor unit where the cool or warm air will circulate evenly.

Avoid installation in the following kinds of locations.

- Saline area (coastal area).
- Locations with acidic or alkaline atmospheres (such as areas with hot springs, factories where chemicals or pharmaceuticals are made and places where the exhaust air from combustion appliances will be sucked into the unit).
Doing so may cause the heat exchanger (its aluminum fins and copper pipes) and other parts to become corroded.
- Locations with atmospheres with mist of cutting oil or other types of machine oil.
Doing so may cause the heat exchanger to become corroded, mists caused by the blockage of the heat exchanger to be generated, the plastic parts to be damaged, the heat insulators to peel off, and other such problems to result.
- Places where iron or other metal dust is present. If iron or other metal dust adheres to or collects on the interior of the air conditioner, it may spontaneously combust and start a fire.
- Locations where vapors from food oils are formed (such as kitchens where food oils are used).
Blocked filters may cause the air conditioner's performance to deteriorate, condensation to form, the plastic parts to be damaged, and other such problems to result.
- Locations near obstructions such as ventilation openings or lighting fixtures where the flow of the blown air will be disrupted (a disruption of the air flow may cause the air conditioner's performance to deteriorate or the unit to shut down).
- Locations where an in-house power generator is used for the power supply.
The power line frequency and voltage may fluctuate, and the air conditioner may not work properly as a result.
- On truck cranes, ships or other moving conveyances.
- The air conditioner must not be used for special applications (such as for storing food, plants, precision instruments or art works).
(The quality of the items stored may be degraded.)
- Locations where high frequencies are generated (by inverter equipment, in-house power generators, medical equipment or communication equipment).
(Malfunctioning or control trouble in the air conditioner or noise may adversely affect the equipment's operation.)
- Locations where there is anything under the unit installed that would be compromised by wetness.
(If the drain has become blocked or when the humidity is over 80%, condensation from the indoor unit will drip, possibly causing damage to anything underneath.)
- In the case of the wireless type of system, rooms with the inverter type of fluorescent lighting or locations exposed to direct sunlight.
(The signals from the wireless remote controller may not be sensed.)
- Locations where organic solvents are being used.
- The air conditioner cannot be used for liqueed carbonic acid cooling or in chemical plants.
- Location near doors or windows where the air conditioner may come into contact with high-temperature, high-humidity outdoor air.
(Condensation may occur as a result.)
- Locations where special sprays are used frequently.

■ Installation diagram of Indoor unit

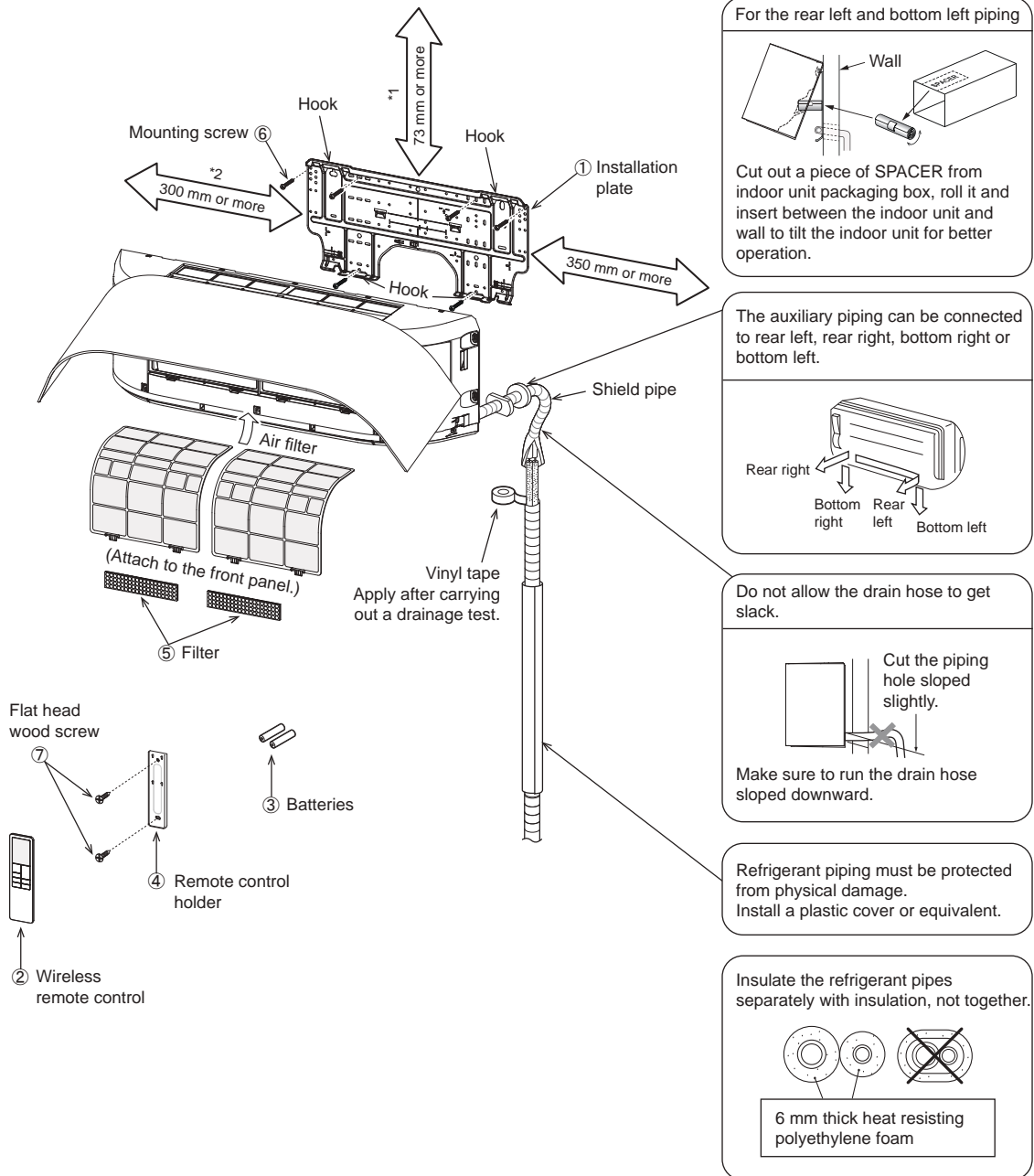

■ Installation space

The indoor unit shall be installed at least 2.5 m height.

Also it must be avoided to put anything on top of the indoor unit.

*1 Reserve space required to install the indoor unit and for service work.

Keep 73 mm or more for clearance between top plate of the indoor unit and the ceiling surface.

*2 Provide a space as shown for service clearance for the cross flow fan.

■ Installation place

- A place which provides the spaces around the indoor unit as shown in the above diagram.
- A place where there is no obstacle near the air inlet and outlet.
- A place that allows easy installation of the piping to the outdoor unit.
- A place which allows the front panel to be opened.

⚠ CAUTION

- Direct sunlight to the indoor unit's wireless receiver should be avoided.
- The microprocessor in the indoor unit should not be too close to RF noise sources.
(For details, see the owner's manual.)

■ Wireless remote controller

- A place where there are no obstacles such as a curtain that may block the signal from the indoor unit.
- Do not install the remote controller in a place exposed to direct sunlight or close to a heating source, such as a stove.
- Keep the remote controller at least 1 m apart from the nearest TV set or stereo equipment.
(This is necessary to prevent image disturb-bounces or noise interference.)
- The location of the remote controller should be determined as shown below.

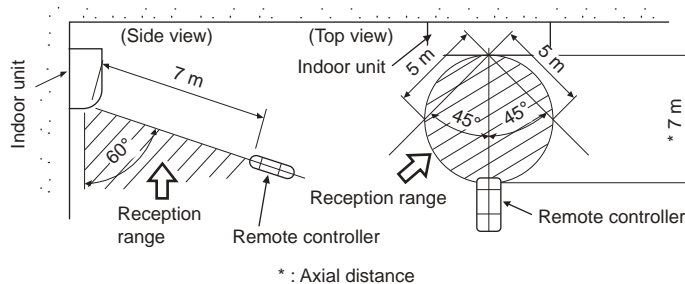

4 INSTALLATION OF INDOOR UNIT

WARNING

Install the air conditioner certainly to sufficiently withstand the weight.
If the strength is insufficient, the unit may fall down resulting in human injury.
Perform a specified installation work to guard against strong wind or earthquake.
An incomplete installation can cause accidents by the units falling and dropping.

REQUIREMENT

Strictly comply with the following rules to prevent damage of the indoor units and human injury.

- Do not put a heavy article on the indoor unit. (Even units are packaged)
- Carry in the indoor unit as it is packaged if possible. If carrying in the indoor unit unpacked by necessity, be sure to use buffering cloth, etc. to not damage the unit.
- To move the indoor unit, do not apply force to the refrigerant pipe, drain pan, foamed parts, or resin parts, etc.
- Carry the package by two or more persons, and do not bundle it with plastic band at positions other than specified.

Be careful to the following items when installing the unit.

- Considering air discharge direction, select an installation place where discharge air can circulate evenly in a room. Avoid to install the unit at place with “**NO GOOD**” mark in the right figure.

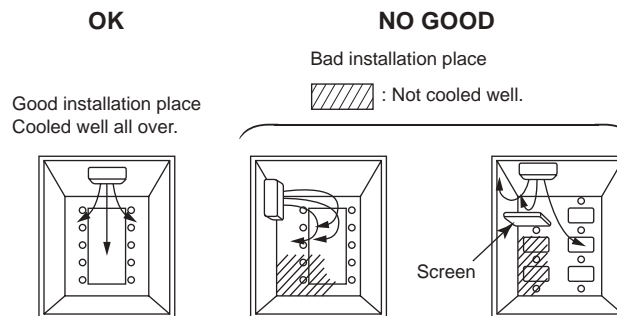

5 CUTTING A HOLE AND MOUNTING INSTALLATION PLATE

■ Cutting a hole

In case of installing the refrigerant pipes from the rear:

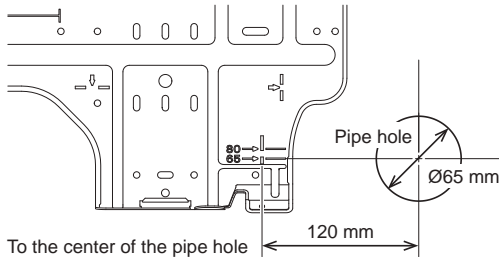

1. After determining the pipe hole position on the mounting plate (➔), drill the pipe hole (Ø65 mm) at a slight downward slant to the outdoor side.

NOTE

- When drilling a wall that contains a metal lath, wire lath or metal plate, be sure to use a pipe hole brim ring sold separately.

■ Mounting the installation plate

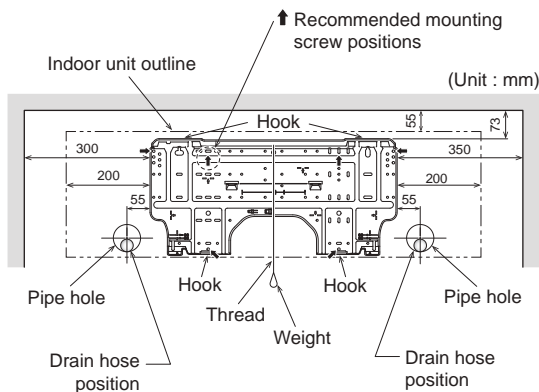

■ Space allows under the indoor unit

- Space allows for moving range of the air inlet grille and horizontal louver in operation above curtain rails, window cornice or other objects.

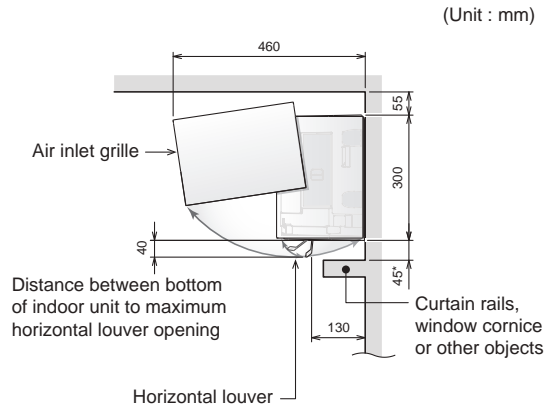

⚠ CAUTION

- If have curtain rails, window cornice or other objects, allow space from the indoor unit should be 45 mm or more.
- If allow space is less than 45 mm, this can affect the opening and closing of the air inlet grille and the horizontal louver.
- However, there should be no objects in the air outlet position. It will block the air flow direction and drop performance.

■ When the installation plate is directly mounted on the wall

1. Securely fit the installation plate onto the wall by screwing it in the upper and lower parts to hook up the indoor unit.
2. To mount the installation plate on a concrete wall with anchor bolts, utilize the anchor bolt holes as illustrated in the above figure.
3. Install the installation plate horizontally in the wall.

CAUTION

When installing the installation plate with a mounting screw, do not use the anchor bolt hole. Otherwise the unit may fall down and result in personal injury and property damage.

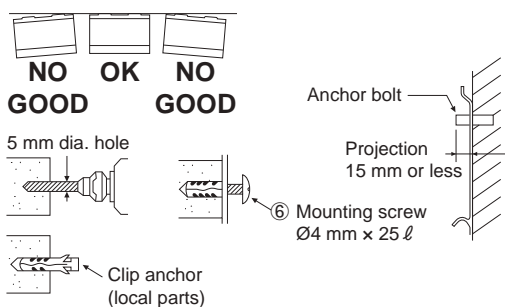

CAUTION

Failure to firmly install the unit may result in personal injury and property damage if the unit falls.

- In case of block, brick, concrete or similar type walls, make 5 mm dia. holes in the wall.
- Insert clip anchors for appropriate mounting screws.

NOTE

- Secure four corners and lower parts of the installation plate with 6 mounting screws to install it.

6 PIPING AND DRAIN HOSE INSTALLATION

■ Piping and drain hose forming

- Since dewing results in a machine trouble, make sure to insulate both connecting pipes. (Use polyethylene foam as insulating material.)
- The connection of pipes can be installed in the following directions.

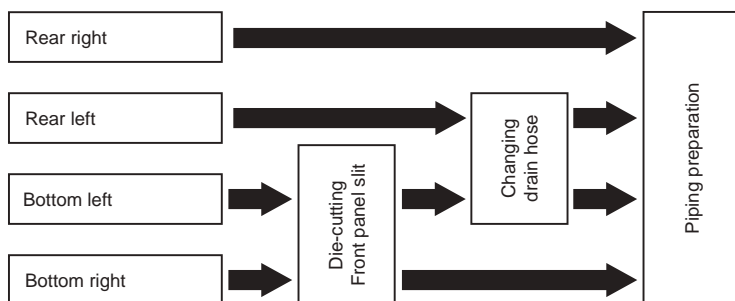

- Rear right

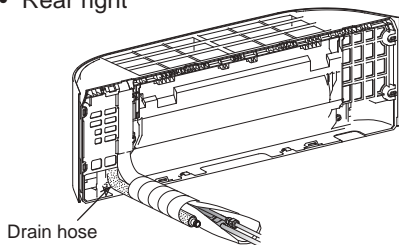

- Rear left

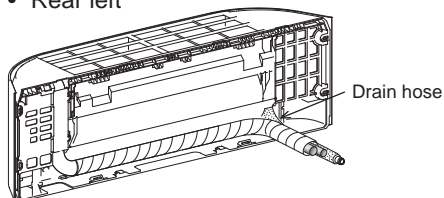

- Bottom right

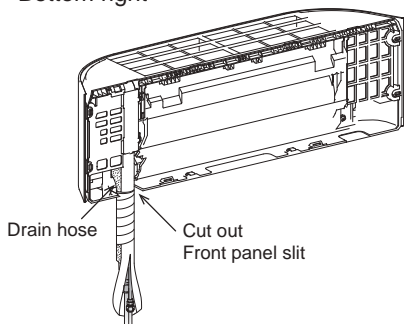

- Bottom left

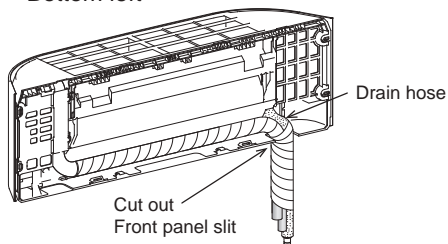

1. Die-cutting Front panel slit

- Cut out the slit on the bottom left or bottom right side of the Front panel for the bottom left or bottom right connection with a coping saw.

2. Changing drain hose

- The factory default of the drain hose is installed on the right side.
- For bottom-leftward connection and rear leftward connection's piping, it is necessary to change the drain hose and drain cap.

How to cutting the Front panel

- To connect piping to the bottom side, the Front panel must be cut off.
- The front panel can be removed by removing 2 screws securing then secure remove the front panel from the main body.
 - ※ Be careful of air inlet grille fall down that may cause of injure or part damage.

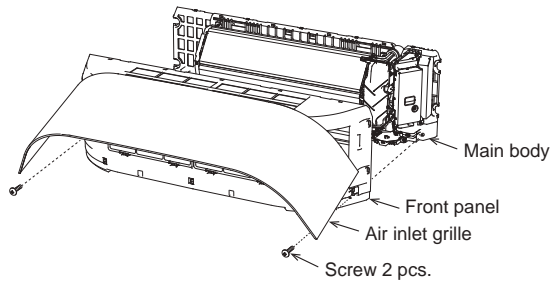

- The marking for cutting are indicated on the inside of the Front panel in the following positions.

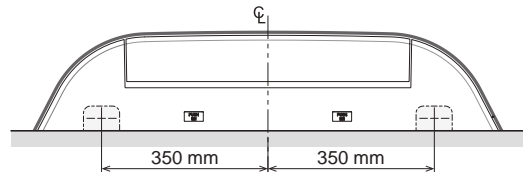

- Cut off the pipe exist from inside of Front panel using a coping saw or an equivalent tool.
- The plastic burrs from the cutting process should be removed with a half round file or an equivalent tool.

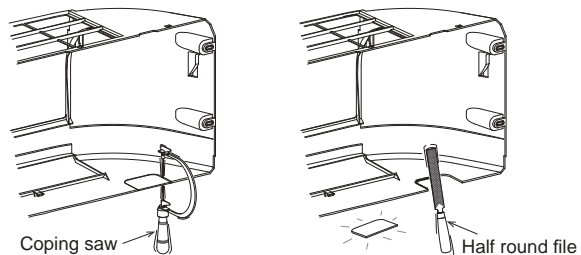

CAUTION

When cutting the Front panel, be careful of cutting tools and any sharp edges of plastic. It can cause injuries.

How to remove the drain hose

- Removed fixing screw of LED set then pull out it from the main body.
- Removed 2 screws to fix drain pan then secure remove the drain pan from the main body.

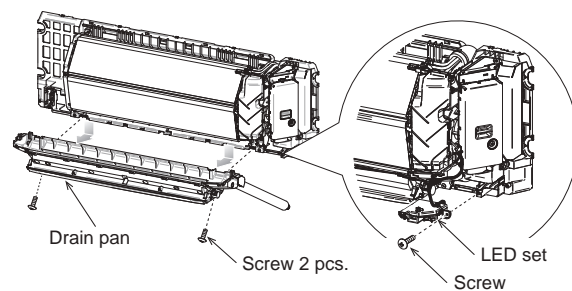

- The drain hose can be removed by removing the screw securing the drain hose then secure rotate steel plate of drain hose to out of the Drain pan and pulling out the drain hose.

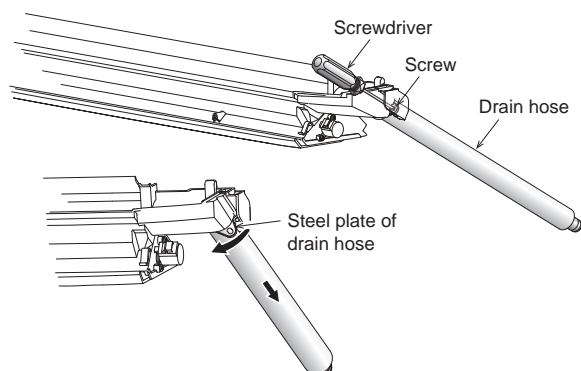

How to fix the drain hose

- To install the drain hose, insert the drain hose firmly until the connection part contacts with heat insulator, secure push steel plate of drain hose to predetermined position of Drain pan then fix it by original screw.

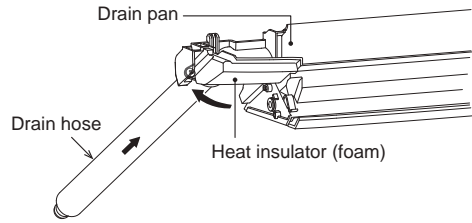

CAUTION

When removing or install the drain hose, be careful of any sharp edges of steel plate. The edges can cause injuries.

How to remove the drain cap

- Clip the drain cap by needle-nose pliers and pull out.

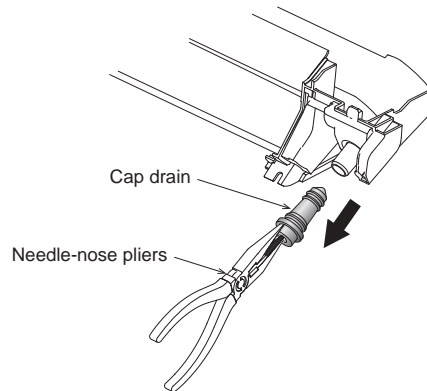

How to fix the drain cap

- Insert hexagonal wrench (dia. 4 mm) in a center head.

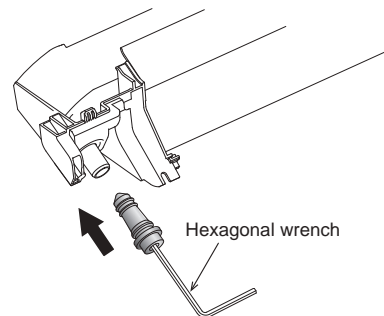

- Firmly insert the drain cap.

Do not apply lubricating oil (refrigerant machine oil) when inserting the drain cap. Application causes deterioration and drain leakage from the plug.

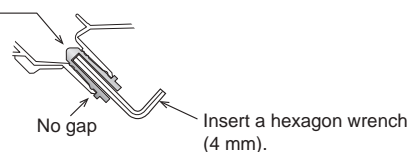

CAUTION

Firmly insert the drain hose and drain cap; otherwise, water may leak.

■ Left-hand connection with piping

- Bend the connecting pipe so that it is laid within 43 mm above the wall surface. If the connecting pipe is laid exceeding 43 mm above the wall surface, the indoor unit may unstably be set on the wall. When bending the connecting pipe, make sure to use a spring bender so as not to crush the pipe.

Bend the connecting pipe within a radius of 30 mm.

To connect the pipe after installation of the unit (figure)

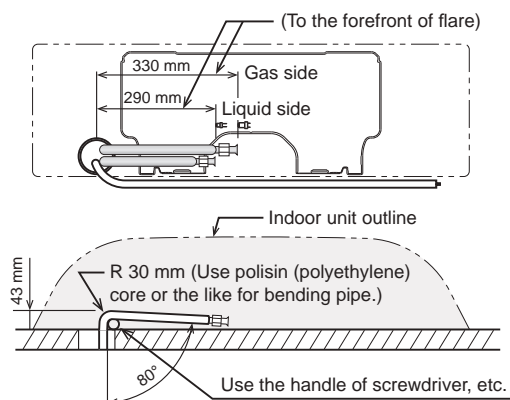

NOTE

If the pipe is bent incorrectly, the indoor unit may unstably be set on the wall. After passing the connecting pipe through the pipe hole, connect the connecting pipes to the auxiliary pipes and wrap the facing tape around them.

⚠ CAUTION

- Bind the auxiliary pipes (two), power supply and connecting cable with facing tape tightly.

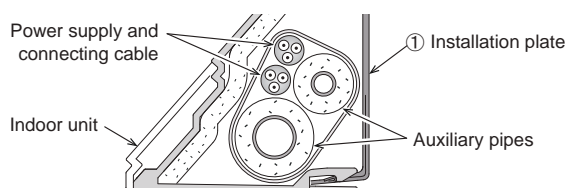

- Carefully arrange pipes so that any pipe does not stick out of the rear plate of the indoor unit.
- Carefully connect the auxiliary pipes and connecting pipes to one another and cut off the insulating tape wound on the connecting pipe to avoid double-taping at the joint; moreover, seal the joint with the vinyl tape, etc.
- Since dewing results in a machine trouble, make sure to insulate both connecting pipes. (Use polyethylene foam as insulating material.)
- When bending a pipe, carefully do it, not to crush it.

7 INDOOR UNIT FIXING

1. Pass the pipe through the hole in the wall, and hook the indoor unit on the installation plate at the upper hooks.
2. Swing the indoor unit to right and left to confirm that it is firmly hooked up on the installation plate.
3. While pressing the indoor unit onto the wall, hook it at the lower part on the installation plate. Pull the indoor unit toward you to confirm that it is firmly hooked up on the installation plate.

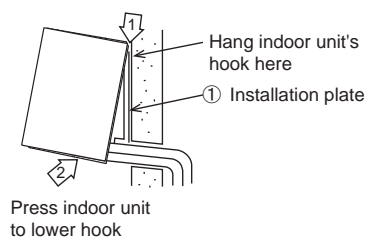

- For detaching the indoor unit from the installation plate, pull the indoor unit toward you while pushing its bottom up at the specified parts.

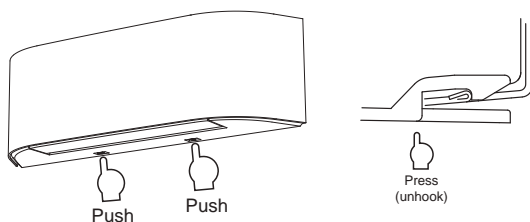

⚠ CAUTION

MOUNTING INDOOR UNIT TO THE INSTALLATION PLATE

- The lower part of indoor unit may float, due to the condition of piping and installer cannot fix it to the installation plate. In that case, use the screws provided to fix the indoor unit with the installation plate.
- Especially when the pipes are pulled out to the left side, the indoor unit must be screwed to the installation plate.

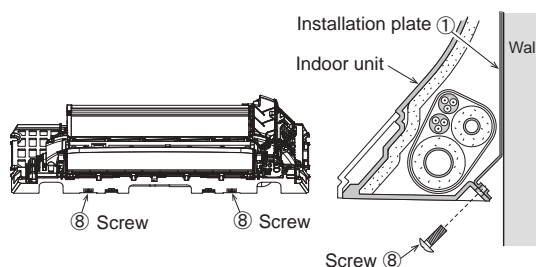

DIRECTLY MOUNTING INDOOR UNIT TO THE WALL

- In case left side or right of indoor unit may float, the provided screws should be used to fix the indoor unit directly to the wall at the predetermined position.
- In the case of block, brick, concrete or similar type wall, determining the mount screw position on the wall can be used symbol (▶) on the main body of indoor unit for drill hole to insert clip anchors for appropriate mounting screw.

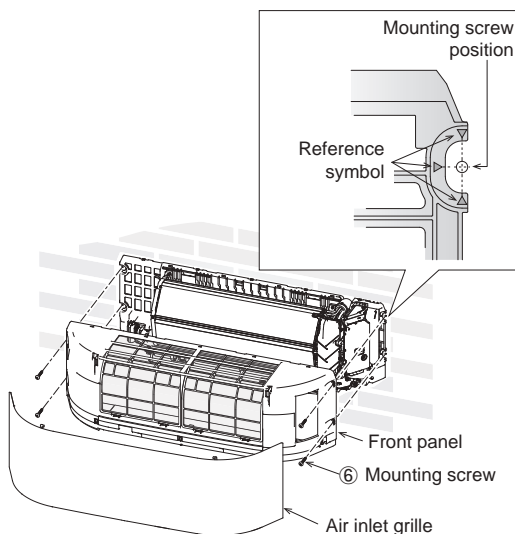

8 DRAINAGE

1. Run the drain hose sloped downwards.

NOTE

- Hole should be made at a slight downward slant on the outdoor side.

2. Put water in the drain pan and make sure that the water is drained out of doors.

3. When connecting extension drain hose, insulate the connecting part of extension drain hose with shield pipe.

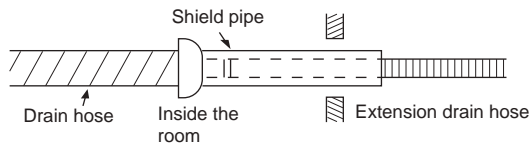
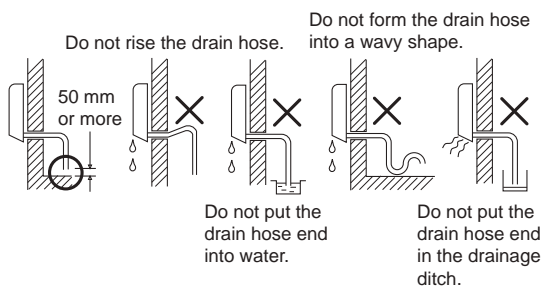

CAUTION

Arrange the drain pipe for proper drainage from the unit.
Improper drainage can result in dew-dropping.

This air conditioner has the structure designed to drain water collected from dew, which forms on the back of the indoor unit, to the drain pan. Therefore, do not store the power cord and other parts at a height above the drain guide.

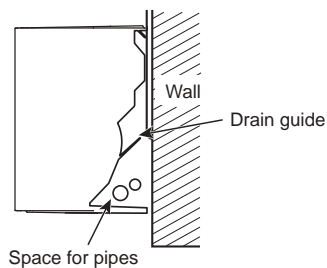

9 REFRIGERANT PIPING

CAUTION

Use flare nuts that are included with the unit.
Using different flare nuts may cause refrigerant gas leakage.

■ Refrigerant Piping

Use the following item for the refrigerant piping.

Material: Seamless phosphorous de-oxidized copper pipe.

6.35, 9.52 and 12.7 wall thickness 0.8 mm or more.

15.88 wall thickness 1.0 mm or more.

REQUIREMENT

When the refrigerant pipe is long, provide support brackets at intervals of 2.5 - 3 m to clamp the refrigerant pipe. Otherwise, abnormal sound may be generated.

CAUTION

IMPORTANT 4 POINTS FOR PIPING WORK

1. Reusable mechanical connectors and flared joints are not allowed indoors. When mechanical connectors are reused indoors, sealing parts shall be renewed.
When flared joints are reused indoors, the flare part shall be re-fabricated.
2. Tight connection (between pipes and unit)
3. Evacuate the air in the connecting pipes by using VACUUM PUMP.
4. Check the gas leakage. (Connected points)

■ Pipe size

(dia.: mm)

MMK-	UP0051 to UP0121 type	UP0151 to UP0181 type
Gas side	9.5	12.7
Liquid side	6.4	6.4

■ Permissible Piping Length and Height Difference

They vary according to the outdoor unit.
For details, refer to the Installation Manual attached to the outdoor unit.

Flaring

- Cut the pipe with a pipe cutter.
Remove burrs completely.
Remaining burrs may cause gas leakage.
- Insert a flare nut into the pipe, and flare the pipe.
As the flaring sizes of R32 or R410A differ from those of refrigerant R22, the flare tools newly manufactured for R32 or R410A are recommended.
However, the conventional tools can be used by adjusting projection margin of the copper pipe.

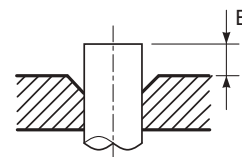

▼ Projection margin in flaring: B (Unit: mm)

RIDGID (Clutch type)

Outer dia. of copper pipe	Tool used	Conventional tool used
6.4, 9.5	0 to 0.5	1.0 to 1.5
12.7		

▼ Flaring dia. meter size: A (Unit: mm)

Outer dia. of copper pipe	A ^{+0.4} _{-0.4}
6.4	9.1
9.5	13.2
12.7	16.6

CAUTION

- Do not scratch the inner surface of the flared part when removing burrs.
- Flare processing under the condition of scratches on the inner surface of flare processing part will cause refrigerant gas leak.
- Check that the flared part is not scratched, deformed, stepped, or flattened, and that there are no chips adhered or other problems, after flare processing.
- Do not apply refrigerating machine oil to the flare surface.

* In case of flaring for R32 or R410A with the conventional flare tool, pull it out approx. 0.5 mm more than that for R22 to adjust to the specified flare size. The copper pipe gauge is useful for adjusting projection margin size.

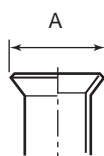

Tightening connection

CAUTION

- Do not apply excessive torque. Otherwise, the nut may crack depending on the conditions.

(Unit: N•m)

Outer dia. of copper pipe	Tightening torque
6.4 mm (dia.)	14 to 18 (1.4 to 1.8 kgf•m)
9.5 mm (dia.)	33 to 42 (3.3 to 4.2 kgf•m)
12.7 mm (dia.)	50 to 62 (5.0 to 6.2 kgf•m)

▼ Tightening torque of flare pipe connections

Pressure of R32 or R410A is higher than that of R22. (Approx. 1.6 times) Therefore, using a torque wrench, tighten the flare pipe connecting sections which connect the indoor and outdoor units of the specified tightening torque.

Incorrect connections may cause not only a gas leak, but also a trouble of the refrigeration cycle. Align the centres of the connecting pipes and tighten the flare nut as far as possible with your fingers. Then tighten the nut with a spanner and torque wrench as shown in the figure.

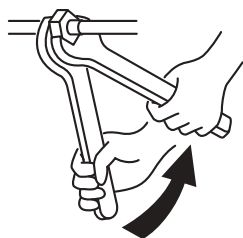

Work using double spanner

REQUIREMENT

Tightening with an excessive torque may crack the nut depending on installation conditions. Tighten the nut within the specified tightening torque.

Piping with outdoor unit

- Shape of valve differs according to the outdoor unit.
For details of installation, refer to the Installation Manual of the outdoor unit.

Heat insulation

Heat insulation for the pipes should be done separately for the liquid side and gas side. Because both of the liquid and gas side pipes become a low temperature during cooling operation, sufficient heat insulation should be done to prevent condensation.

- Heat insulator with a heat resistance of 120°C or more must be used for the gas side pipe.
- The pipe connection section of the indoor unit must be heat insulated securely and compactly with the attached heat insulator.

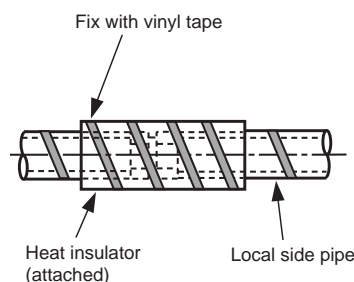

■ Airtight test / Air purge, etc.

For air tightness test, vacuum drying and adding refrigerant, refer to the Installation Manual attached to the outdoor unit.

CAUTION

Do not supply power to the indoor unit until the airtight test and vacuuming are completed. (If the indoor unit is powered on, the pulse motor valve is fully closed, which extends the time for vacuuming.)

■ Open fully valves of the outdoor unit

Open the valve of the outdoor unit fully. A hexagonal wrench is required for opening the valve.
For details, refer to the Installation Manual attached to the outdoor unit.

■ Gas leak check

Check with a leak detector or soap water whether gas leaks or not, from the pipe connecting section or cap of the valve.

REQUIREMENT

Use a leak detector manufactured exclusively HFC refrigerant (R410A, R134a, R32, etc.).

10 ELECTRICAL CONNECTION

WARNING

1. **Using the specified wires, ensure to connect the wires, and fix wires securely so that the external tension to the wires do not affect the connecting part of the terminals.**

Incomplete connection or fixation may cause a fire, etc.

2. **Be sure to connect earth wire. (grounding work)**

Incomplete grounding cause an electric shock.

Do not connect ground wires to gas pipes, water pipes, lightning rods or ground wires for telephone wires.

3. **Appliance shall be installed in accordance with national wiring regulations.**

Capacity shortage of power circuit or incomplete installation may cause an electric shock or a fire.

REQUIREMENT

- For power supply wiring, strictly conform to the Local Regulation in each country.
- For wiring of power supply of the outdoor units, follow the Installation Manual of each outdoor unit.
- Perform the electric wiring so that it does not come to contact with the high-temperature part of the pipe.
The coating may melt resulting in an accident.
- After connecting wires to the terminal blocks, provide a trap and fix wires with the cord clamp.
- Run the refrigerant piping line and control wiring line in the same line.
- Do not turn on the power of the indoor unit until vacuuming of the refrigerant pipes completes.

CAUTION

- **For communication line, use wires with the same type and size. If each wire has a different type and size from another one, it will cause a communication trouble.**
- If incorrect/incomplete wiring is carried out, it will cause an electrical fire or smoke.
- Install an earth leakage breaker that is not tripped by shock waves. If an earth leakage breaker is not installed, an electric shock may be caused.
- Use the cord clamps attached to the product.
- Do not damage or scratch the conductive core and inner insulator of power and system interconnection wires when peeling them.
- Use the power supply wire and control wires of specified thickness, type, and protective devices required.
- Do not connect 208V – 240V power to the terminal blocks (Uv (U1)), (Uv (U2)), (A), (B) for control wiring.
(Otherwise, the system will fail.)
- Perform the electric wiring so that it does not come to contact with the high-temperature part of the pipe.
The coating may melt resulting in an accident.

■ Power supply wire and communication wires specifications

Power supply wire and communication wires are procured locally.

For the power supply specifications, follow the table below. Power supply wiring and communication wiring are to be procured locally.

For specifications of the power capacity of the outdoor unit and the power supply wires, refer to the Installation Manual supplied with the outdoor unit.

Indoor unit power supply

- Prepare an exclusive power supply for the indoor unit independently of the outdoor unit.
- Arrange the power supplies to the indoor and outdoor units, so that a common earth leakage breaker and main switch can be used.
- Power supply wire specification: Cable 3-core 2.5 mm², **in conformity with Design H07RN-F or 60245 IEC 57.**

▼ Power supply

Power supply	220-240V ~ 50Hz 208-230V ~ 60Hz
Power supply switch/Earth leakage breaker or power supply wiring/fuse rating for indoor units should be selected by the accumulated total current values of the indoor units.	
Power supply wiring	Below 50 m 2.5 mm ²

Control wiring, Central controller wiring

- Use a 2 core non polarity wire.
- To prevent any possible noise issues, use a shielded 2 core wire.
- The total stated length of communication wiring is determined by the interconnecting length of indoor to outdoor wire plus the length of the central control communication wire.

▼ Communication line

TU2C-Link models (U series) can be combined with TCC-Link models (other than U series).

For details of communication type, refer to the following table.

Communication type and model names

Communication type	TU2C-Link (U series and future models)	TCC-Link (Other than U series)
Outdoor unit	MMY-MUP*** ↑ This letter indicates U series model.	Other than U series MMY-MHP*** MCY-MHP*** MMY-MAP***
Indoor unit	MM*-UP*** ↑ This letter indicates U series model.	Other than U series MM*-AP***
Wired remote controller	RBC-ASCU*** ↑ This letter indicates U series model.	Other than U series
Wireless remote controller kit & receiver unit	RBC-AXU*** ↑ This letter indicates U series model.	Other than U series

U series outdoor unit : SMMS-u (MMY-MUP*)**

Other than U series outdoor unit : SMMS-i, SMMS-e etc. (MMY-MHP*)**

<In the case of combining with outdoor units of Super Modular Multi System u series (SMMS-u)>

Uv line and Uc line (L2, L3, L4) (2-core shield wire, non-polarity)	Wire size : 0.5 mm ² 0.75 to 1.25 mm ²	(Up to 500 m) (Up to 1000 m)
Uh line (L1) (2-core shield wire, non-polarity)	Wire size : 0.75 to 1.25 mm ² 2.0 mm ²	(Up to 1000 m) (Up to 2000 m)

- **U (v, h, c)** line means of control wiring.
Uv line : Between indoor and outdoor units.
Uh line : Central control line.
Uc line : Between outdoor and outdoor units.
- **Uv line and Uc line** are independent from another refrigerant line. Total length of **Uv** and **Uc** lines (**L3+L4**) in each refrigerant line is up to 1000 m.

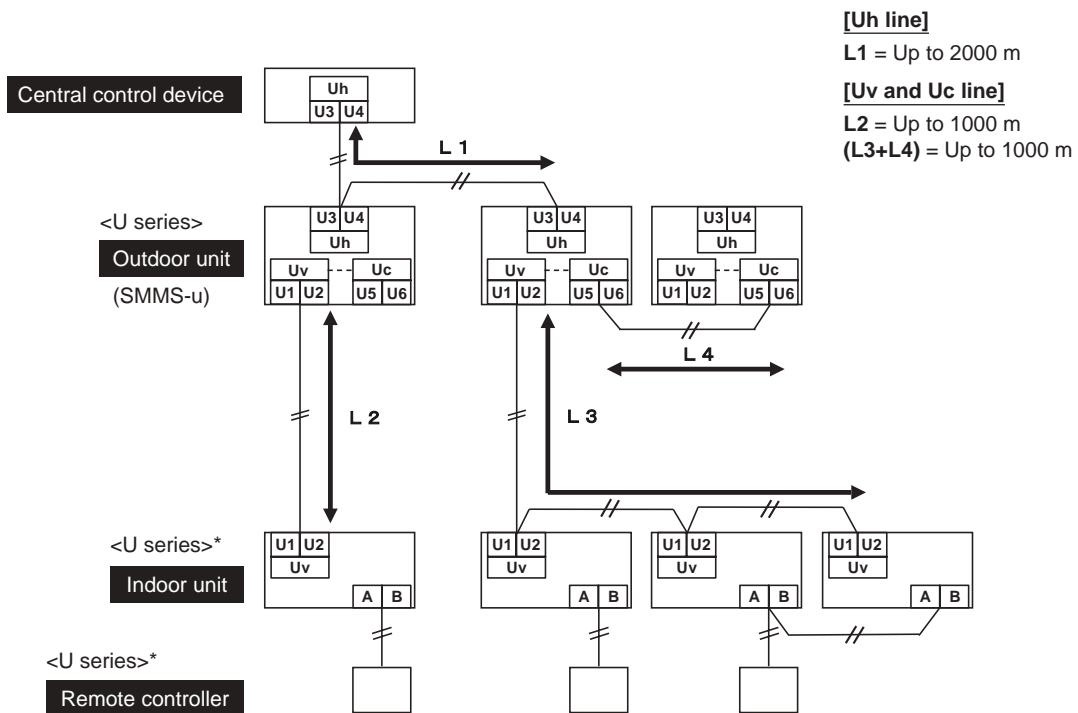

* Even if the indoor unit and the remote controller are "other than U series", the wiring specification are the same.

<In the case of combining with outdoor units other than Super Modular Multi System u series (SMMS-u)>

Control wiring between indoor units, and outdoor unit (L2, L3) (2-core shield wire, non-polarity)	Wire size : 1.25 mm ² (Up to 1000 m) 2.0 mm ² (Up to 2000 m)
Central control line wiring (L1) (2-core shield wire, non-polarity)	
Control wiring between outdoor units (L4) (2-core shield wire, non-polarity)	Wire size : 1.25 to 2.0 mm ² (Up to 100 m)

- The length of the communication line (L1+L2+L3) means the total length of the inter-unit wire length between indoor and outdoor units added with the central control system wire length.

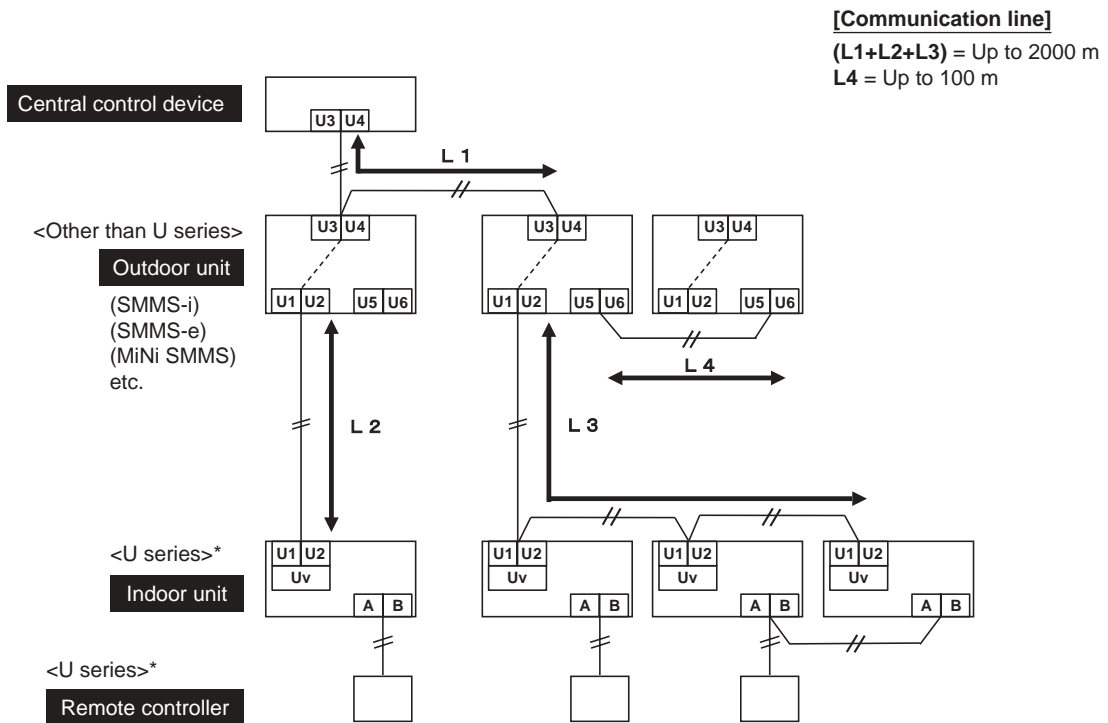

* Even if the indoor unit and the remote controller are "other than U series", the wiring specification are the same.

Wired remote controller wiring

This wiring is not required when using the supplied wireless remote controller.

- For wiring remote controllers a 2 core non polarity wire must be used.

Wired remote controller wiring, remote controller inter-unit wiring	Wire size: 0.5 mm ² to 2.0 mm ²	
Total wire length of wired remote controller wiring and remote controller inter-unit wiring = L + L1 + L2 + ... Ln	In case of wired type only	Up to 500 m
	In case of wireless type included	Up to 400 m
Total wire length of wired remote controller inter-unit wiring = L1 + L2 + ... Ln	Up to 200 m	

CAUTION

- **The remote controller wire (Communication line) and AC 208-240V wires cannot be parallel to contact each other and cannot be stored in the same conduits. If doing so, a trouble may be caused on the control system due to noise, etc.**
- If U series models (TU2C-Link) are combined with models other than U series (TCC-Link), the wiring specifications and maximum number of connectable indoor units will be changed. Pay attentions to their communication specifications when carrying out the installation, maintenance, or repair. For its details, refer to the "Communication line" in **10 Electrical connection**.

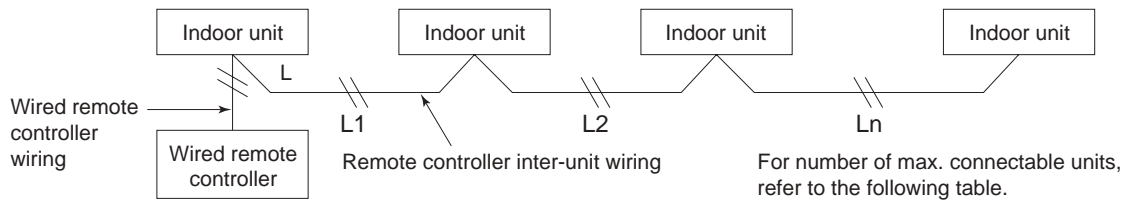

Max. number of connectable indoor units, and communication type

	Unit type							
	U series	U series	U series	U series	*	*	*	*
Outdoor unit	U series	U series	U series	U series	*	*	*	*
Indoor unit	U series	U series	*	*	U series	U series	*	*
Remote controller	U series	*	U series	*	U series	*	U series	*
Communication type	TU2C-Link		TCC-Link					
Max. number of connectable unit	16		8					

* : Other than U series

■ Control wiring between indoor and outdoor units

NOTE

- A wiring diagram below is an example for connection to SMMS-u series. For connecting to other outdoor unit series, refer to the Installation Manual attached to the outdoor unit to be connected.

▼ Wiring example

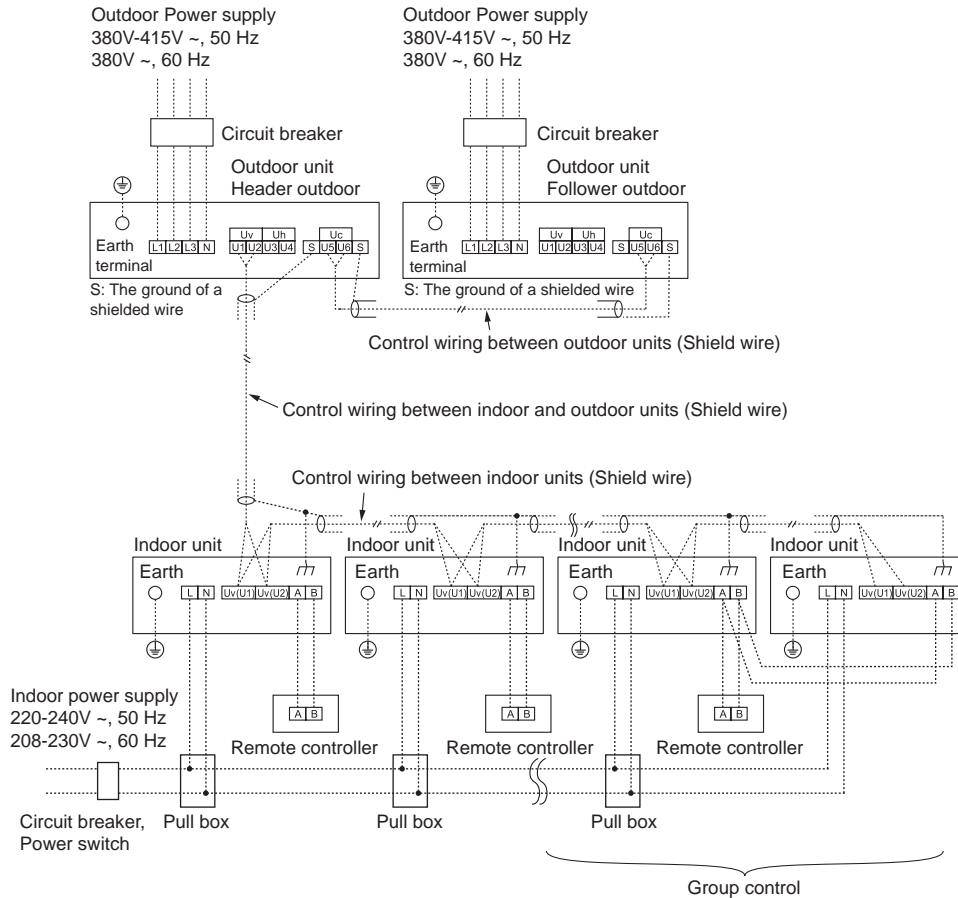

■ Address setup

Set up the addresses as per the Installation Manual supplied with the outdoor unit.

■ Wired remote controller wiring

- As the wired remote controller wire has non-polarity, there is no problem if connections to indoor unit terminal blocks A and B are reversed.

▼ Wiring diagram

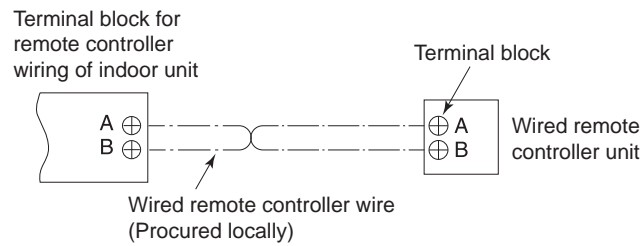

■ Wiring Connection

How to connect the power supply wiring and control wiring

The power supply wire and the control wire can be connected without removing the front panel.

REQUIREMENT

Connect the power supply wire after connecting the control wire for this model.

1. Remove the air inlet grille.
Open the air inlet grille upward and pull it toward you.
2. Remove the terminal cover and the clamp base.
3. Insert the power supply wire and control wire (according to the local rule) into the pipe hole on the wall.
4. Take the power supply wire out of the cable slot on the rear panel so that it protrudes about 150 mm from the front.
5. Insert the control wire fully into the control/wired remote controller terminal block (Uv (U1)), (Uv (U2)), (A), (B) and secure it tightly with screws.
6. Clamp the control wire with the cord clamp.
7. Install the clamp base with a screw.
8. Insert the power supply wire fully into the terminal block and secure it tightly with screws. Tightening torque: 1.2 N·m (0.12 kgf·m) Secure the earth line with the earth screw.
9. Clamp the power supply wire with the cord clamp.
10. Attach the terminal cover and the air inlet grille to the indoor unit.

CAUTION

- Be sure to refer to the wiring diagram attached inside the front panel.
- Check local electrical cords and also any specific wiring instructions and limitations.
- Do not catch the control wire when installing the clamp base.

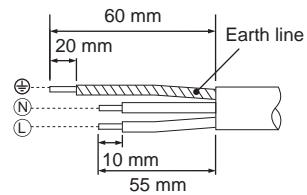
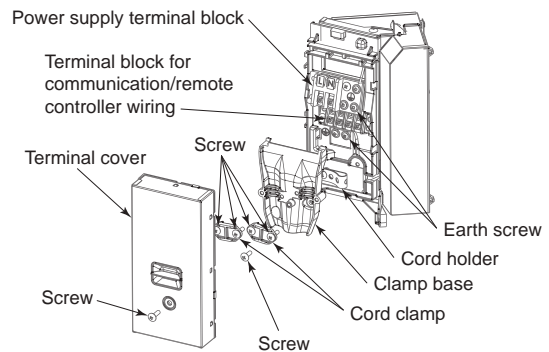

<Stripping length of the power supply wire>

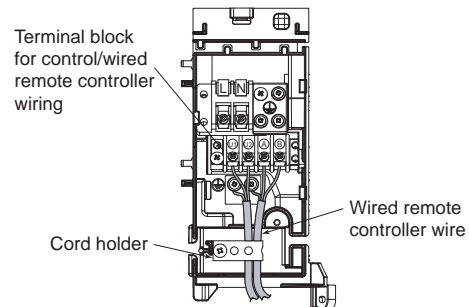
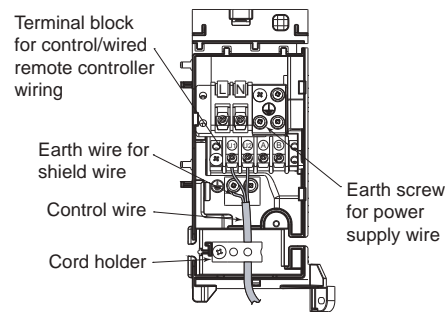

<Connecting wired remote controller wire>

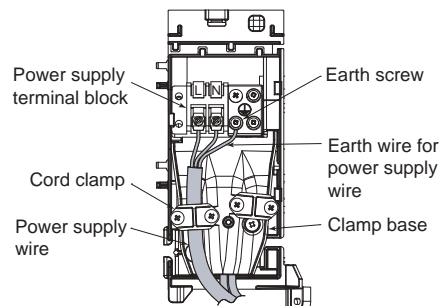

■ Wiring connection for flow selector unit

How to connect the wiring of flow selector unit

Connect the power supply wire and the communication wire supplied with the flow selector unit to the indoor unit.

1. Remove the air inlet grille.
Open the air inlet grille upward and pull it toward you.
2. Remove the terminal cover and the clamp base.
3. Insert the control wire fully into the control/wired remote controller terminal block and secure it tightly with screws.
4. Connect the control wire connector of the flow selector unit to the lead with a connector to the left of the control/wired remote controller terminal block.
5. Clamp the control wire and the control wire of the flow selector unit with the cord clamp.
6. Install the clamp base with a screw.
7. Insert the power supply wire fully into the terminal block and secure it tightly with screws.
Tightening torque: 1.2 N·m (0.12 kgf·m)
Secure the earth line with the earth screw.
8. Clamp the power supply wire with the cord clamp.
9. Insert the power supply wire fasten terminal of the flow selector unit into the power supply terminal.
10. Secure the earth line with the earth screw.
11. Clamp the power supply wire of the flow selector unit tight with the cord clamp.
12. Attach the terminal cover, the front panel and the air inlet grille to the indoor unit.

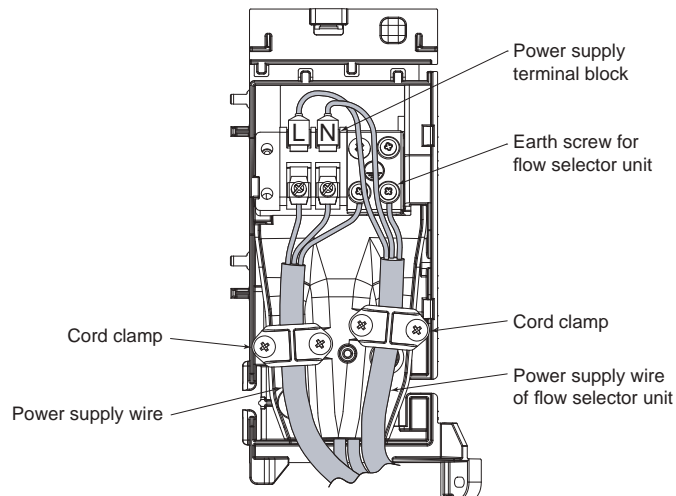

⚠ CAUTION

Confirm that every wires are stored in the electric parts box without getting caught before attaching the terminal cover.

11 APPLICABLE CONTROLS

REQUIREMENT

When the air conditioner is used for the first time, it will take some moments after the power has been turned on before the remote controller becomes available for operations: This is normal and is not indicative of trouble.

- Concerning the automatic addresses
(The automatic addresses are set up by performing operations on the outdoor interface circuit board.)
While the automatic addresses are being set up, no remote controller operations can be performed.
Setup takes up to 10 minutes (usually about 5 minutes).
- When the power is turned on after automatic address setup, it takes up to 10 minutes (usually about 3 minutes) for the outdoor unit to start operating after the power has been turned on.

Before the air conditioner was shipped from the factory, all units are set to [STANDARD] (factory default).

If necessary, change the indoor unit settings. The settings are changed by operating the wired remote controller.

- * The settings cannot be changed using only a wireless remote controller, simple remote controller or group control remote controller by itself so install a wired remote controller separately as well.

■ Applicable controls setup (settings at the site)

Remote controller model name: RBC-ASCU11-E

Basic procedure

Be sure to stop the air conditioner before making settings.

(Change the setup while the air conditioner is not working.)

⚠ CAUTION

Set only the Code No. shown in the following table: Do NOT set any other Code No.

If a Code No. not listed is set, it may not be possible to operate the air conditioner or other trouble with the product may result.

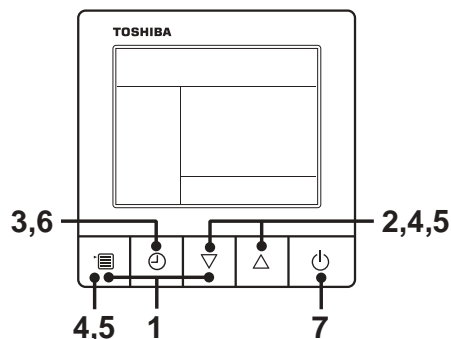

- 1 Push and hold menu button and [▽] setting button simultaneously for 10 seconds or more.

- After a while, the display flashes as shown in the figure. "ALL" is displayed as indoor unit numbers during initial communication immediately after the power has been turned on.

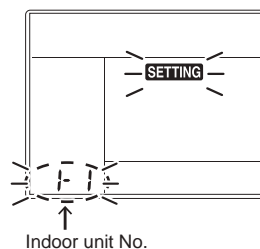

- 2 Each time [▽] [△] setting button is pushed, indoor unit numbers in the group control change cyclically. Select the indoor unit to change settings for.

- The fan of the selected indoor unit runs. The indoor unit can be confirmed for which to change settings.

- 3 Push OFF timer button to confirm the selected indoor unit.

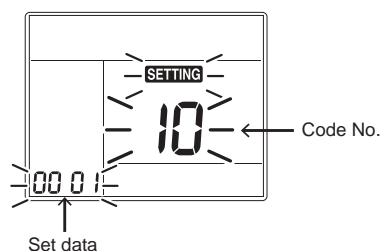

- 4 Push the menu button to make Code No. [**] flash. Change Code No. [**] with [▽] [△] setting button.

5 Push the menu button to make Set data [****] flash. Change Set data [****] with [▽] [△] setting button.

6 Push OFF timer button.
By doing so, the setup is completed.

- To change other settings of the selected indoor unit, repeat from Procedure **4**.

7 When all the settings have been completed, push ON/OFF button to determine the settings.

“SETTING” flashes and then the display content disappears and the air conditioner enters the normal stop mode. (The remote controller is unavailable while “SETTING” is flashing.)

- To change settings of another indoor unit, repeat from Procedure **1**.

■ Change of lighting time of filter sign

According to the installation condition, the lighting time of the filter sign (Notification of filter cleaning) can be changed.

Follow to the basic operation procedure (**1** → **2** → **3** → **4** → **5** → **6**).

- For the CODE No. in Procedure **4**, specify [01].
- For the [SET DATA] in Procedure **5**, select the SET DATA of filter sign lighting time from the following table.

SET DATA	Filter sign lighting time
0000	None
0001	150H (Factory setting)
0002	2500H
0003	5000H
0004	10000H

■ To secure better effect of heating

When it is difficult to obtain satisfactory heating due to installation place of the indoor unit or structure of the room, the detection temperature of heating can be raised. Also use a circulator, etc. to circulate heat air near the ceiling.

Follow to the basic operation procedure

(**1** → **2** → **3** → **4** → **5** → **6**).

- For the CODE No. in Procedure **4**, specify [06].
- For the SET DATA in Procedure **5**, select the SET DATA of shift value of detection temperature to be set up from the table below.

SET DATA	Detection temp shift value
0000	No shift
0001	+1°C
0002	+2°C (Factory setting)
0003	+3°C
0004	+4°C
0005	+5°C
0006	+6°C

■ Adjustment of air direction

1. Using the remote controller switch, change the up/down air direction by moving the horizontal louver.
2. Adjust the right/left air direction by bending the vertical grille inside of the air outlet port with hands.

REQUIREMENT

Do not touch the horizontal louver directly with hands; otherwise a trouble may be caused.

For handling of the horizontal louver, refer to "Owner's Manual" attached to the outdoor unit.

■ Group control

In a group control, a remote controller can control up to maximum 8 or 16 units. (Depending on the connecting unit type in page 31)

- The wired remote controller only can control a group control. The wireless remote controller is unavailable for this control.
- For cabling procedure and cables of the individual line (Identical refrigerant line) system, refer to "Electrical Connection" in this Manual.
- Cabling between indoor units in a group is performed in the following procedure.
Connect the indoor units by connecting the remote controller inter-unit cables from the remote controller terminal blocks (A, B) of the indoor unit connected with a remote controller to the remote controller terminal blocks (A, B) of the other indoor unit. (Non-polarity)
- For address setup, refer to the Installation Manual attached to the outdoor unit.

12 TEST RUN

■ Before test run

- Before turning on the power supply, carry out the following procedure.
 - 1) By using insulation tester (500VMΩ), check that resistance of 1MΩ or more exists between the terminal block L to N and the earth (grounding).
If resistance of less than 1MΩ is detected, do not run the unit.
 - 2) Check the valve of the outdoor unit being opened fully.
- To protect the compressor at activation time, leave power-ON for 12 hours or more before operating.
- Before starting a test run, set addresses by following the Installation Manual supplied with the outdoor unit.

◆ Requirements for turning thermostat OFF

Cooling operation

- When the outdoor/suction air temperature is lower than or equal to 19°C.
- When the outdoor/suction air temperature is lower than or equal to 3°C above the set temperature.

Heating operation

- When the outdoor/suction air temperature is lower than or equal to -10°C.
- When the outdoor/suction air temperature is higher than or equal to 15°C.
- When the outdoor/suction air temperature is higher than or equal to 3°C above the set temperature.

■ Execute a test run

- When a fan operation is to be performed for an individual indoor unit, turn off the power, short circuit CN72 on the circuit board, and then turn the power back on. (Set the operation mode to "fan" to operate the unit.) When the test run has been performed using this method, be sure to release the short circuit of CN72 after the test run is completed.

Operate the unit with the remote controller as usual.

For the procedure of the operation, refer to the attached Owner's Manual to the outdoor unit. A forced test run can be executed in the following procedure even if the operation stops by thermostat-OFF.

In order to prevent a serial operation, the forced test run is released after 60 minutes have passed and returns to the usual operation.

CAUTION

- Do not use the forced test run for cases other than the test run because it applies an excessive load to the devices.
-

Wired remote controller

Be sure to stop the air conditioner before making settings.

(Change the setup while the air conditioner is not working.)

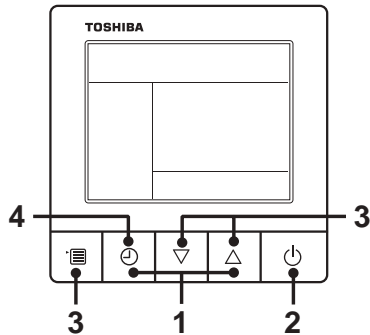

- 1 Push and hold OFF timer button and [△] setting button simultaneously for 10 seconds or more. [TEST] is displayed on the display part and the test run is permitted.

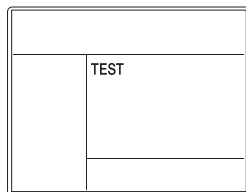

- 2 Push ON/OFF button.
- 3 Push menu button to select the operation mode. Select [Cool] or [Heat] with [▽] [△] setting button, and then push menu button (three times) again to determine the operation mode.
 - Do not run the air conditioner in a mode other than [Cool] or [Heat].
 - The temperature setting function does not work during test run.
 - The check code is displayed as usual.
- 4 After the test run, push OFF timer button to stop a test run.
([TEST] disappears on the display and the air conditioner enters the normal stop mode.)

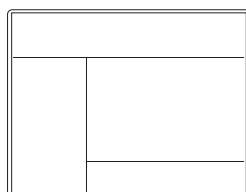

In case of wireless remote controller (Forced test operation is performed in a different way.)

REQUIREMENT

- For the operation procedure, be sure to follow the Owner's Manual.
- Finish the forced cooling operation in a short time because it applies excessive strength to the air conditioner.
- A test operation of forced heating is unavailable. Perform a test operation by heating operation using the switches of the remote controller.
However heating operation may be not carried out according to the temperature conditions.

- Check wiring/piping of indoor and outdoor units
1. When pushing [RESET] button for 10 seconds or more, "Pi!" sound is heard and the operation changes to a forced cooling operation. After approx. 3 minutes, a cooling operation starts forcibly. Check cool air starts blowing. If the operation does not start, check wiring again.
 2. To stop a test operation, push [RESET] button once again (Approx. 1 second). The louver closes and the operation stops.

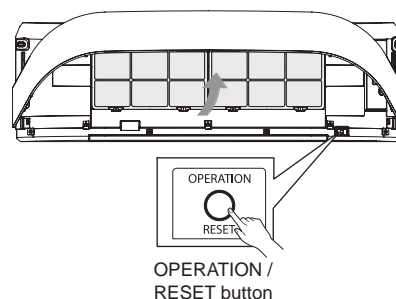

- Check transmission of remote controller
1. Push "START/STOP" button of the remote controller to check an operation can also start by the remote controller.
 - "Cooling" operation by the remote controller may be unavailable according to the temperature conditions. Check wiring/piping of the indoor and outdoor units in forced cooling operation.

13 TROUBLESHOOTING

A wired remote controller is necessary for this function. This function cannot be operate with a wireless remote controller.

■ Confirmation and check

If a problem occurs with the air conditioner, the OFF timer indicator alternately shows the check code and the indoor Unit No. in which the problem occurred.

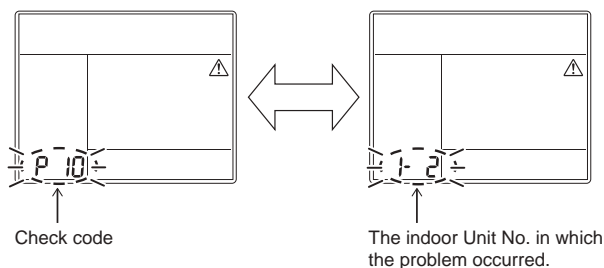

■ Troubleshooting history and confirmation

You can check the troubleshooting history with the following procedure if a problem occurs with the air conditioner.

(The troubleshooting history records up to 4 incidents.)

You can check it during operation or when operation is stopped.

- If you check the troubleshooting history during OFF timer operation, the OFF timer will be canceled.

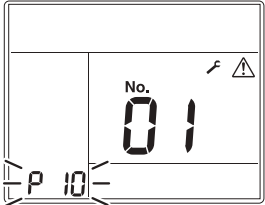
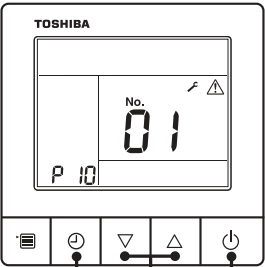
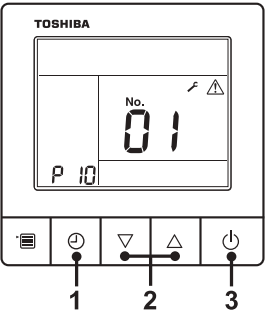
Procedure	Description of operation
<p>1</p>	<p>Push the OFF timer button for over 10 seconds and the indicators appear as an image indicating the troubleshooting history mode has been entered. If [Service check] is displayed, the mode enters in the troubleshooting history mode.</p> <ul style="list-style-type: none"> • [01: Order of troubleshooting history] appears in the temperature indicator. • The OFF timer indicator alternately shows the [check code] and the [indoor Unit No.] in which the problem occurred. 
<p>2</p>	<p>Each time the setting button is pushed, the recorded troubleshooting history is displayed in sequence. The troubleshooting history appears in order from [01] (newest) to [04] (oldest).</p> <p style="text-align: center;">⚠ CAUTION</p> <p>In the troubleshooting history mode, DO NOT push the Menu button for over 10 seconds, doing so deletes the entire troubleshooting history of the indoor unit.</p> 
<p>3</p>	<p>After you have finished checking, push the ON/OFF button to return to the regular mode.</p> <ul style="list-style-type: none"> • If the air conditioner is operating, it remains operated even after the ON/OFF button has been pushed. To stop its operation, push the ON/OFF button again. 

■ Check method

On the remote controller (Wired remote controller, Central control remote controller) and the interface P.C. Board of the outdoor unit (I/F), a check display LCD (Remote controller) or 7-segment display (on the outdoor interface P.C. Board) to display the operation is provided. Therefore the operation status can be known. Using this self-diagnosis function, a trouble or position with error of the air conditioner can be found as shown in the table below.

■ Check code list

The following list shows each check code. Find the check contents from the list according to part to be checked.

- In case of check from indoor remote controller: See “Wired remote controller display” in the list.
- In case of check from outdoor unit: See “Outdoor 7-segment display” in the list.
- In case of check from indoor unit with a wireless remote controller: See “Sensor block display of receiving unit” in the list.

○ : Lighting, ◻ : Flashing, ● : Goes off

ALT: Flashing is alternately when there are two flashing LED.

SIM: Simultaneous flashing when there are two flashing LED.

Inverter: Compressor / Fan inverter P.C. Board

I/F: Interface P.C. Board

Check code			Wireless remote controller				Check code name	Judging device
Wired remote controller display	Outdoor unit 7-segment display		Sensor block display of receiving unit					
		Auxiliary code	Operation	Timer	Ready	Flash		
E01	-	-	◻	●	●		Communication trouble between indoor unit and remote controller (Detected at remote controller side)	Remote controller
E02	-	-	◻	●	●		Remote controller transmission trouble	Remote controller
E03	-	-	◻	●	●		Communication trouble between indoor unit and remote controller (Detected at indoor unit side)	Indoor unit
E04	-	-	●	●	◻		Communication circuit trouble between indoor / outdoor unit (Detected at indoor unit side)	Indoor unit
E06	E06	No. of indoor units in which sensor has been normally received	●	●	◻		Decrease of No. of indoor units	I/F
-	E07	-	●	●	◻		Communication circuit trouble between indoor / outdoor unit (Detected at outdoor unit side)	I/F
E08	E08	Duplicated indoor unit addresses	◻	●	●		Duplicated indoor unit addresses	Indoor unit • I/F
E09	-	-	◻	●	●		Duplicated master remote controllers	Remote controller
E10	-	-	◻	●	●		Communication trouble between indoor unit MCU	Indoor unit
E11	-	-	◻	●	●		Communication trouble between Application control kit and Indoor unit	Indoor unit Application control kit
E12	E12	01: Indoor/Outdoor units communication 02: Outdoor/Outdoor units communication	◻	●	●		Automatic address start trouble	I/F
E15	E15	-	●	●	◻		No indoor unit during automatic addressing	I/F
E16	E16	00: Capacity over 01: No. of connected units	●	●	◻		Capacity over / No. of connected indoor units	I/F
E17	-	-	◻	●	●		Communication trouble between indoor unit and Flow Selector unit	Indoor unit
E18	-	-	◻	●	●		Communication trouble between header and follower units Indoor unit	Indoor unit
E19	E19	00: Header is not detected 02: Two or more header units	●	●	◻		Outdoor header units quantity trouble	I/F

Check code			Wireless remote controller				Check code name	Judging device
Wired remote controller display	Outdoor unit 7-segment display		Sensor block display of receiving unit					
		Auxiliary code	Operation	Timer	Ready	Flash		
E20	E20	01: Outdoor unit of other line connected 02: Indoor unit of other line connected	●	●	○		Other line connected during automatic address	I/F
E23	E23	—	●	●	○		Sending trouble in communication between outdoor units Trouble in number of heat storage units (trouble with reception)	I/F
E25	E25	—	●	●	○		Duplicated follower outdoor addresses	I/F
E26	E26	No. of outdoor units which received signal normally	●	●	○		Decrease of No. of connected outdoor units	I/F
E28	E28	Detected outdoor unit number	●	●	○		Follower outdoor unit trouble	I/F
E31	E31	*1 Inverter quantity information	●	●	○		Inverter communication trouble	I/F
F01	—	—	○	○	●	ALT	Indoor unit TCJ sensor trouble	Indoor unit
F02	—	—	○	○	●	ALT	Indoor unit TC2 sensor trouble	Indoor unit
F03	—	—	○	○	●	ALT	Indoor unit TC1 sensor trouble	Indoor unit
F04	F04	—	○	○	○	ALT	TD1 sensor trouble	I/F
F05	F05	—	○	○	○	ALT	TD2 sensor trouble	I/F
F06	F06	01: TE1 sensor 02: TE2 sensor 03: TE3 sensor	○	○	○	ALT	TE1, TE2 or TE3 sensor trouble	I/F
F07	F07	01: TL1 sensor 02: TL2 sensor 03: TL3 sensor	○	○	○	ALT	TL1, TL2 or TL3 sensor trouble	I/F
F08	F08	—	○	○	○	ALT	TO sensor trouble	I/F
F09	F09	01: TG1 sensor 02: TG2 sensor 03: TG3 sensor	○	○	○	ALT	TG1, TG2 or TG3 sensor trouble	I/F
F10	—	—	○	○	●	ALT	Indoor unit TA sensor trouble	Indoor unit
F11	—	—	○	○	●	ALT	TF sensor trouble	Indoor unit
F12	F12	01: TS1 sensor 03: TS3 sensor 04: TS3 sensor disconnect	○	○	○	ALT	TS1 or TS3 sensor trouble	I/F
F13	F13	1* : Comp. 1 side 2* : Comp. 2 side	○	○	○	ALT	TH sensor trouble	Inverter
F15	F15	—	○	○	○	ALT	Outdoor unit temp. sensor miswiring (TE, TL)	I/F
F16	F16	—	○	○	○	ALT	Outdoor unit pressure sensor miswiring (Pd, Ps)	I/F
F22	F22	—	○	○	○	ALT	TD3 sensor trouble	I/F
F23	F23	—	○	○	○	ALT	Ps sensor trouble	I/F
F24	F24	—	○	○	○	ALT	Pd sensor trouble	I/F
F29	—	—	○	○	●	SIM	Indoor unit other trouble	Indoor unit
F30	F30	—	○	○	○	SIM	Occupancy sensor trouble	Indoor unit
F31	F31	—	○	○	○	SIM	Indoor unit EEPROM trouble	I/F
H01	H01	1* : Comp. 1 side 2* : Comp. 2 side	●	○	●		Compressor break down	Inverter
H02	H02	1* : Comp. 1 side 2* : Comp. 2 side	●	○	●		Compressor trouble (lock)	Inverter
H03	H03	1* : Comp. 1 side 2* : Comp. 2 side	●	○	●		Current detect circuit system trouble	Inverter
H04	H04	—	●	○	●		Comp. 1 case thermostat operation	I/F
H05	H05	—	●	○	●		TD1 sensor miswiring	I/F
H06	H06	—	●	○	●		Low pressure protective operation	I/F
H07	H07	—	●	○	●		Oil level down detective protection	I/F
H08	H08	01: TK1 sensor trouble 02: TK2 sensor trouble 03: TK3 sensor trouble 04: TK4 sensor trouble 05: TK5 sensor trouble	●	○	●		Oil level detective temp. sensor trouble	I/F

Check code			Wireless remote controller				Check code name	Judging device
Wired remote controller display	Outdoor unit 7-segment display		Sensor block display of receiving unit					
		Auxiliary code	Operation	Timer	Ready	Flash		
H14	H14	—	●	□	●		Comp. 2 case thermostat operation	I/F
H15	H15	—	●	□	●		TD2 sensor miswiring	I/F
H16	H16	01: TK1 oil circuit system trouble 02: TK2 oil circuit system trouble 03: TK3 oil circuit system trouble 04: TK4 oil circuit system trouble 05: TK5 oil circuit system trouble	●	□	●		Oil level detective circuit trouble	I/F
H17	H17	1* : Compressor 1 side 2* : Compressor 2 side	●	□	●		Compressor trouble (Step out)	I/F
H25	H25	—	●	□	●		TD3 sensor miswiring	I/F
J02	—	—	●	□	□	SIM	Communication trouble between control boards in Flow Selector unit	Indoor unit
J03	—	—	●	□	□	SIM	Duplicated Flow Selector unit addresses	Indoor unit
J10	J10	Detected indoor unit address	●	□	□	SIM	Flow Selector unit overflow trouble	Indoor unit
J11	—	—	●	□	□	SIM	Flow Selector unit temperature sensor (TCS) trouble	
J29	—	—	●	□	□	SIM	Refrigerant leak detection sensor trouble	Indoor unit
J30	J30	Detected indoor unit address * Not displayed depending on the DN code (I.DN) setting	●	□	□	SIM	Refrigerant leak detection	Indoor unit
J31	—	—	●	□	□	SIM	Refrigerant leak detection sensor exceeding its life of the product	Indoor unit
L02	L02	Detected indoor unit address	□	●	□	SIM	Model mismatch of indoor and outdoor unit Indoor unit incompatible with A2L (R32) refrigerant	I/F
L03	—	—	□	●	□	SIM	Indoor unit centre unit duplicated	Indoor unit
L04	L04	—	□	○	□	SIM	Outdoor unit line address duplicated	I/F
L05	—	—	□	●	□	SIM	Duplicated indoor units with priority (Displayed in indoor unit with priority)	I/F
L06	L06	No. of indoor units with priority	□	●	□	SIM	Duplicated indoor units with priority (Displayed in unit other than indoor unit with priority)	I/F
L07	—	—	□	●	□	SIM	Group line in individual indoor unit	Indoor unit
L08	L08	—	□	●	□	SIM	Indoor unit group/Address unset	Indoor unit, I/F
L09	—	—	□	●	□	SIM	Indoor unit capacity unset	Indoor unit
L10	L10	—	□	○	□	SIM	Outdoor unit capacity unset	I/F
L11	L11	Detected indoor unit address	□	○	□	SIM	Flow Selector unit not connected	I/F
L12	L12	01: Flow Selector unit installation trouble	□	○	□	SIM	Flow Selector unit system trouble	I/F
L13	L13	Detected indoor unit address	□	○	□	SIM	Safety device setting unmatch	I/F
L14	L14	Detected indoor unit address	□	○	□	SIM	Safety device nonconformity	I/F
L17	L17	—	□	○	□	SIM	Outdoor unit type mismatch trouble	I/F
L18	L18	Detected indoor unit address	□	○	□	SIM	Flow Selector unit trouble	I/F
L20	—	—	□	○	□	SIM	Duplicated central control addresses	Indoor unit
L22	—	—	□	○	□	SIM	There is a DX-kit (heat source capacity command) non-compliant machine in the group (DDC control, TA control and TF control are mixed)	Indoor unit
L24	L24	01: Duplication of Flow Selector unit address 02: Indoor unit operation mode priority setting	□	○	□	SIM	Flow Selector unit setting trouble	I/F
L28	L28	—	□	○	□	SIM	Too many outdoor units connected	I/F
L29	L29	*1 Inverter quantity information	□	○	□	SIM	No. of inverter trouble	I/F
L30	L30	Detected indoor unit address	□	○	□	SIM	Indoor unit outside interlock	Indoor unit
—	L31	—	—	—	—	—	Extended I/C trouble	I/F

Check code			Wireless remote controller				Check code name	Judging device
Wired remote controller display	Outdoor unit 7-segment display		Sensor block display of receiving unit					
		Auxiliary code	Operation	Timer	Ready	Flash		
P01	–	–	●	□	□	ALT	Indoor fan motor trouble	Indoor unit
P03	P03	–	□	●	□	ALT	Discharge temp. TD1 trouble	I/F
P04	P04	1* : Comp. 1 side 2* : Comp. 2 side	□	●	□	ALT	High-pressure SW system operation	Inverter
P05	P05	1* : Comp. 1 side 2* : Comp. 2 side	□	●	□	ALT	Phase missing detection/Power failure detection Inverter DC voltage trouble (comp.)	I/F
P07	P07	1* : Comp. 1 side 2* : Comp. 2 side ----- 04: Heat sink	□	●	□	ALT	Heat sink overheat trouble ----- Heat sink dew condensation trouble	Inverter, I/F
P10	P10	Detected indoor unit address	●	□	□	ALT	Indoor unit overflow trouble	Indoor unit
P11	P11	–	●	□	□	ALT	Outdoor heat exchanger freezing trouble	I/F
P12	–	–	●	□	□	ALT	Indoor unit fan motor trouble	Indoor unit
P13	P13	–	●	□	□	ALT	Outdoor liquid back detection trouble	I/F
P15	P15	01: TS condition 02: TD condition	□	●	□	ALT	Gas leak detection	I/F
P16	P16	01: PMV5 02: PMV6 03: SV7	□	●	□	ALT	Injection circuit trouble	I/F
P17	P17	–	□	●	□	ALT	Discharge temp. TD2 trouble	I/F
P18	P18	–	□	●	□	ALT	Discharge temp. TD3 trouble	I/F
P19	P19	0#: 4-way valves 1#: 4-way valve1 2#: 4-way valve2 * Put in outdoor unit No. in [#] mark.	□	●	□	ALT	4-way valve inverse trouble	I/F
P20	P20	–	□	●	□	ALT	High-pressure protective operation	I/F
P22	P22	1* : Compressor 1 side 2* : Compressor 2 side	□	●	□	ALT	Outdoor unit fan inverter trouble	Inverter
P26	P26	1* : Comp. 1 side 2* : Comp. 2 side	□	●	□	ALT	IPM short protection trouble	Inverter
P29	P29	1* : Comp. 1 side 2* : Comp. 2 side	□	●	□	ALT	Comp. position detective circuit system trouble	Inverter
P31	–	–	□	●	□	ALT	Other indoor unit trouble (Group follower indoor unit trouble)	Indoor unit

- For details about check codes determined with an Interface P.C. Board or an Inverter P.C. Board, refer to the Installation Manual of the outdoor unit.

***1 Inverter quantity information**

(Super Modular Multi System e and u series (SMMS-e, SMMS-u, SHRM-A))

No.	Comp. Inverter		Fan Inverter		Trouble
	1	2	1	2	
01	○				Comp. 1
02		○			Comp. 2
03	○	○			Comp. 1 + Comp. 2
08			○		Fan 1
09	○		○		Comp. 1 + Fan 1
0A		○	○		Comp. 2 + Fan 1
0B	○	○	○		Comp. 1 + Comp. 2 + Fan 1
10				○	Fan 2
11	○			○	Comp. 1 + Fan 2
12		○		○	Comp. 2 + Fan 2
13	○	○		○	Comp. 1 + Comp. 2 + Fan 2
18			○	○	Fan 1 + Fan 2
19	○		○	○	Comp. 1 + Fan 1 + Fan 2
1A		○	○	○	Comp. 2 + Fan 1 + Fan 2
1B	○	○	○	○	All

○ : Inverter trouble

Trouble detected by central control device

Central control device indication	Check code		Wireless remote controller				Check code name	Judging device
	Outdoor unit 7-segment display		Sensor block display of receiving unit					
		Auxiliary code	Operation	Timer	Ready	Flash		
C05	-	-					Sending trouble in central control device	Central control device
C06	-	-					Receiving trouble in central control device	Central control device
C12	-	-					Batch alarm of general-purpose equipment control interface	General-purpose equipment I/F
P30 (L20)	Differs according to trouble contents of unit with occurrence of alarm						Group control follower unit trouble	Central control device
	-	-	(L20 is displayed.)				<ul style="list-style-type: none"> • Duplication addresses of indoor units in central control device • With the combination of air conditioning system, the indoor unit may detect the check code of L20 	
S01	-	-					Receiving trouble in central control device	Central control device

14 SPECIFICATIONS

Model	Sound pressure level (dBA)		Weight (kg)
	Cooling	Heating	
MMK-UP0051DHPL-E(TR)	*	*	12
MMK-UP0071DHPL-E(TR)	*	*	12
MMK-UP0091DHPL-E(TR)	*	*	12
MMK-UP0121DHPL-E(TR)	*	*	12
MMK-UP0151DHPL-E(TR)	*	*	12
MMK-UP0181DHPL-E(TR)	*	*	12

* Under 70 dBA

15 NOTICE CODE

- Notice code is a function only in TC2U-Link communication.
- When the outdoor or indoor unit detects its conditions requiring caution or maintenance, this function notices you to check your units with the spanner mark (Notice code mark) on the wired remote controller or central controller display.
- Even while the notice code mark is displayed, the air conditioner can operate normally.
- A maximum of 5 notice codes can be issued simultaneously in one system (line).

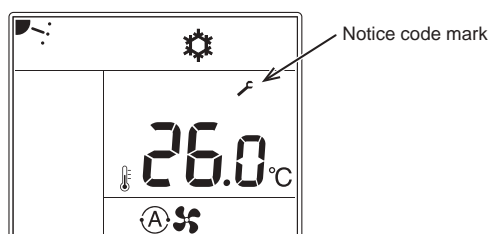

■ How to check Notice code No.

- 1** Stop the operation of the air conditioner and push the Menu button and OFF timer button at the same time for 10 seconds or more.
- 2** The unit number of the indoor unit is displayed at the bottom left of the screen. Change it with the [▽] [△] setting button and push the OFF timer button to confirm.
- 3** The history number is displayed in the center of the screen, and the Notice code No. is displayed in the lower left. [▽] [△] You can switch the history with the setting button (a maximum of 5 notice codes).
- 4** Push the ON / OFF button to return to the operation stop screen.

■ Notice code list

Notice code No.	Item	Content
203	Flow Selector unit battery dead	The battery kit connected to the Flow Selector unit has reached the end of its life.
204	Leak detector life advance display	The leak detector will soon reach the end of its life.

Declaration of Conformity

Manufacturer: Toshiba Carrier (Thailand) Co., Ltd.
144 / 9 Moo 5, Bangkadi Industrial Park, Tivanon road, Tambol Bangkadi,
Amphur Muang, Pathumthani 12000, Thailand

TCF holder: TOSHIBA CARRIER EUROPE S.A.S
Route de Thil 01120 Montluel FRANCE

Hereby declares that the machinery described below:

Generic Denomination: Air Conditioner

Model / type: MMK-UP0051DHPL-E(TR), MMK-UP0121DHPL-E(TR)
MMK-UP0071DHPL-E(TR), MMK-UP0151DHPL-E(TR)
MMK-UP0091DHPL-E(TR), MMK-UP0181DHPL-E(TR)

Commercial name: Super Modular Multi System Air Conditioner
Super Heat Recovery Multi System Air Conditioner
Mini-Super Modular Multi System Air Conditioner (MiNi-SMMS series)

Complies with the provisions of the Machinery Directive (Directive 2006/42/EC) and the regulations transposing into national law

Name: Kazunari Watanabe
Position: GM, Quality Assurance Dept.
Date: 15 March, 2023
Place Issued: Thailand

NOTE

This declaration becomes invalid if technical or operational modifications are introduced without the manufacturer's consent.

Declaration of Conformity

Manufacturer: Toshiba Carrier (Thailand) Co., Ltd.
144 / 9 Moo 5, Bangkadi Industrial Park, Tivanon road, Tambol Bangkadi,
Amphur Muang, Pathumthani 12000, Thailand

TCF holder: TOSHIBA CARRIER UK LTD.
Porsham Close Belliver Industrial Estate Roborough Plymouth Devon
PL6 7DB United Kingdom

Hereby declares that the machinery described below:

Generic Denomination: Air Conditioner

Model / type: MMK-UP0051DHPL-E(TR), MMK-UP0121DHPL-E(TR)
MMK-UP0071DHPL-E(TR), MMK-UP0151DHPL-E(TR)
MMK-UP0091DHPL-E(TR), MMK-UP0181DHPL-E(TR)

Commercial name: Super Modular Multi System Air Conditioner
Super Heat Recovery Multi System Air Conditioner
Mini-Super Modular Multi System Air Conditioner (MiNi-SMMS series)

Complies with the provisions of the Supply of Machinery (Safety) Regulations 2008

Name: Kazunari Watanabe
Position: GM, Quality Assurance Dept.
Date: 15 March, 2023
Place Issued: Thailand

NOTE

This declaration becomes invalid if technical or operational modifications are introduced without the manufacturer's consent.

16 APPENDIX

Work instructions

The existing R22 and R410A piping can be reused for inverter R32 product installations.

WARNING

Confirming the existence of scratches or dents on the existing pipes and confirming the reliability of the pipe strength are conventionally referred to the local site. If the specified conditions can be cleared, it is possible to update existing R22 and R410A pipes to those for R32 models.

Basic conditions needed to reuse existing pipes

Check and observe the presence of three conditions in the refrigerant piping works.

1. **Dry** (There is no moisture inside of the pipes.)
2. **Clean** (There is no dust inside of the pipes.)
3. **Tight** (There are no refrigerant leaks.)

Restrictions for use of existing pipes

In the following cases, the existing pipes should not be reused as they are. Clean the existing pipes or exchange them with new pipes.

1. When a scratch or dent is heavy, be sure to use new pipes for the refrigerant piping works.
2. When the existing pipe thickness is thinner than the specified "Pipe diameter and thickness," be sure to use new pipes for the refrigerant piping works.
 - The operating pressure of refrigerant is high. If there is a scratch or dent on the pipe or a thinner pipe is used, the pressure strength may be inadequate, which may cause the pipe to break in the worst case.

* Pipe diameter and thickness (mm)

Pipe outer diameter		Ø6.4	Ø9.5	Ø12.7	Ø15.9
Thickness	R32, R410A	0.8	0.8	0.8	1.0
	R22				

3. When the outdoor unit was left with the pipes disconnected, or the gas leaked from the pipes and the pipes were not repaired and refilled.
 - There is the possibility of rain water or air, including moisture, entering the pipe.
4. When refrigerant cannot be recovered using a refrigerant recovery unit.
 - There is the possibility that a large quantity of dirty oil or moisture remains inside the pipes.

5. When a commercially available dryer is attached to the existing pipes.
 - There is the possibility that copper green rust has been generated.
6. When the existing air conditioner is removed after refrigerant has been recovered. Check if the oil is judged to be clearly different from normal oil.
 - The refrigerator oil is copper rust green in color:
 - There is the possibility that moisture has mixed with the oil and rust has been generated inside the pipe.
 - There is discolored oil, a large quantity of residue, or a bad smell.
 - A large quantity of shiny metal dust or other wear residue can be seen in the refrigerant oil.
7. When the air conditioner has a history of the compressor failing and being replaced.
 - When discolored oil, a large quantity of residue, shiny metal dust, or other wear residue or mixture of foreign matter is observed, trouble will occur.
8. When temporary installation and removal of the air conditioner are repeated such as when leased etc.
9. If the type of refrigerator oil of the existing air conditioner is other than the following oil (Mineral oil), Suniso, Freol-S, MS (Synthetic oil), alkyl benzene (HAB, Barrel-freeze), ester series, PVE only of ether series.
 - The winding-insulation of the compressor may deteriorate.

NOTE

The above descriptions are results have been confirmed by our company and represent our views on our air conditioners, but do not guarantee the use of the existing pipes of air conditioners that have adopted R32, R410A in other companies.

Curing of pipes

When removing and opening the indoor or outdoor unit for a long time, cure the pipes as follows:

- Otherwise rust may be generated when moisture or foreign matter due to condensation enters the pipes.
- The rust cannot be removed by cleaning, and new pipes are necessary.

Placement location	Term	Curing manner
Outdoors	1 month or more	Pinching or taping
	Less than 1 month	
Indoors	Every time	

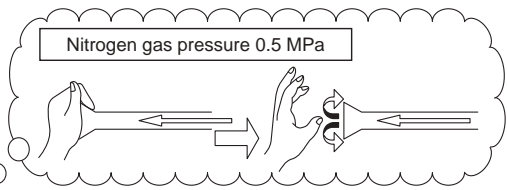
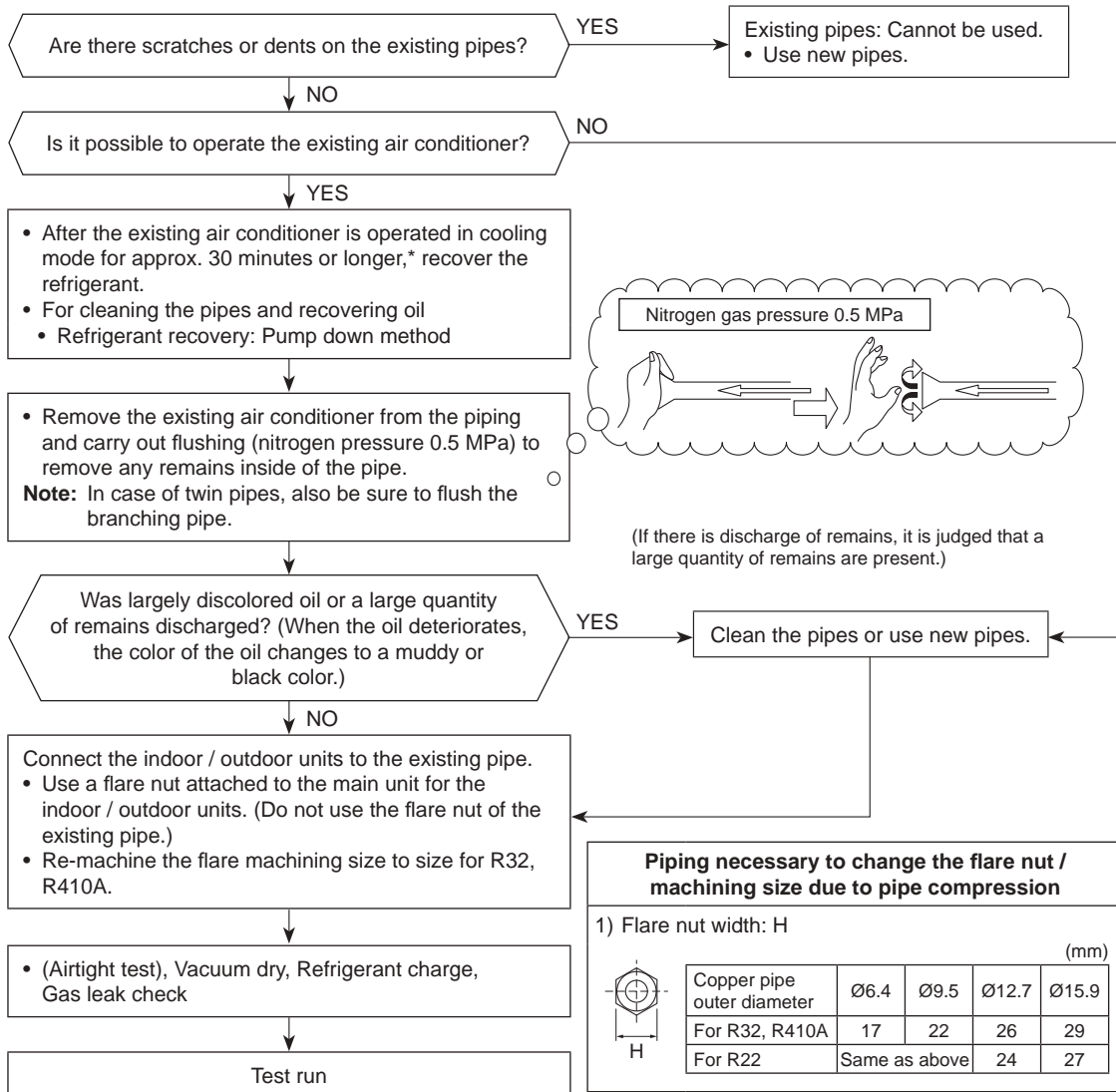

(If there is discharge of remains, it is judged that a large quantity of remains are present.)

Piping necessary to change the flare nut / machining size due to pipe compression

1) Flare nut width: H (mm)

Copper pipe outer diameter	Ø6.4	Ø9.5	Ø12.7	Ø15.9
For R32, R410A	17	22	26	29
For R22	Same as above	24	27	

2) Flare machining size: A (mm)

Copper pipe outer diameter	Ø6.4	Ø9.5	Ø12.7	Ø15.9
For R32, R410A	9.1	13.2	16.6	19.7
For R22	9.0	13.0	16.2	19.4

Becomes a little larger for R32, R410A

Do not apply refrigerator oil to the flare surface.

WARNINGS ON REFRIGERANT LEAKAGE

Check of Concentration Limit

The room in which the air conditioner is to be installed requires a design that in the event of refrigerant gas leaking out, its concentration will not exceed a set limit.

The refrigerant R32 or R410A which is used in the air conditioner is safe, without the toxicity or combustibility of ammonia, and is not restricted by laws to be imposed which protect the ozone layer. However, since it contains more than air, it poses the risk of suffocation if its concentration should rise excessively. Suffocation from leakage of R32 or R410A is almost non-existent. With the recent increase in the number of high concentration buildings, however, the installation of multi air conditioner systems is on the increase because of the need for effective use of floor space, individual control, energy conservation by curtailing heat and carrying power etc.

Most importantly, the multi air conditioner system is able to replenish a large amount of refrigerant compared with conventional individual air conditioners. If a single unit of the multi conditioner system is to be installed in a small room, select a suitable model and installation procedure so that if the refrigerant accidentally leaks out, its concentration does not reach the limit (and in the event of an emergency, measures can be made before injury can occur).

In a room where the concentration may exceed the limit, create an opening with adjacent rooms, or install mechanical ventilation combined with a gas leak detection device.

The concentration is as given below.

$$\frac{\text{Total amount of refrigerant (kg)}}{\text{Min. volume of the indoor unit installed room (m}^3\text{)}} \leq \text{Concentration limit (kg/m}^3\text{)}$$

The concentration limit of R32 or R410A which is used in multi air conditioners is 0.3 kg/m³.

▼ NOTE 1

If there are 2 or more refrigerating systems in a single refrigerating device, the amounts of refrigerant should be as charged in each independent device.

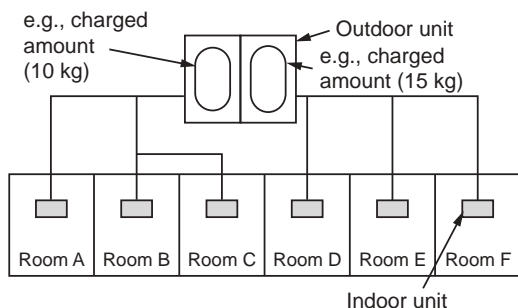

For the amount of charge in this example:

The possible amount of leaked refrigerant gas in rooms A, B and C is 10 kg.

The possible amount of leaked refrigerant gas in rooms D, E and F is 15 kg.

▼ NOTE 2

The standards for minimum room volume are as follows.

(1) No partition (shaded portion)

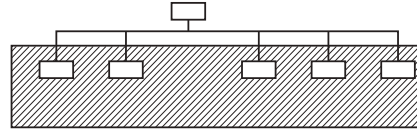

(2) When there is an effective opening with the adjacent room for ventilation of leaking refrigerant gas (opening without a door, or an opening 0.15% or larger than the respective floor spaces at the top or bottom of the door).

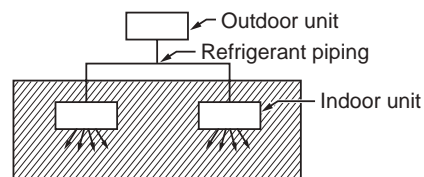

(3) If an indoor unit is installed in each partitioned room and the refrigerant piping is interconnected, the smallest room of course becomes the object. But when a mechanical ventilation is installed interlocked with a gas leakage detector in the smallest room where the density limit is exceeded, the volume of the next smallest room becomes the object.

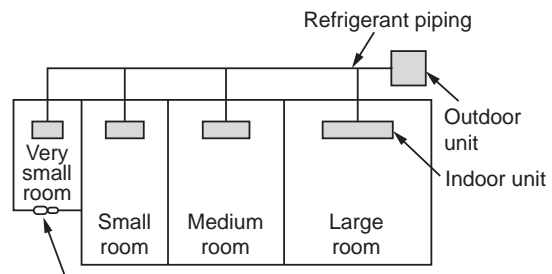

Mechanical ventilation device - Gas leak detector

▼ NOTE 3

The minimum indoor floor area compared with the amount of refrigerant is roughly as follows: (When the ceiling is 2.7 m high)

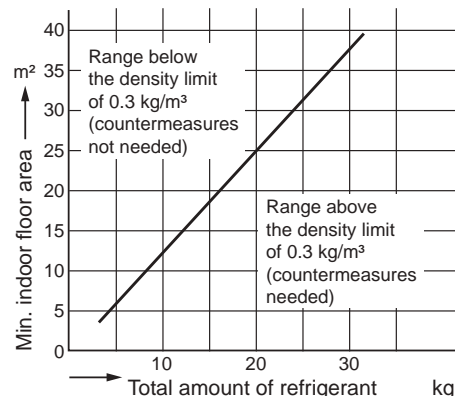

CONFIRMATION OF INDOOR UNIT SETUP

Prior to delivery to the customer, check the address and setup of the indoor unit, which has been installed in this time and fill the check sheet (Table below). Data of four units can be entered in this check sheet. Copy this sheet according to the No. of the indoor units. If the installed system is a group control system, use this sheet by entering each line system into each Installation Manual attached to the other indoor units.

REQUIREMENT

This check sheet is required for maintenance after installation. Be sure to fill this sheet and then pass this Installation Manual to the customers.

Indoor unit setup check sheet





Indoor unit			Indoor unit			Indoor unit			Indoor unit		
Room name			Room name			Room name			Room name		
Model			Model			Model			Model		
Check indoor unit address. (For check method, refer to Applicable controls in this sheet.) * In case of a single system, it is unnecessary to enter the indoor address. (CODE No.: Line [12], Indoor [13], Group [14], Central control [03])											
Line	Indoor	Group	Line	Indoor	Group	Line	Indoor	Group	Line	Indoor	Group
Central control address			Central control address			Central control address			Central control address		
Various setup			Various setup			Various setup			Various setup		
Have you changed high ceiling setup? If not, fill check mark [x] in [NO CHANGE], and fill check mark [x] in [ITEM] if changed, respectively. (For check method, refer to Applicable controls in this sheet.) * In case of replacement of short plugs on indoor microcomputer P.C. Board, setup is automatically changed.											
High ceiling setup (CODE NO. [5d]) <input type="checkbox"/> NO CHANGE <input type="checkbox"/> STANDARD [0000] <input type="checkbox"/> HIGH CEILING 1 [0001] <input type="checkbox"/> HIGH CEILING 3 [0003]			High ceiling setup (CODE NO. [5d]) <input type="checkbox"/> NO CHANGE <input type="checkbox"/> STANDARD [0000] <input type="checkbox"/> HIGH CEILING 1 [0001] <input type="checkbox"/> HIGH CEILING 3 [0003]			High ceiling setup (CODE NO. [5d]) <input type="checkbox"/> NO CHANGE <input type="checkbox"/> STANDARD [0000] <input type="checkbox"/> HIGH CEILING 1 [0001] <input type="checkbox"/> HIGH CEILING 3 [0003]			High ceiling setup (CODE NO. [5d]) <input type="checkbox"/> NO CHANGE <input type="checkbox"/> STANDARD [0000] <input type="checkbox"/> HIGH CEILING 1 [0001] <input type="checkbox"/> HIGH CEILING 3 [0003]		
Have you changed lighting time of filter sign? If not, fill check mark [x] in [NO CHANGE], and fill check mark [x] in [ITEM] if changed, respectively. (For check method, refer to Applicable controls in this sheet.)											
Filter sign lighting time (CODE NO. [01]) <input type="checkbox"/> NO CHANGE <input type="checkbox"/> NONE [0000] <input type="checkbox"/> 150H [0001] <input type="checkbox"/> 2500H [0002] <input type="checkbox"/> 5000H [0003] <input type="checkbox"/> 10000H [0004]			Filter sign lighting time (CODE NO. [01]) <input type="checkbox"/> NO CHANGE <input type="checkbox"/> NONE [0000] <input type="checkbox"/> 150H [0001] <input type="checkbox"/> 2500H [0002] <input type="checkbox"/> 5000H [0003] <input type="checkbox"/> 10000H [0004]			Filter sign lighting time (CODE NO. [01]) <input type="checkbox"/> NO CHANGE <input type="checkbox"/> NONE [0000] <input type="checkbox"/> 150H [0001] <input type="checkbox"/> 2500H [0002] <input type="checkbox"/> 5000H [0003] <input type="checkbox"/> 10000H [0004]			Filter sign lighting time (CODE NO. [01]) <input type="checkbox"/> NO CHANGE <input type="checkbox"/> NONE [0000] <input type="checkbox"/> 150H [0001] <input type="checkbox"/> 2500H [0002] <input type="checkbox"/> 5000H [0003] <input type="checkbox"/> 10000H [0004]		
Have you changed detected temp. shift value? If not, fill check mark [x] in [NO CHANGE], and fill check mark [x] in [ITEM] if changed, respectively. (For check method, refer to Applicable control in this sheet.)											
Detected temp. shift value setup (CODE No. [06]) <input type="checkbox"/> NO CHANGE <input type="checkbox"/> NO SHIFT [0000] <input type="checkbox"/> +1°C [0001] <input type="checkbox"/> +2°C [0002] <input type="checkbox"/> +3°C [0003] <input type="checkbox"/> +4°C [0004] <input type="checkbox"/> +5°C [0005] <input type="checkbox"/> +6°C [0006]			Detected temp. shift value setup (CODE No. [06]) <input type="checkbox"/> NO CHANGE <input type="checkbox"/> NO SHIFT [0000] <input type="checkbox"/> +1°C [0001] <input type="checkbox"/> +2°C [0002] <input type="checkbox"/> +3°C [0003] <input type="checkbox"/> +4°C [0004] <input type="checkbox"/> +5°C [0005] <input type="checkbox"/> +6°C [0006]			Detected temp. shift value setup (CODE No. [06]) <input type="checkbox"/> NO CHANGE <input type="checkbox"/> NO SHIFT [0000] <input type="checkbox"/> +1°C [0001] <input type="checkbox"/> +2°C [0002] <input type="checkbox"/> +3°C [0003] <input type="checkbox"/> +4°C [0004] <input type="checkbox"/> +5°C [0005] <input type="checkbox"/> +6°C [0006]			Detected temp. shift value setup (CODE No. [06]) <input type="checkbox"/> NO CHANGE <input type="checkbox"/> NO SHIFT [0000] <input type="checkbox"/> +1°C [0001] <input type="checkbox"/> +2°C [0002] <input type="checkbox"/> +3°C [0003] <input type="checkbox"/> +4°C [0004] <input type="checkbox"/> +5°C [0005] <input type="checkbox"/> +6°C [0006]		
Incorporation of parts sold separately			Incorporation of parts sold separately			Incorporation of parts sold separately			Incorporation of parts sold separately		
Have you incorporated the following parts sold separately? If incorporated, fill check mark [x] in each [ITEM]. (When incorporating, the setup change is necessary in some cases. For setup change method, refer to Installation Manual attached to each part sold separately.)											
Panel <input type="checkbox"/> Standard panel			Panel <input type="checkbox"/> Standard panel			Panel <input type="checkbox"/> Standard panel			Panel <input type="checkbox"/> Standard panel		
Filter <input type="checkbox"/> Super long life filter			Filter <input type="checkbox"/> Super long life filter			Filter <input type="checkbox"/> Super long life filter			Filter <input type="checkbox"/> Super long life filter		
<input type="checkbox"/> Others ()			<input type="checkbox"/> Others ()			<input type="checkbox"/> Others ()			<input type="checkbox"/> Others ()		
<input type="checkbox"/> Others ()			<input type="checkbox"/> Others ()			<input type="checkbox"/> Others ()			<input type="checkbox"/> Others ()		



11. HOW TO REPLACE THE MAIN PARTS





WARNING

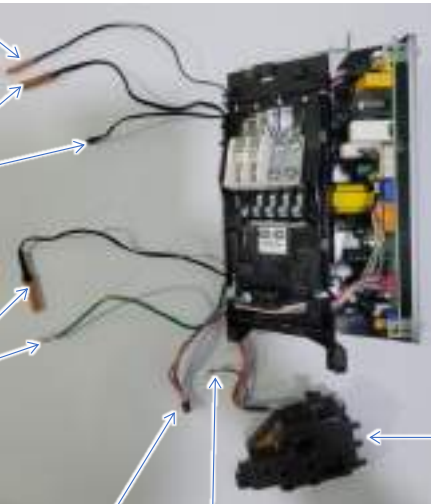

- Since high voltages pass through the electrical parts, turn off the power without fail before proceeding with the repairs. Electric shocks may occur if the power plug is not disconnected.
- After the repairs have been completed (after the front panel and cabinet have been installed), perform a test run, and check for smoking, unusual sounds and other abnormalities.
If this check is omitted, a fire and/or electric shocks may occur.
Before proceeding with the test run, install the front panel and cabinet.
- Ensure that the following steps are taken when doing repairs on the refrigerating cycle.
 1. Do not allow any naked flames in the surrounding area.
If a gas stove or other appliance is being used, extinguish the flames before proceeding.
If the flames are not extinguished, they may ignite any oil mixed with the refrigerant gas.
 2. Do not use welding equipment in an airtight room.
Carbon monoxide poisoning may result if the room is not properly ventilated.
 3. Do not bring welding equipment near flammable objects.
Flames from the equipment may cause the flammable objects to catch fire.
- **If keeping the power on is absolutely unavoidable while doing a job such as inspecting the cir-cuitry, wear rubber gloves to avoid contact with the live parts.**
Electric shocks may be received if the live parts are touched.
High-voltage circuits are contained inside this unit.
Proceed very carefully when conducting checks since directly touching the parts on the control circuit board may result in electric shocks.

Indoor unit

No.	Part name	Procedures	Remarks
①	Air inlet grille	1) Stop operation of the air conditioner and turn off its main power supply. 2) Open the air inlet grille and push the arm toward the outside, and remove the grille. <div style="text-align: center; margin-top: 10px;">  </div>	
②	Air filters	1) Follow to the procedure in the item ①. <div style="text-align: center; margin-top: 10px;">  </div> 2) Push up the rib air filter and remove the air filters left and right from the front panel.	

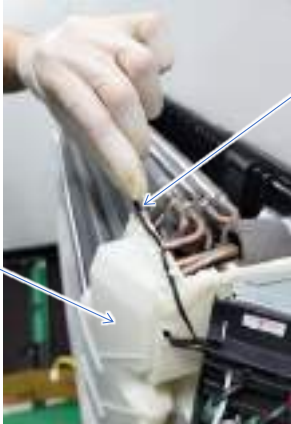
No.	Part name	Procedures	Remarks
3	Front panel	<p>1) Stop operation of the air conditioner and turn off its main power supply.</p> <p>2) Remove screw holding the terminal cover</p>  <p style="text-align: center;">Front panel</p>  <p style="text-align: center;">Terminal cover</p> <p>3) Remove the fixing screw (2 pcs) on front panel.</p>  <p style="text-align: center;">Screw</p> <p>4) Take off the hooks of front panel from top side of the back body.</p>  <p>5) Slightly open the lower part of the front panel then pull the upper part of the front panel toward you to remove it as shown on figure</p>  <p style="text-align: center;">Front panel</p> 	

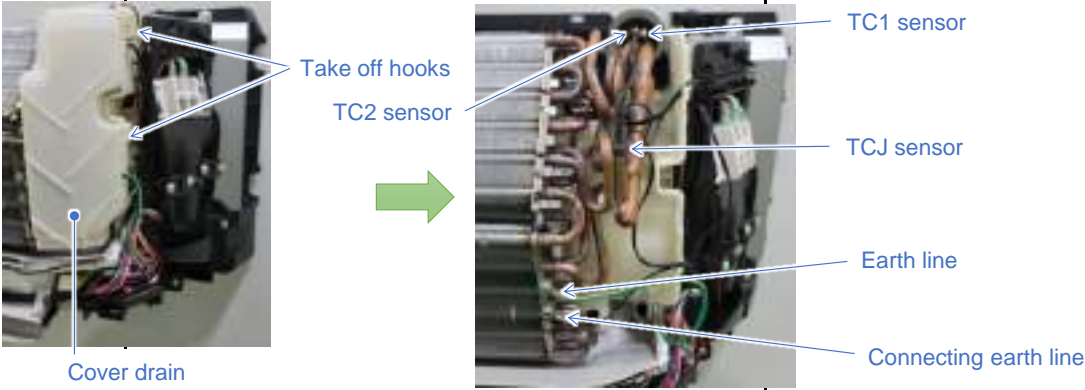
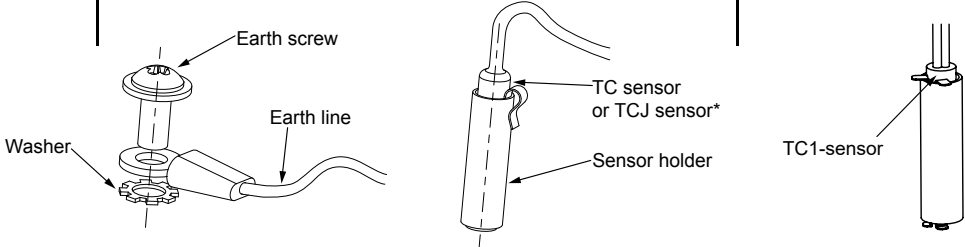



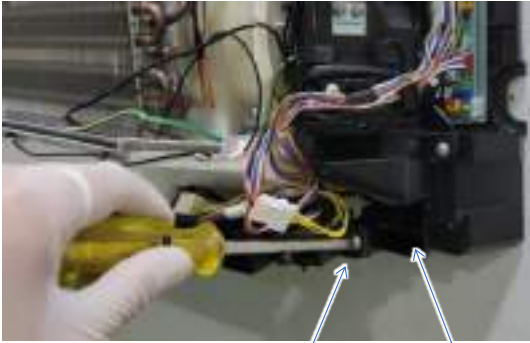
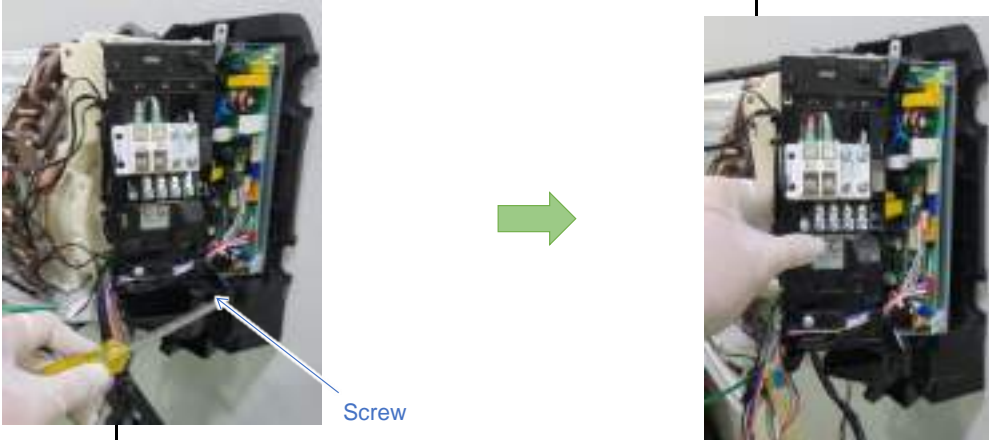

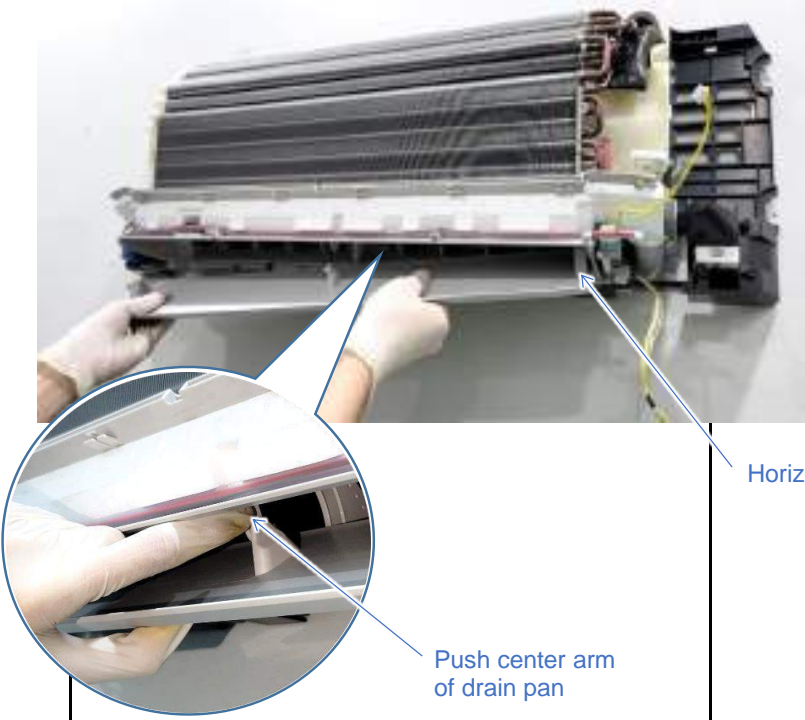
No.	Part name	Procedures	Remarks
④	Electrical part	<p>1) Follow the procedure item ③.</p>  <p>TC1 sensor TC2 sensor TA sensor TCJ sensor Earth line Power supply LED connector Unit LED display</p> <p>2) Remove screw holding the electrical part cover. 3) Remove screw High voltage partition.</p>  <p>Screw Electric part cover Pull out</p>  <p>High voltage partition Screw</p> <p>4) Disconnect the connectors for the fan motor and vertical louver motor from P.C. board assembly. 5) Remove TA sensor from the cover drain.</p>  <p>Fan motor Vertical louver & Horizontal louver</p>  <p>TA sensor Cover drain</p>	

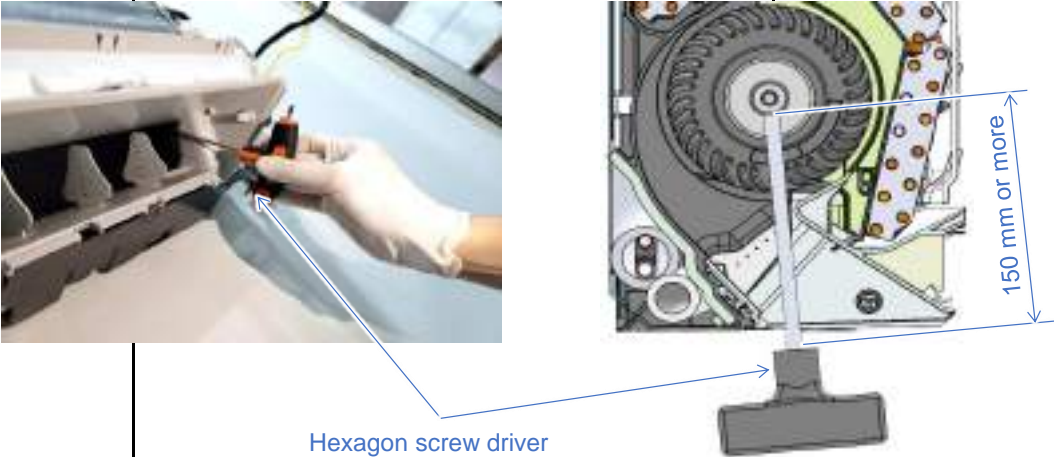
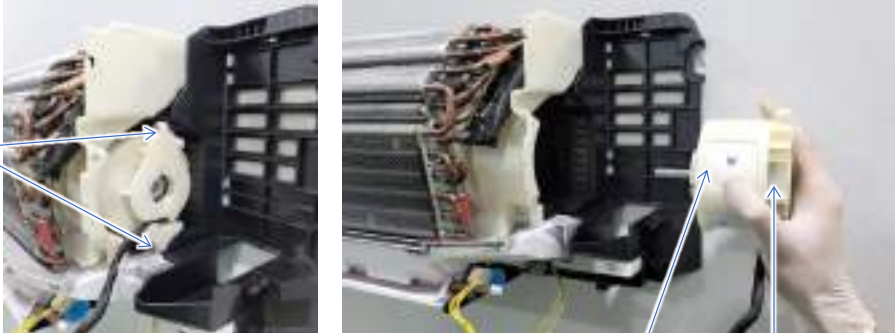
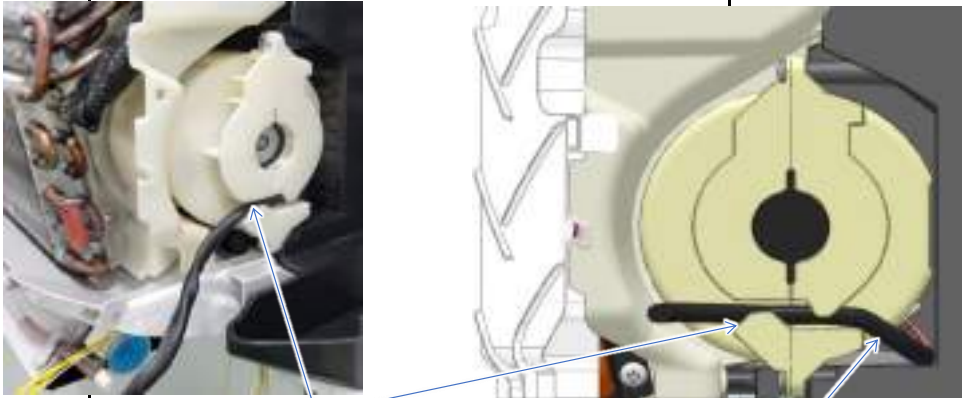
No.	Part name	Procedures	Remarks
④	Electrical part	<p>6) Remove the cover drain from main unit.</p>  <p>7) Remove the earth screw, earth line and connecting ground line from the evaporator.</p> <p>8) Pull out TC1, TC2 and TCJ sensor from sensor holder of the evaporator.</p>  <p>9) Disconnect the connector of Ionizer, Horizontal louver motor</p> 	

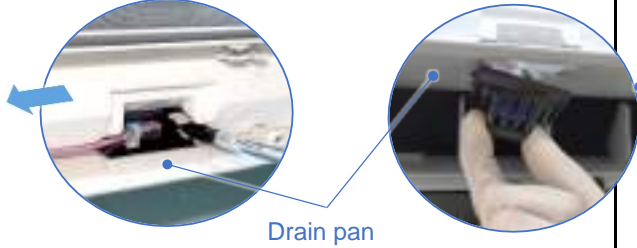
No.	Part name	Procedures	Remarks
④	Electrical part	<p>10) Remove the fixing screw that secures unit LED display then pull out from main body.</p>  <p>Unit LED display Screw</p> <p>11) Remove the fixing screw that secures the electrical box then pull out from main body.</p>  <p>Screw</p>	

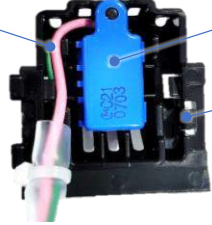
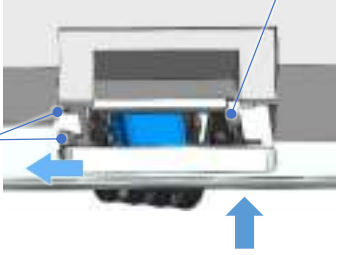

No.	Part name	Procedures	Remarks
5	Horizontal louver	<p>1) Remove center shaft of the horizontal louver from the drain pan then remove side shaft.</p>  <p>Horizontal louver</p> <p>Push center arm of drain pan</p>	

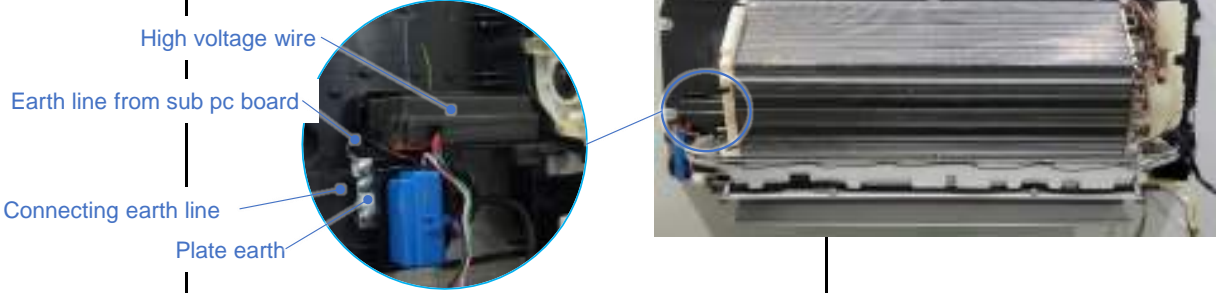
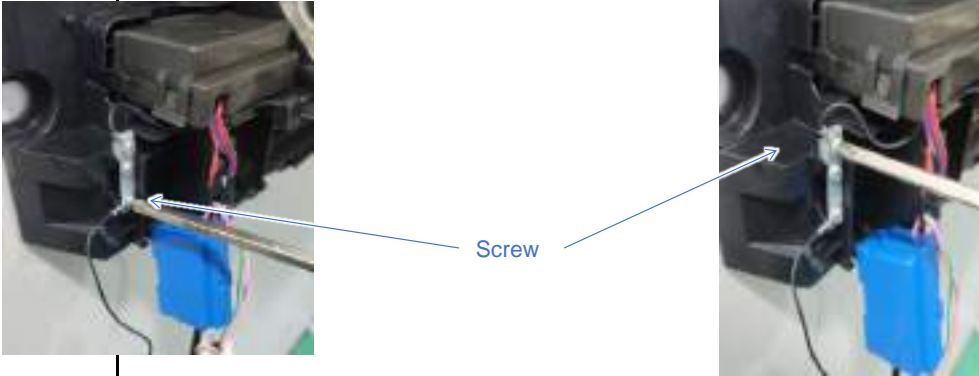
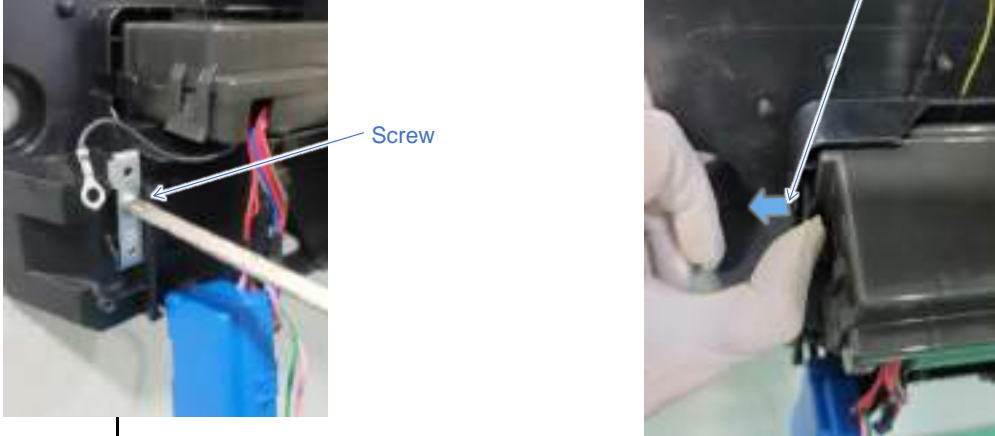

No.	Part name	Procedures	Remarks
⑥	Fan motor	<p>1) Follow the procedure item ③, ④ and ⑤</p> <p>2) Loosen the set screw of the cross flow fan.</p>  <p>Hexagon screw driver</p> <p>3) Remove 2 fixing screws of the motor band.</p> <p>4) Pull motor band and fan motor outward.</p>  <p>Screws</p> <p>Fan motor</p> <p>Motor band</p> <p><To re-installation></p> <ul style="list-style-type: none"> - Check the type name of fan motor. - Keep connector position and arrange fan motor wires follow figure.  <p>Fan motor wire</p> <p>Fan motor connector</p>	

No.	Part name	Procedures	Remarks
7	Plasma ion assembly	<p>1) Follow the procedure item ③ 2) Disconnect the plasma ion connector.</p>  <p>3) Remove cover ion by push hooking claw to left side direction and then pulling out of the drain pan.</p>  <p>4) Pulling out the high voltage unit from back body.</p>  <p><To re-installation> - Arrange high voltage wire follow the figure.</p>  <p>- Insert 2 ribs into the drain pan. - Press hooking claw to the drain pan.</p> 	  

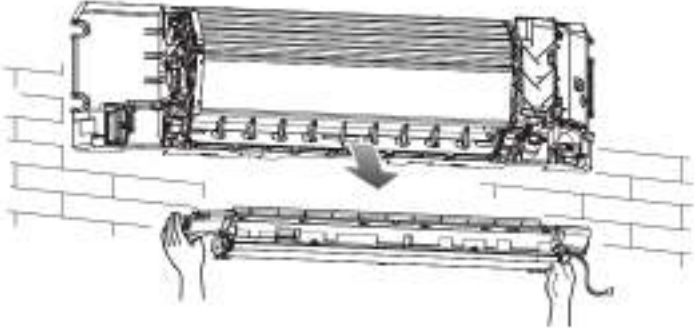
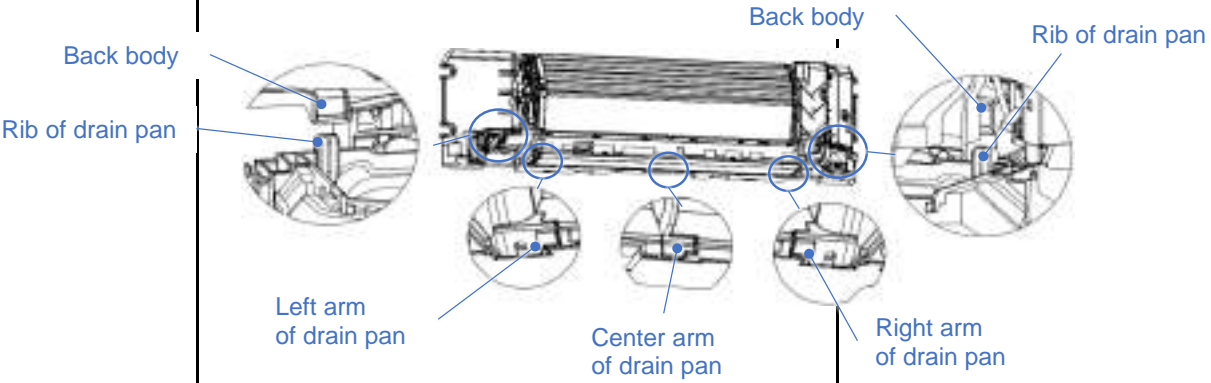
No.	Part name	Procedures	Remarks
8	Cover sub pc board assembly	<p>1) Follow the procedure item ③</p>  <p>2) Remove fixing screw from connecting earth line and earth line from sub P.C. board</p>  <p>3) Remove fixing screw for take off plate earth. 4) Press hooking claw to left side for take off cover sub P.C.board.</p> 	

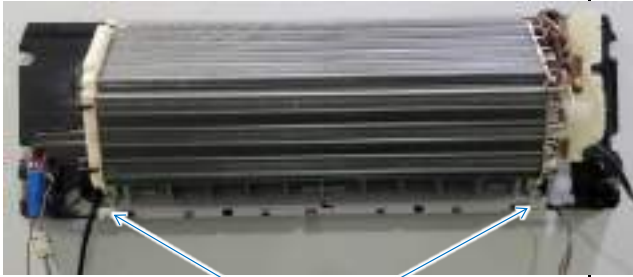

No.	Part name	Procedures	Remarks
9	Drain pan assembly	<p>1) Follow the procedure item ③</p> <p>2) Remove fixing screw of the unit display and remove unit display.</p>  <p>3) Disconnect the cord motor of Louver-HR (5P)</p> <p>4) Disconnect the plasma ion connector.</p> <p>5) Remove cover ion by push hooking claw to left side direction and then pulling out of the drain pan.</p>  <p>6) Remove fixing screw of drain pan 2 positions follow the figure.</p> 	     

No.	Part name	Procedures	Remarks
⑨	Drain pan assembly	<p>7) Remove drain pan can be selected remove drain hose or not remove drain hose following:</p> <p>- Not remove drain hose; Pulling out the drain pan from back body, then holding the drain pan with main unit.</p>  <p style="text-align: center;">Drain pan</p> <p>- Remove drain hose; Drain hose can be removed follow the procedure item⑨. After that remove the drain pan from main unit.</p>  <p><To re-installation></p> <ul style="list-style-type: none"> - Press the drain pan into the back body. - Please make sure ribs of drain pan in left and right side must be install to lock position. - Press the right, left and center arms of drain pan to back body. 	

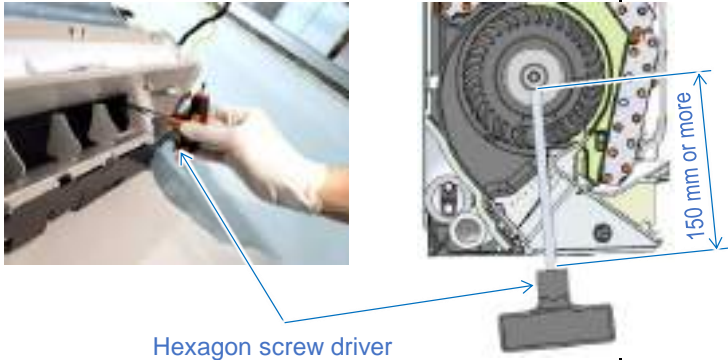
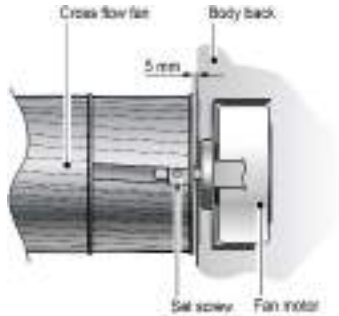
No.	Part name	Procedures	Remarks
⑪	Vertical louver assembly	<p>1) Remove drain pan follow the procedure item ③ and ⑧.</p>  <p style="text-align: center;">Screws</p> <p>2) Remove 2 fixing screws from the base vertical louver, then remove the vertical louver assembly from the main body.</p>  <p style="text-align: center;">Vertical louver assembly</p>	

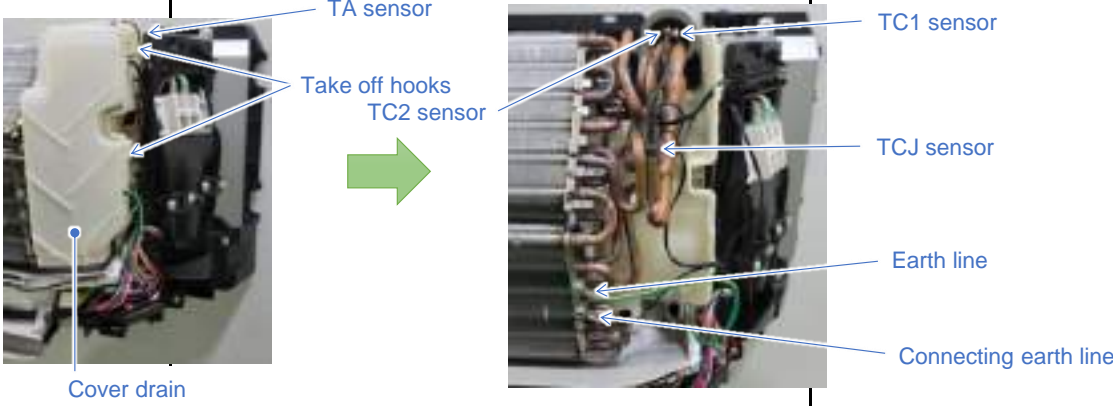
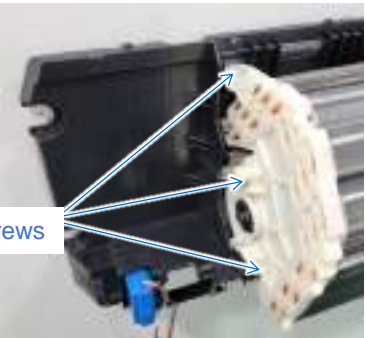
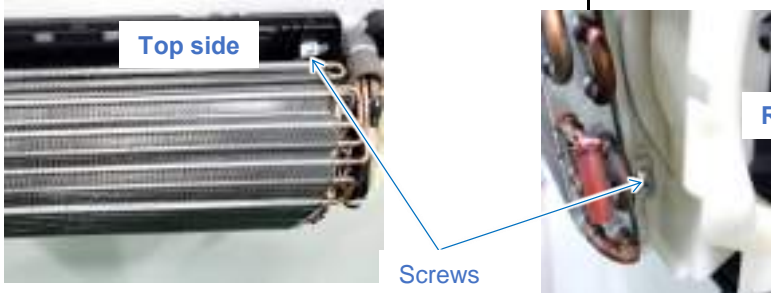
No.	Part name	Procedures	Remarks
12	Cross flow fan	<p>1) Follow the procedure item (8) and (10). 2) Loosen the set screw of the cross flow fan.</p>  <p>Hexagon screw driver</p> <p>3) Remove 2 fixing screws from the bearing base and 3 fixing screws of evaporator, then remove it from the main unit.</p>   <p>4) Lift up the heat exchanger follow the figure. Pull out the left hand side until the cross flow fan released from the shaft of the fan motor and then pull out the lower side of heat exchanger follow the figure.</p>  <p><To re-installation> 1) To incorporate the fan motor and the motor into the position in the following figure.</p>  <p>- Install the cross flow fan so that the right end if the 1st joint from the right of the cross flow fan is keep 5mm from closed wall of the main unit.</p>	

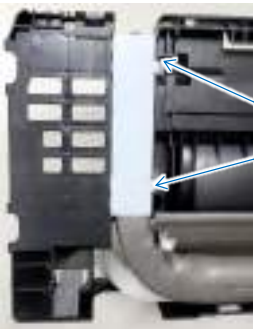
No.	Part name	Procedures	Remarks
⑬	Heat exchanger (Evaporator)	<p>1) Follow the procedure item ③ .</p> <p>2) Remove TA sensor, cover drain, TC1,TC2,TCJ sensor and earth line/connecting earth line from the heat exchanger.</p>  <p>3) Remove 3 fixing screws at the left side of the heat exchanger.</p>  <p>4) Remove 2 fixing screws at the upper and the bottom right side of the heat exchanger.</p> 	

No.	Part name	Procedures	Remarks
⑬	Heat exchanger (Evaporator)	<p>5) Remove the pipe holder from the rear side of the main unit.</p>  <p>6) Pull out the heat exchanger to upper side</p>  <p><To re-installation></p> <ul style="list-style-type: none"> - Keep the back body horizontally and put the heat exchanger to the back body - Make sure the heat exchanger can be assembled with the back body and secure it tightly with screws. 	

Microcomputer

No.	Part name	Procedure	Remarks
①	Common procedure	1) Turn the power supply off to stop the operation of air-conditioner. 2) Remove the front panel. • Remove the 2 fixing screws. 3) Remove the electrical part base.	Replace terminal block, microcomputer ass'y and the P.C. board ass'y.

12. Replacement of P.C. Board for Indoor Unit Servicing

<Models>

MMK-UP****DHPL Series

<Note : when replacing the P.C. board for indoor unit servicing>

The nonvolatile memory (hereafter called EEPROM, IC503) on the indoor unit P.C. board before replacement includes the model specific type information and capacity codes as the factory-set value and the important setting data which have been automatically or manually set when the indoor unit is installed, such as system/indoor/group addresses, high ceiling select setting, etc. When replacing the P.C. board for indoor unit servicing, follow the procedures below. After replacement completes, confirm whether the settings are correct by checking the indoor unit No., Group header unit/follower unit settings and perform the cooling cycle confirmation through the trial operation.

<Replacement procedures>

■ Case 1

Before replacement, the indoor unit can be turned on and the setting data can be read out by wired remote control operation.

EEPROM data read out [1] (Refer to page 1)



Replacement of P.C. board for Indoor unit servicing and power on [2] (Refer to page 2.)



Writing the read out EEPROM data [3] (Refer to page 2.)



Power reset(for all indoor units connected to the remote control when the group operation control is performed.)

■ Case 2

The EEPROM before replacement is defective and the setting data cannot be read out.



Writing the setting data to EEPROM, such as high ceiling installation setting and optional connection setting, etc., based on the customer information. [3] (Refer to page 2.)



Power reset (for all indoor units connected to the remote control when the group operation control is performed.)

[1] Setting data read out from EEPROM



The setting data modified on the site, other than factory-set value, stored in the EEPROM shall be read out.

Step 1 Press ,  and  button on the remote control simultaneously for more than 4 seconds.



When the group operation control is performed, the unit No. displayed for the first time is the header unit No.

At this time, the CODE No.(DN)shows . Also, the fan of the indoor unit selected starts its operation and the swing operation also starts if it has the louvers.



Step 2 Every time when the  button is pressed, the indoor unit No. under the group control is displayed in order. Specify the indoor unit No. to be replaced.

1. Change the CODE No.(DN) to  by pressing  /  buttons for the temperature setting.
(this is the setting for the filter sign lighting time.)

At this time, be sure to write down the setting data displayed.

2. Change the CODE No.(DN) by pressing  /  buttons for the temperature setting.
Similarly, be sure to write down the setting data displayed.

3. Repeat the step 2-2 to set the other settings in the same way and write down the setting data as shown in the table 1(example)on page 4.

* The CODE No.(DN)are ranged from  to . The CODE No.(DN) may skip.

Step 3 After writing down all setting data, press  button to return to the normal stop status.
(It takes approx. 1 min until the remote control operation is available again.)

CODE No.required at least

DN	Contents
10	Type
11	Indoor unit capacity
12	System address
13	Indoor unit address
14	Group address
FC	Communication protocol
1FC	Indoor Unit terminating resistance

1. The CODE No. for the Indoor unit type and Indoor unit capacity are required to set the rotation number setting of the fan.
2. If the system/indoor/group addresses are different from those before replacement, the auto-address setting mode starts and the manual resetting may be required again.
(when the multiple units group operation including twin system.)

[2] P.C. Board for indoor unit servicing replacement procedures

Step 1 Replace the P.C. board to the P.C. board for indoor unit servicing.

At this time, perform the same setting of the jumper wire(J01, J08, J09)setting(cut),switch SW501, (short-circuit) connector CN34 as the setting of the P.C. board before replacement.

If the plug for short-circuit is attached on the P.C. board before replacement, attach it on the P.C. board replaced.

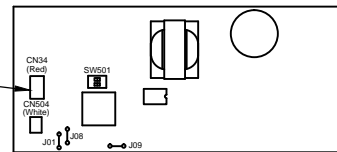

Step 2 It is necessary to set Indoor unit to be exchanged : Remote controller = 1:1

Based upon the system configuration, turn on power of the indoor unit with one of the following items.

1) Single (Individual) operation

Turn on power of the indoor units and proceed to [3].

2) Group operation

A) In case that power of the exchanged indoor unit only can be turned on

Turn on power of the exchanged indoor unit only and proceed to [3].

B) In case that power of the indoor units cannot be turned on individually (Case 1)

a) Remove temporarily the group wire connected to the terminal blocks A and B of the exchanged indoor unit.

b) After connecting the remote controller wire only to the removed terminal block, turn on power of the indoor units and proceed to [3].

When the above methods cannot be used, follow to the two cases below.

C) In case that power of the indoor units cannot be turned in individually (Case 2)

a) Remove all CN41 connectors of the indoor units in the same group except those of the exchanged indoor unit.

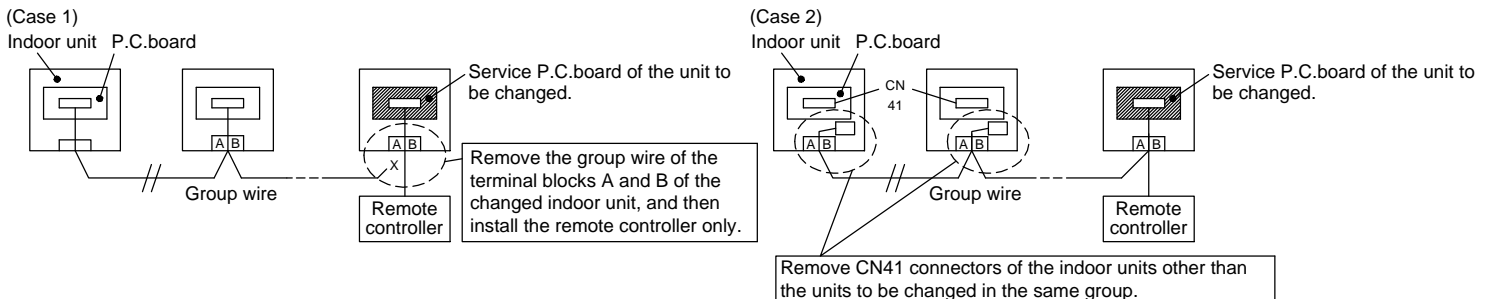

b) Turn on power of the indoor units and proceed to [3].

After [3] operation has finished, be sure to return the temporarily removed group wire or CN41 connector to the original connection.



[3] Writing the setting data to EEPROM

The settings stored in the EEPROM of the P.C. board for indoor unit servicing are the factory-set values.



Step 1 Press ,  and  buttons on the remote control simultaneously for more than 4 seconds.

* In the group control operation, the unit No. displayed for the first time is the header unit No.

At this time, the CODE No. (DN) shows . Also, the fan of the indoor unit selected starts its operation and the swing operation starts if it has the louvers.









(The unit No. **ALL** is displayed if the auto-address setting mode is interrupted in [2] step 2 a) 2. on previous page.)

Step 2 Every time when the  button is pressed, the indoor unit Nos. in the group control operation are displayed in order.
 (The settings stored in the EEPROM of the P.C. board for indoor unit servicing are the factory-set values.)
 Specify the indoor unit No. with its P.C. board replaced to the P.C. board for indoor unit servicing.
 (You cannot perform this operation if **ALL** is displayed.)

Step 3 Select the CODE No. (DN) can be selected by pressing the  /  button for the temperature setting.

- Set the indoor unit type and capacity.

The factory-set values shall be written to the EEPROM by changing the type and capacity.



1. Set the CODE No. (DN) to **10** . (without change)
2. Select the type by pressing  /  buttons for the timer setting.
 (For example, High wall is set to "0008".
 Refer to table 2 on page 4.)
3. Press  button. (The operation completes if the setting data is displayed.)
4. Change the CODE No. (DN) to **11** by pressing  /  buttons for the temperature setting.
5. Select the capacity by pressing  /  buttons for the timer setting.
 (For example, 018 Type is set to "0009". Refer to table 2 on page 4.)
6. Press  button. (The setting completes if the setting data are displayed.)
7. Press the  button to return to the normal stop status.

(It takes approx. 1 min until the remote control operation is available again.)

Write the on-site setting data to the EEPROM, such as address setting, etc. Perform the steps 1 and 2 above again.

Change the CODE No. (DN) to **01** by pressing  /  buttons for the temperature setting. (this is the setting for the filter sign lighting time.)

Check the setting data displayed at this time with the setting data put down in [1] (on page 1).

1. If the setting data is different, modify the setting data by pressing  /  buttons for the timer setting to the data put down in [1].

The operation completes if the setting data is displayed.

2. If the data is the same, proceed to next step.



Change the CODE No. (DN) by pressing  /  buttons for the temperature setting.

As described above, check the setting data and modify to the data put down in [1].

Repeat the steps 6 and 7.

After the setting completes, press  button to return to the normal stop status.

(It takes approx. 1 min until the remote control operation is available again.)

* The CODE No. (DN) are ranged from **01** to **41b** .The CODE No. (DN) is not limited to be serial No. Even after modifying the data wrongly and pressing  button, it is possible to return to the data before modification by pressing  button if the CODE No. (DN) is not changed.

<Fig. 1 RBC-AMTU31E>

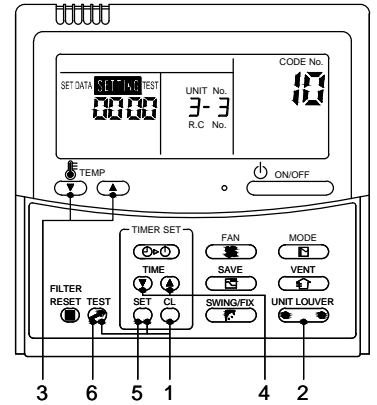

<Fig.2 EEPROM layout diagram>

The EEPROM (IC503) is attached to the IC socket. When detaching the EEPROM, use a tweezers, etc. Be sure to attach the EEPROM by fitting its direction as shown in the figure.

* Do not bend the IC lead when replacing.

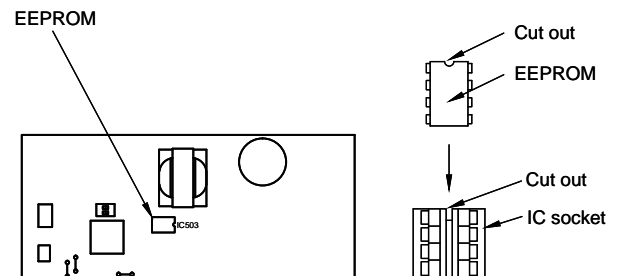

<Fig.2>

Table 1. Setting data(CODE No. table(example))

DN	Item	Setting data	Factory-set value
01	Filter display delay timer		0002 : 2500H
02	Dirty state of filter		0000 : Standard
03	Central control address		00Un/0099 : Unfixed
04	Specific indoor unit priority		0000 : No priority
06	Heating suction temperature shift		0002 : +2°C
0D	Automatic mode		0001 : No automatic
0F	Cooling only		0000 : Heat pump
10	Type		Depending on model type
11	Indoor unit capacity		According to capacity type
12	Line address		00Un/0099 : Unfixed
13	Indoor unit address		00Un/0099 : Unfixed
14	Group address		00Un/0099 : Unfixed
19	Flap type (Wind direction adjustment)		Depending on Type
1E	Temperature range of cooling/heating automatic SW control point		0003 : 3 deg (Ts±1.5)
28	Automatic restart of power failure		0000 : None
2A	Selection of option / Trouble input (TCB-PCUC2E: CN3)		0002 : None
2B	Thermo output SW		0000 : Thermo ON
2E	HA terminal (CN61) select		0000 : Usual (HA terminal)
31	Ventilating fan control		0000 : Unavailable
32	Sensor SW		0000 : Body sensor
33	Temperature unit select		0000 : Centigrade (°C)
5D	External static pressure		0000 : Default setting
60	Timer setting (wired remote controller)		0000 : Available
7A	Change unit 0.5°C or 1.0°C on remote		0000 : 0.5°C
D0	Remote controller operation save function		0001 : Enable
E0	Region	0004 : Global model	0000 : Japan model
F6	Presence of Application control kit (TCB-PCUC2E)		0000 : None
FC	Communication protocol		0000 : TCC-LINK
FE	FS unit adress		00Un/0099 : Unfixed
1Fb	Remote controller operation		0000 : Operation possible
1FC	Indoor Unit terminating resistance		0000 : OFF

Table 2. Type : CODE No.10

Setting data	Type	Type name abb.
0001 *1	4-way Air Discharge Cassette Type	MMU-UP****HP Series
0008	High wall Type	MMK-UP****DHPL Series

*1 EEPROM initial value on the P.C. board for indoor unit servicing.

*2  **CAUTION**

< Model name MMK-UP****DHPL Series >
For the above model. Set the CODE no. to "E0" the setting data "0000" (initial) to "0004"

Table 3. Indoor unit capacity : CODE No.11

Setup data	Model
0000 *1	Invalid
0041	005 type
0001	007 type
0003	009 type
0005	012 type
0007	015 type
0009	018 type

13. EXPLODED VIEWS AND PARTS LIST

Indoor Unit

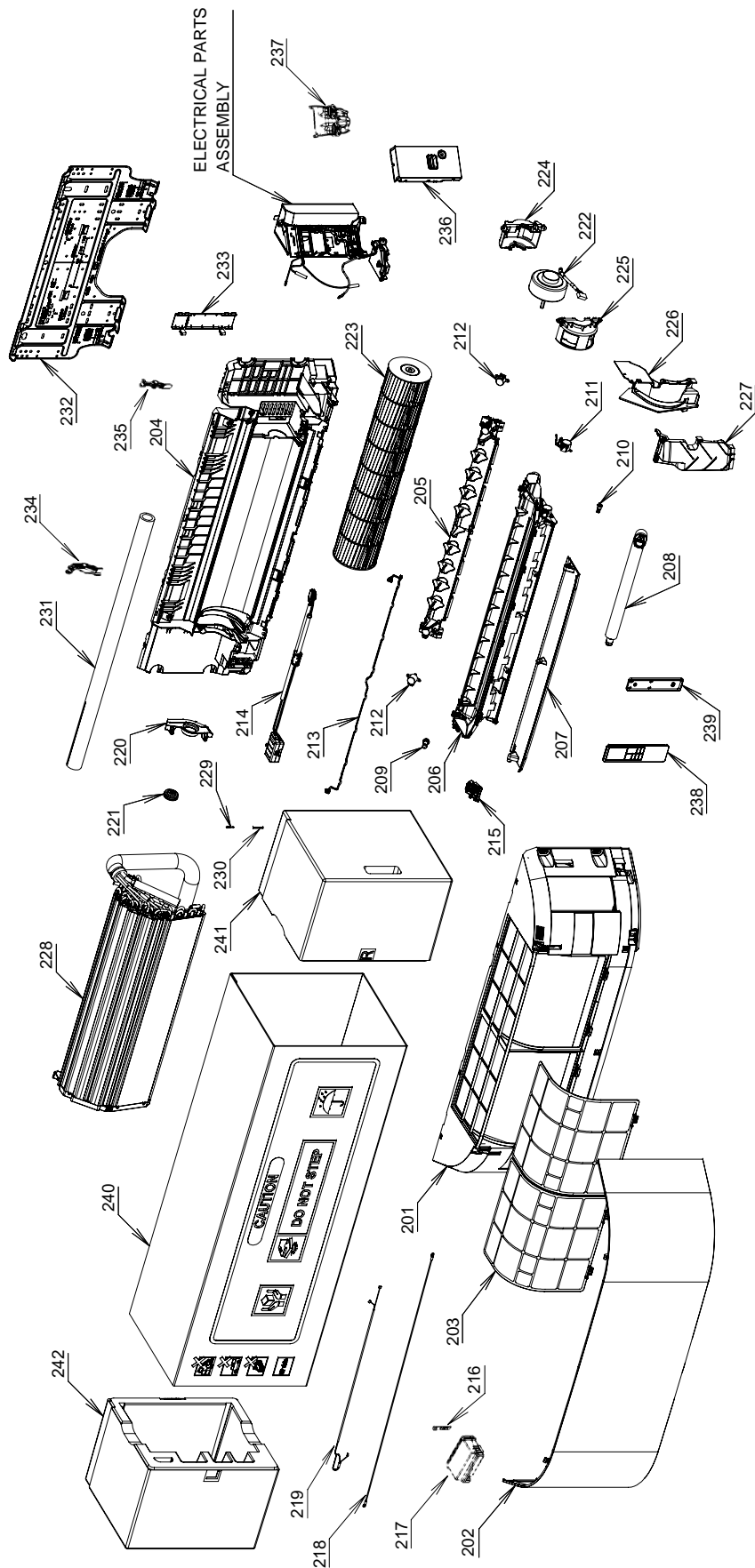

Location No.	Part No.	Description	Model name MMK-UP****DHPL-E(TR)					
			0051	0071	0091	0121	0151	0181
201	43T00935	FRONT PANEL ASSY	1	1	1	1	-	-
201	43T00936	FRONT PANEL ASSY	-	-	-	-	1	1
202	43T09592	GRILLE OF AIR INLET ASSY	1	1	1	1	1	1
203	43T80363	AIR FILTER	2	2	2	2	2	2
204	43T03427	BODY BACK ASSY	1	1	1	1	1	1
205	43T22401	VERTICAL LOUVER ASSY	1	1	1	1	1	1
206	43T72407	DRAIN PAN ASSY	1	1	1	1	1	1
207	43T22402	HORIZONTAL LOUVER ASSY	1	1	1	1	1	1
208	43T70321	DRAIN HOSE	1	1	1	1	1	1
209	43T79322	DRAIN CAP	1	1	1	1	1	1
210	43125202	COVER-AXIS	1	1	1	1	1	1
211	43T21478	MOTOR; STEPPING	1	1	1	1	1	1
212	43T21434	STEPPING-MOTOR	2	2	2	2	2	2
213	43T60622	LEAD MOTOR	1	1	1	1	1	1
214	43T80371	HIGH VOLTAGE UNIT ASSY	1	1	1	1	1	1
215	43T80354	IONIZER UNIT COVER	1	1	1	1	1	1
216	43T07345	PLATE EARTH	1	1	1	1	1	1
217	43T08439	COVER SUB PC BOARD	1	1	1	1	1	1
218	43T60623	CONNECTING GROUND ASSY	1	1	1	1	1	1
219	43T60624	CONNECTING UART&LED ASSY	1	1	1	1	1	1
220	43T22403	BASE BEARING ASSY	1	1	1	1	1	1
221	43T22312	BEARING ASSY, MOLD	1	1	1	1	1	1
222	43T21515	MOTOR-FAN	1	1	1	1	1	1
223	43T20361	CROSS FLOW FAN ASSY	1	1	1	1	1	1
224	43T39423	MOTOR BAND BACK	1	1	1	1	1	1
225	43T39424	MOTOR BAND FRONT	1	1	1	1	1	1
226	43T39456	MOTOR COVER ASSY	1	1	1	1	1	1
227	43T79326	DRAIN COVER	1	1	1	1	1	1
228	43T44831	REFRIGERANT CYCLE ASSY	1	1	1	1	-	-
228	43T44832	REFRIGERANT CYCLE ASSY	-	-	-	-	1	1
229	43T19333	HOLDER, SENSOR	2	2	2	2	2	2
230	43T19321	FIX-P-SENSOR	1	1	1	1	1	1
231	43T11321	PIPE-SHIELD	1	1	1	1	1	1
232	43T82346	INSTALLATION PLATE ASSY	1	1	1	1	1	1
233	43T49388	PIPE HOLDER	1	1	1	1	1	1
234	43T79328	DRAIN COVER LEFT	1	1	1	1	1	1
235	43T79329	DRAIN COVER RIGHT	1	1	1	1	1	1
236	43T62411	TERMINAL COVER ASSY	1	1	1	1	1	1
237	43T62412	BASE CLAMP ASSY	1	1	1	1	1	1
238	43T66448	WIRELESS REMOCO(WH-UB01UE)	1	1	1	1	1	1
239	43T66423	HOLDER, REMOTE CONTROL	1	1	1	1	1	1
240	43T91410	PACKING SLEEVE	1	1	1	1	1	1
241	43T91411	PACKING CUSHION RIGHT	1	1	1	1	1	1
242	43T91412	PACKING CUSHION LEFT	1	1	1	1	1	1

Indoor Unit (Part-E)

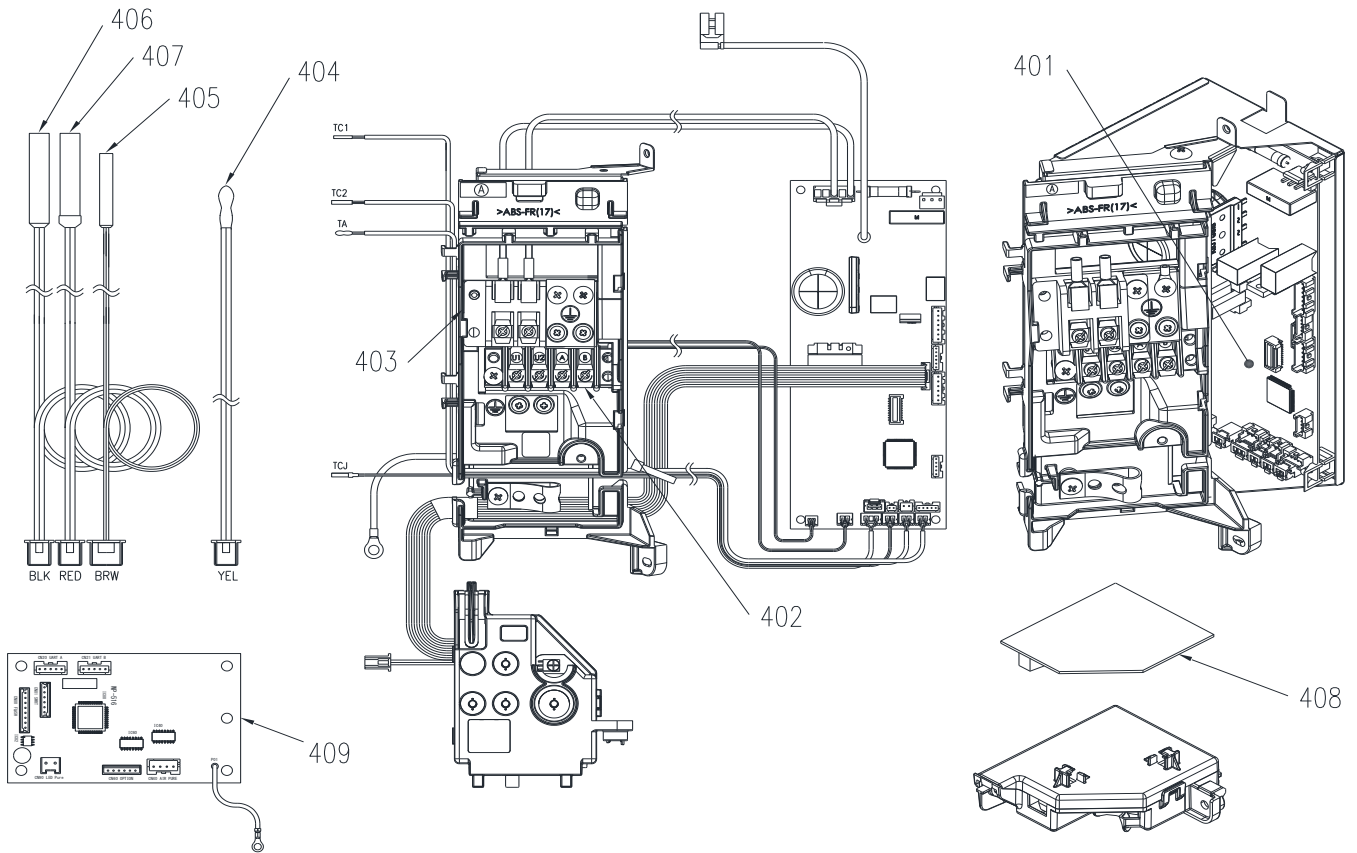

Location No.	Part No.	Description	Model name MMK-UP****DHPL-E(TR)					
			0051	0071	0091	0121	0151	0181
401	43TN9936	PC BOARD ASSY(MCC-1643)	1	1	1	1	1	1
402	43T60448	TERMINAL	1	1	1	1	1	1
403	43T60078	TERMINAL BLOCK	1	1	1	1	1	1
404	43T50413	TA-SENSOR	1	1	1	1	1	1
405	43T50410	TC-SENSOR	1	1	1	1	1	1
406	43T50393	TEMPERATURE SENSOR	1	1	1	1	1	1
407	43T50400	TEMPERATURE SENSOR	1	1	1	1	1	1
408	43TN9938	DISPLAY PC BOARD ASSY (WP-513)	1	1	1	1	1	1
409	43TN9937	PC BOARD ASSY(WP-516)	1	1	1	1	1	1

Toshiba Carrier (Thailand) Co., Ltd.

**144/9 MOO 5, BANGKADI INDUSTRIAL PARK, TIVANON ROAD, TAMBOL BANGKADI,
AMPHUR MUANG, PATHUMTHANI 12000, THAILAND.**