

TOSHIBA INSTALLATION MANUAL

To Qualified Installer in Installation Work and Service











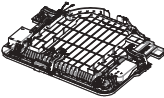





Air purifier kit
(For 4-Way cassette type)

Model: TCB-EAPC1UHP-E

- Thank you for purchasing Air purifier kit for TOSHIBA air conditioners.
- Read this manual carefully for correct installation of the Air purifier kit before starting work.
- After the installation is completed, execute a test run to check for normal operation and explain how to use and maintain the Air purifier kit to the customer according to the Operation Manual. Ask the customer to keep this manual with the Operation Manual.

Observe the safety precautions described in the Operation Manual of the Air purifier kit, Installation Manual of the 4-way cassette type air conditioner (indoor unit), or the Installation Manual supplied with the ceiling panel.

COMPONENTS

Part Name	Q'ty	Part Name	Q'ty
Main frame 	1	Battery 	2
Dust collector 	1	Actuator 	1
Deodorize filter 	2	Flat head wood screw (Ø3.1x16L [mm]) 	2
Wireless receiver and Dust sensor 	1	Earth screw 	1
Remote controller 	1	Screw (Ø4x10L [mm]) 	7
Remote controller holder 	1	Screw (Ø3x8L [mm]) 	2
		Cord clamp (Ø5.9 mm) 	1
		Cord clamp (Ø4.4 mm) 	1
		Operation Manual 	1
		Installation Manual (This Manual) 	1
		CD-ROM 	1

INSTALLATION DIAGRAM OF AIR PURIFIER KIT

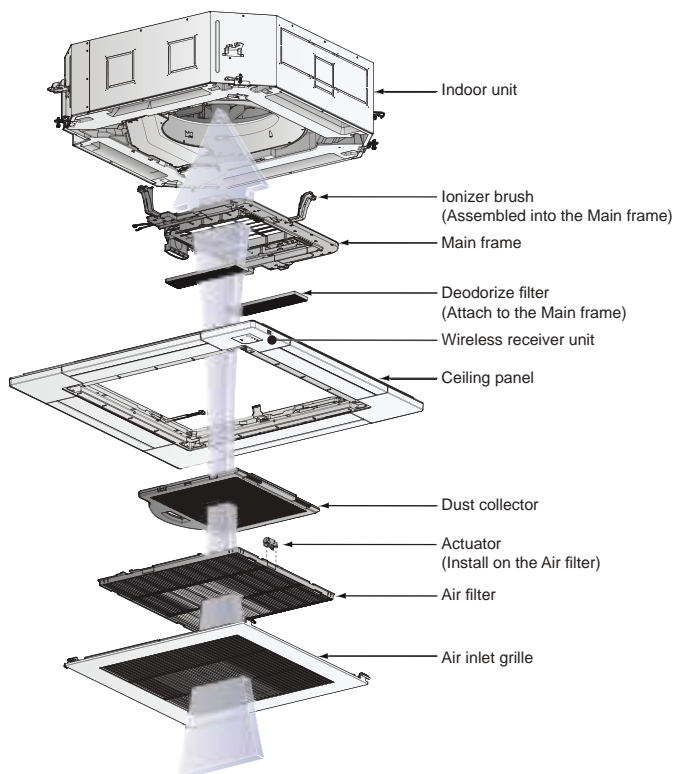

PREPARATION

Indoor unit preparation

To make screw holes of indoor unit are empty for the installation of the Air purifier kit.

So, some parts and current screws need to be disassembled.

CAUTION

- Be sure to stop operation of the air conditioner before work and then turn off switch of the breaker.
- Wear heavy work gloves during the installation work to avoid injury.

1. Remove the fan guard or cover sensor from indoor unit (depended on each model) follow position as below.
 - In case remove the fan guard

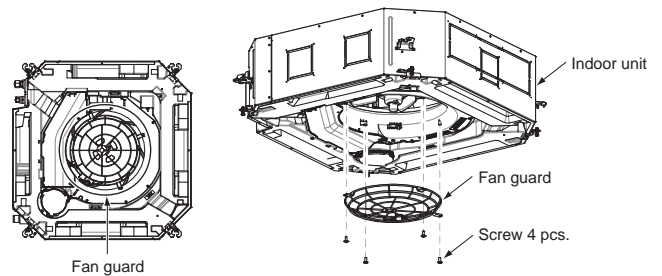

- In case remove the cover sensor

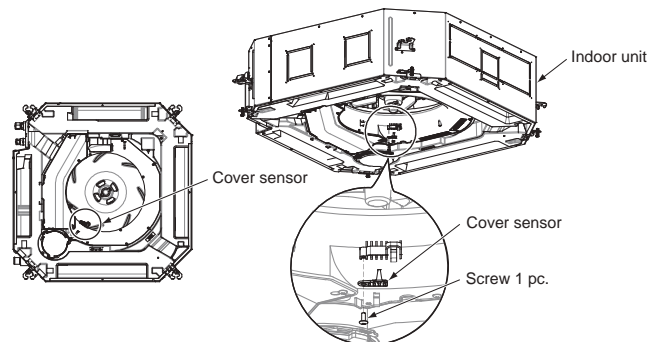

2. Remove screw that fixed the bell mouth with indoor unit 1 pc. as position below.

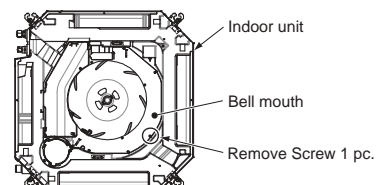

Note:

- After remove this screw, please keep it for fix the Air purifier kit with indoor unit for this position.

HOW TO INSTALL THE MAIN FRAME

1. Separate the Dust collector from the Main frame.

- Push hook of Main frame at handle position to unlock the Dust collector

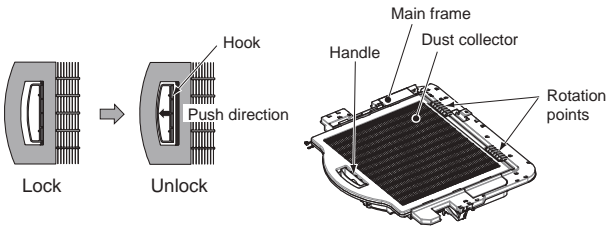

- Rotate the Dust collector then slide it out of the Main frame follow figure as below.

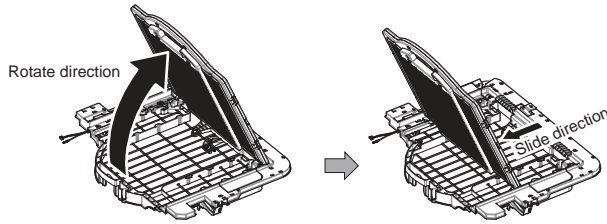

2. Rotate the lonizer arms (3 positions) to installation position until lock by hook of Main frame.

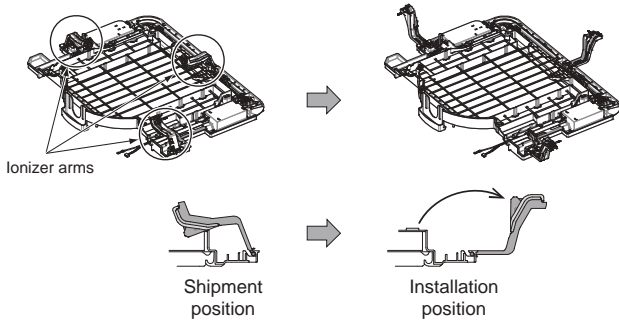

3. Attach the Main frame to the indoor unit follow position as figure below then fix by screw 6 pcs.

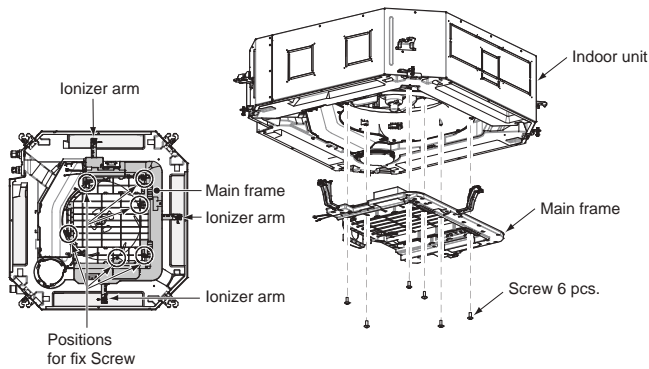

HOW TO INSTALL THE CEILING PANEL

You can refer the installation method from the Installation Manual of the ceiling panel.
The ceiling panel must be installed after the Main frame has been installed.

HOW TO INSTALL THE WIRELESS RECEIVER

- ※ Install the Wireless receiver in correct orientation, since the Wireless receiver can be installed at only one corner as shown in (Fig. 1).

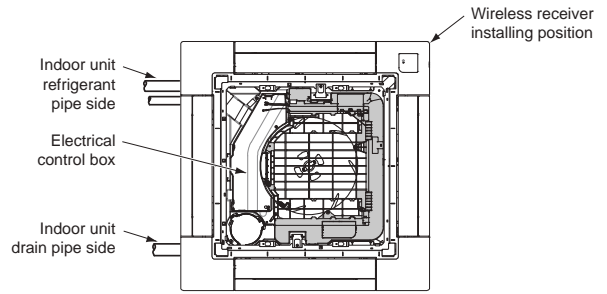

(Fig. 1)

1. Remove the air inlet grille.
2. Remove the adjust corner cap at the corner where the Wireless receiver is to be installed. (Fig. 2)

- Pull the adjust corner cap in the direction of (1) and slide it in the direction of (2) to remove it.
- Remove strap from the pin and detach the adjust corner cap from the ceiling panel.

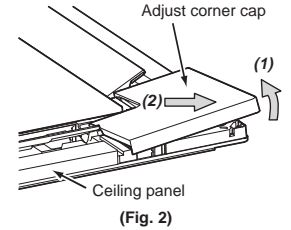

(Fig. 2)

3. The insulation pad is packed in the two rectangular holes for ceiling panel wires. Remove the insulation pad, and pass the wires from the Wireless receiver unit through the rectangular holes. (Fig. 3)
4. Make sure that the black sponge wrapped around the wiring is about 20 mm out of the rectangular hole on the indoor unit side, and fix it with the cord clamp by screw. (Fig. 3)

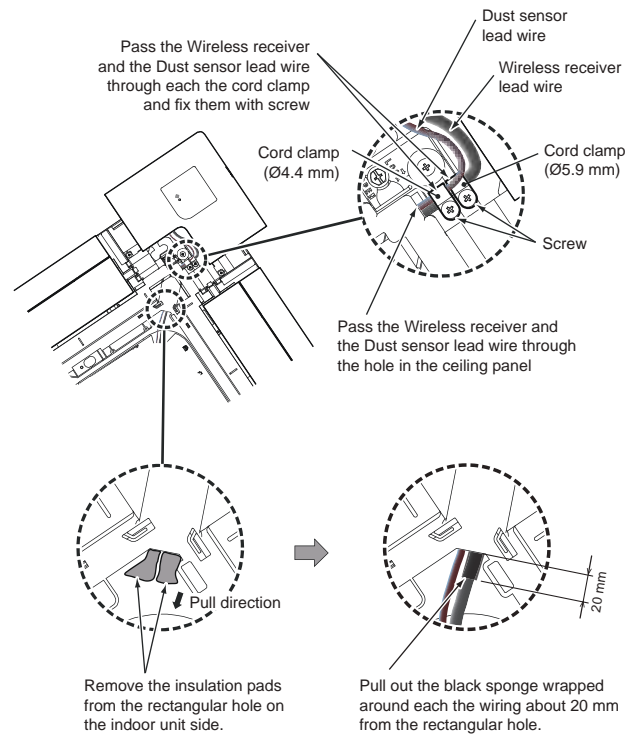

(Fig. 3)

CAUTION

- If the black sponge is not properly positioned, water leakage, dew condensation, and dew condensation on the wiring may occur, so be sure to do so.

- Attach the Wireless receiver unit to the panel. At this time, be careful not to pinch the wiring. (Fig. 4) If there is a part where the claws of the Wireless receiver part are not fitted, it may cause water leakage, so push claws A (2 places) and claws B (3 places) firmly and firmly to make sure that the Wireless receiver unit part does not float. please confirm.

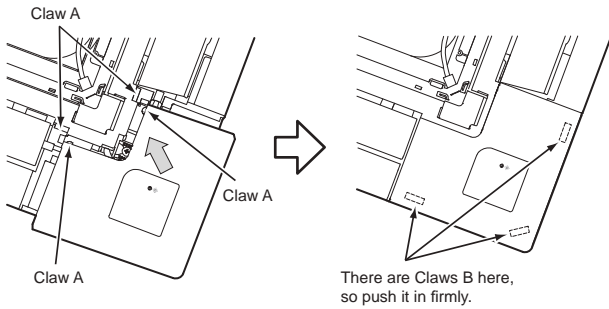

Insert the claw A (2 places) of the Wireless receiver unit into the square holes of the panel in the direction of the arrow.

Push in the claw B (3 places) on the back side of the Wireless receiver unit so that they fit.

(Fig. 4)

CAUTION

- Press the three claws B of the Wireless receiver firmly as far as they will go, and then check that the Wireless receiver is closely attached.
- Failure to do so may result in water leakage.

HOW TO WIRING THE WIRELESS RECEIVER AND AIR PURIFIER KIT

- Remove the mounting screw A on the electrical control box cover and loosen the screw B. Slide the cover inward to remove the hook (the electrical control box cover remains hooked on the hinge).
- Remove the mounting screw that fix the option PCB. cover then slide it inward to remove the hooks. After that rotate the option PCB. cover for open it.

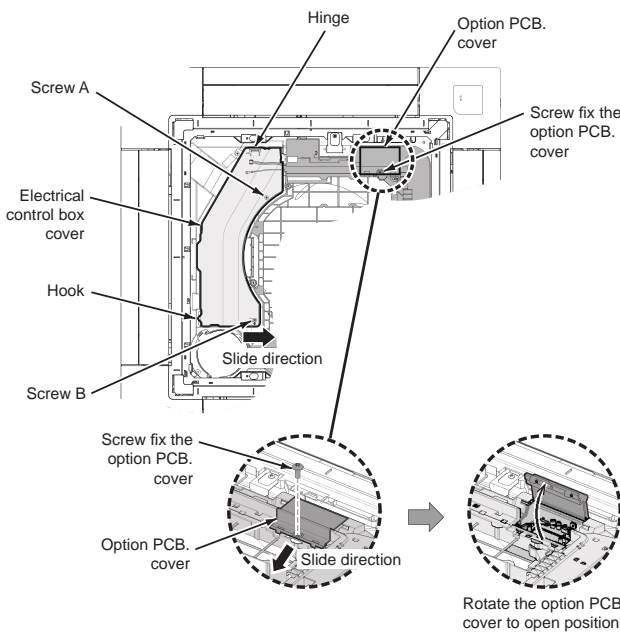

- Connect the connector (6 pin) of Dust sensor cable to (CN30) and connect the connector (4 pin) of Wireless receiver cable to (CN10) on the option P.C. board of the Air purifier kit.

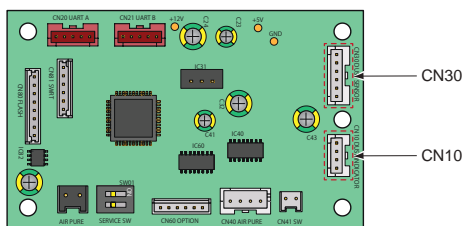

The option P.C. board of the Air purifier kit

- Pass the Wireless receiver lead wire from the ceiling panel through the claws of the Main frame then wiring it to the electrical control box of indoor unit (Fig. 5).

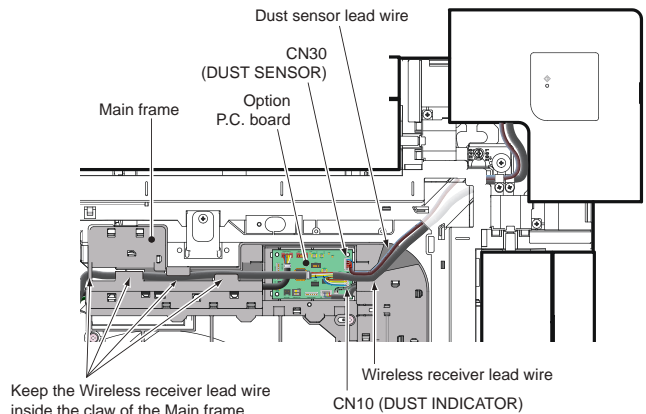

(Fig. 5)

- Connect the ground lead wire of the Air purifier to the electrical control box of indoor unit as the specified position by the earth screw which provided as accessory. (Fig. 6)

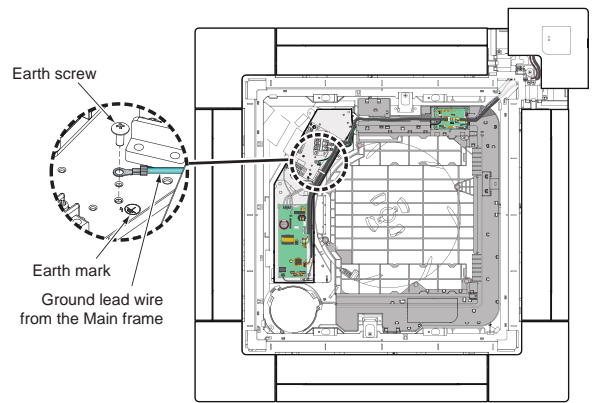

(Fig. 6)

- Connect the wiring from the Wireless receiver unit to (CN214) and connect wiring from the Main frame (UART wire) to (CN521) on the P.C. board of the indoor unit. (Fig. 7)
- Use the cord clamp inside the electrical parts box to process the excess wiring, and then attach the electrical control box cover and option P.C. board cover.

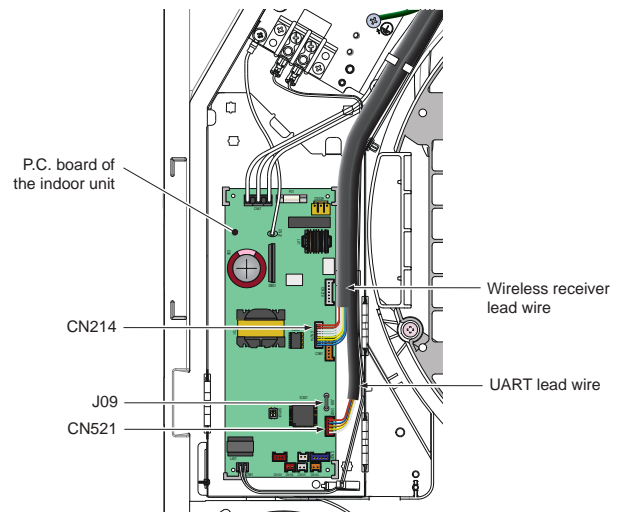

(Fig. 7)

NOTE

- If you do not connect the connector, the Air purifier kit will not operate, so be sure to connect it securely.
- Do not bundle these control signal wires with the power wire to avoid malfunction.

HOW TO INSTALL THE DEODORIZE FILTER

1. The Deodorize filters are included as an accessory, attach them into specified position of the Main frame when required.

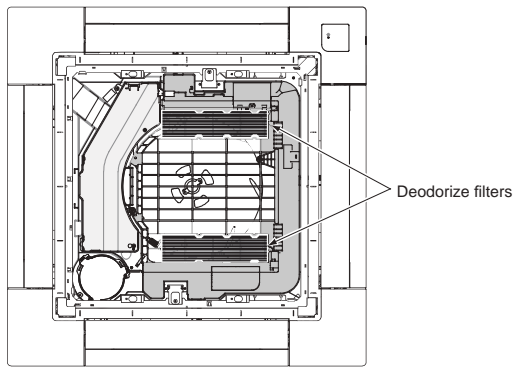

HOW TO INSTALL THE DUST COLLECTOR

1. Slide the Dust collector to hang on the Main frame then rotate it to fix with hook of the Main frame.

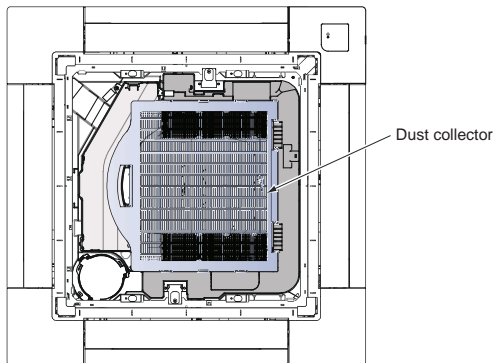
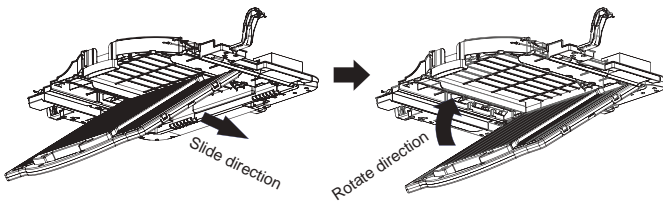

HOW TO INSTALL THE ACTUATOR

1. Attach the actuator to the frame of air filter as specified position then fix it by screw (M3x8L) 2 pcs.

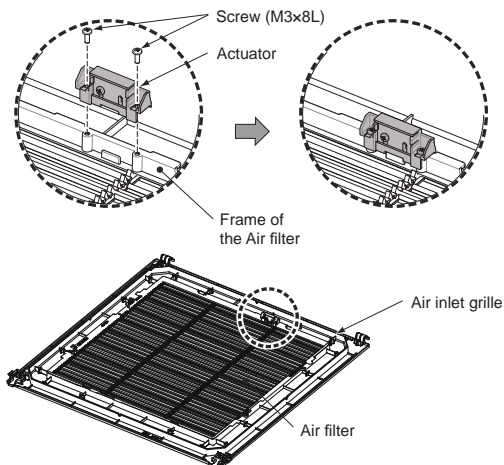

2. Attach the Air inlet grille to the Panel. At this time, be careful orientation of the actuator must be match with the sensor position on the Main frame.

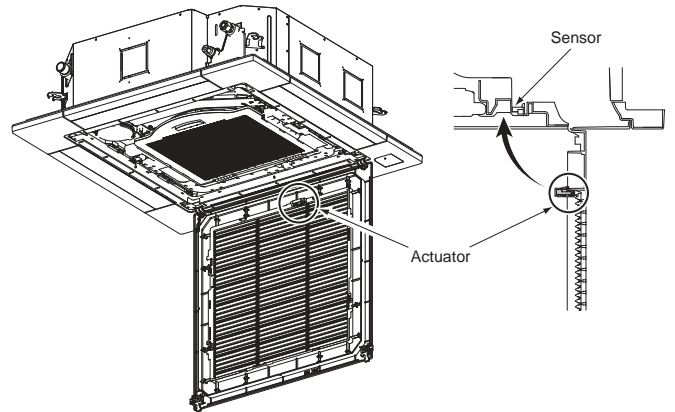
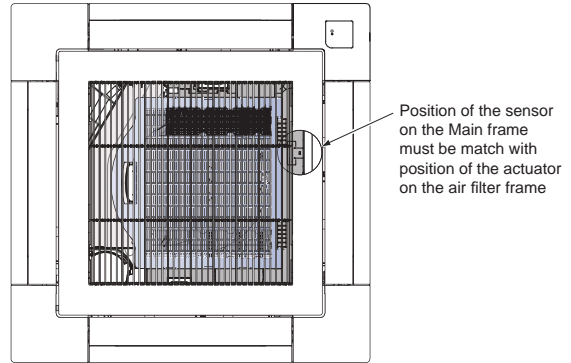

CAUTION

- If the actuator is not installed in the correct position the air purifier feature will not operate.

APPLICABLE CONTROLS SETUP (Setting at the site)

To activate the option P.C. board for the Air purifier kit, the settings in each case must be set as follows.

CAUTION

- Be sure to stop the air conditioner before making settings.

In Case 1: Jumper controller setting

There is a procedure to cut the jumper lead (J09) of the indoor unit P.C. board and set it when using the Wireless remote controller, but you must be careful because once it is set it cannot be undone. (To undo it, use a soldering iron on the (J09) part and connect it with the jumper lead.)

▼ Example: Indoor unit P.C. board (MCC-1643)

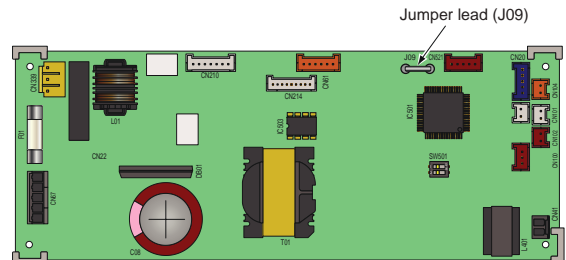

In Case 2: Wired remote controller setting

CAUTION

- Set only the CODE No. shown in the following table: Do NOT set any other CODE No. If a CODE No. not listed is set, it may not be possible to operate the air conditioner or other trouble with the product may result.

■ RBC-AMS5*E*

Perform the advanced settings for the air conditioner.
Carry out the setting operation while the indoor unit is stopped. (Turn off the air conditioning unit before starting the setting operation.)

Display example of RBC-AMS51-ES

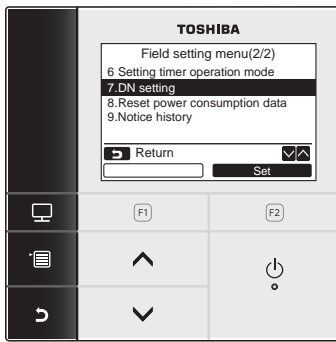

Operation procedure

- 1 Push the [MENU] button to display the menu screen.
- 2 Push and hold the [MENU] button and the [▽▽] button at the same time to display the "Field setting menu". Push and hold the buttons for more than 4 seconds.
- 3 Push the [^ ^]/[▽▽] button to select "7. DN setting" on the "Field setting menu" screen, then push the "Set" [F2] button.
Push the [^ ^]/[▽▽] button to select the "Indoor unit" and push the "Set" [F2] button.
The fan and louver of the indoor unit operate. When the group control is used, the fan and louver of the selected indoor unit operate.
- 4 Move the cursor to select "DN code" with the "<" [F1] button, then set "1A0" with the [^ ^]/[▽▽] button.
- 5 Move the cursor to select "Data" with the ">" [F2] button, then set "0001" with the [^ ^]/[▽▽] button.

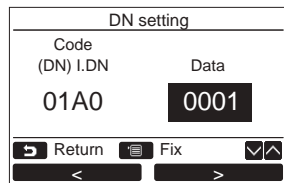
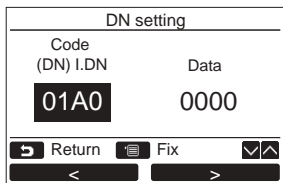
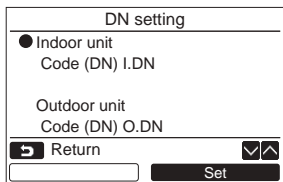

- 6 Push the [MENU] button to set the other DN codes, then "Continue?" is displayed on the screen.

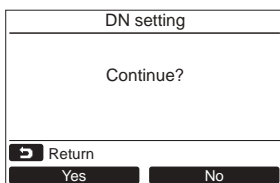

- 7 Push the "No" [F2] button to finish the setting operation. "Σ" appears on the screen for a while, then the screen returns to the "Field setting menu" screen.
Pushing the "No" [F2] button displays the unit selection screen when the group control is used. Push the [CANCEL] button on the unit selection screen to finish the setting operation. "Σ" appears on the screen for a while, then the screen returns to the "Field setting menu" screen.
- 8 Push the [CANCEL] button to return.

■ RBC-ASCU11*

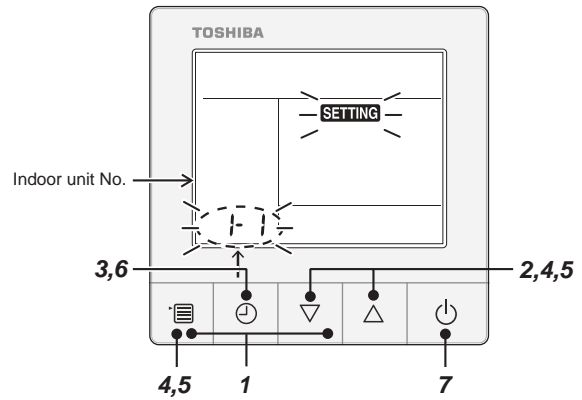

Operation procedure

- 1 Push and hold menu button and [▽] setting button simultaneously for 10 seconds or more.
• After a while, the display flashes as shown in the figure. "ALL" is displayed as indoor unit numbers during initial communication immediately after the power has been turned on.
- 2 Each time [▽][△] setting button is pushed, indoor unit numbers in the group control change cyclically. Select the indoor unit to change settings for.
• The fan of the selected indoor unit runs and the louvers start the swinging. The indoor unit can be confirmed for which to change settings.
- 3 Push OFF timer button to confirm the selected indoor unit.

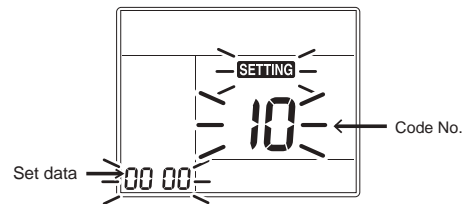

- 4 Push the menu button to make Code No. [**] flash. Change Code No. into [1A0] with [▽][△] setting button.
- 5 Push the menu button to make Set data [***] flash. Change Set data into [0001] with [▽][△] setting button.

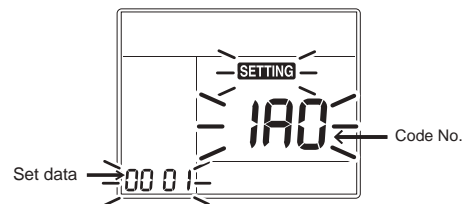

- 6 Push OFF timer button to complete the setup.
• To change other settings of the selected indoor unit, repeat from Procedure 4.
- 7 When all the settings have been completed, push ON/OFF button to finish the settings. (return to the normal mode)
"SETTING" flashes and then the display content disappears and the air conditioner enters the normal stop mode.
(The Remote controller is unavailable while "SETTING" is flashing.)
• To change settings of another indoor unit, repeat from Procedure 1.

FAN CONTROL SETUP

The high ceiling setting is necessary to change the setup value to High ceiling (3) when installing Air purifier kit.

Follow to the basic operation procedure (1 → 2 → 3 → 4 → 5 → 6).

- For the CODE No. in Procedure 3, specify [5d].
- Select the SET DATA for Procedure 4 from the "Height list of ceiling possible to be installed" table in this manual.

DN, CODE No. [5D]	Data	Setup of high ceiling
	0000	Standard (Factory default)
	0003	High ceiling (3)

◆ Remote controller-less setting

Change the high-ceiling setting with the DIP switch on the receiver section P.C. board.

For details, refer to the manual of the Wireless remote controller kit. The settings can also be changed with the switch on the indoor microcomputer P.C. board.

- * Once the setting is changed, setting to 0001 or 0003 is possible, however setting to 0000 requires a setting data change to 0000 using the Wired remote controller (separately sold) with the normal switch setting (factory default).

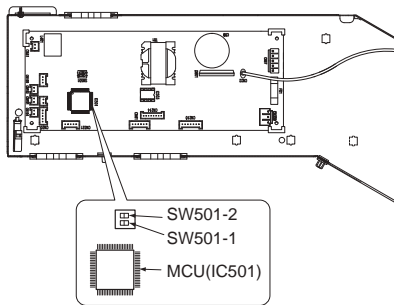

SET DATA	SW501-1	SW501-2
0000 (Factory default)	OFF	OFF
0003	OFF	ON

To restore the factory defaults

To return the DIP switch settings to the factory defaults, set SW501-1 and SW501-2 to OFF, connect a separately sold Wired remote controller, and then set the data of CODE No. [5d] to "0000".

REMOTE CONTROLLER ADDRESS (A-B SELECTION) SETTING

- When two or more Wireless receiver are installed in a room, a unique address can be set for each Wireless receiver unit to prevent interference.
- Address (A-B selection) must be changed on Wireless remote controller.

TEST RUN (FORCED COOLING OPERATION)

REQUIREMENT

- Finish the forced cooling operation in a short time because it applies excessive strength to the air conditioner.

How to perform forced cooling operation

- When TEMPORARY button is pushed for 10 seconds or more, "Pit" sound is heard and the operation changes to a forced cooling operation. After approx. 3 minutes, a cooling operation starts forcibly. Check cool air starts blowing. If the operation does not start, check wiring again.
- To stop a test operation, push TEMPORARY button once again (Approx. 1 Sec.).
 - Check wiring / piping of the indoor and outdoor unit in forced cooling operation.

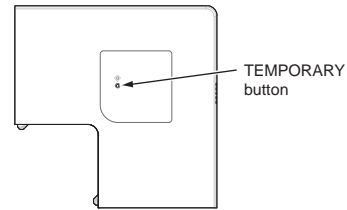

PREPARATION AND CHECK BEFORE USE

- Loading Batteries
 - Remove the battery cover.
 - Insert 2 new batteries (R03 [AAA]) following the (+) and (-) positions.
- Removing Batteries
 - Remove the battery cover.
 - Remove the 2 used batteries.

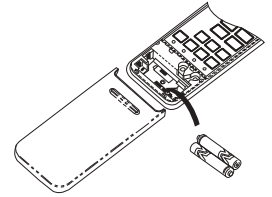

BATTERIES

- To replace the batteries, use two new batteries (R03 [AAA]).
- In normal use, the batteries will last about one year.
- Replace the batteries if there is no receiving beep from the indoor unit or when the air conditioner cannot be operated using the Remote controller.
- To avoid malfunctions by battery leakage, remove the batteries when not using the Remote controller for more than one month.
- Please dispose of the used batteries according to the local regulation.

INSTALLING THE REMOTE CONTROLLER HOLDER

- Before you actually install the remote controller holder on a wall or pillar, check whether the Remote controller signals can be received by the indoor unit.

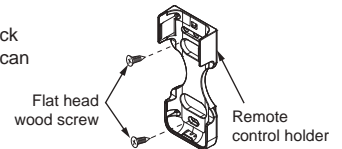

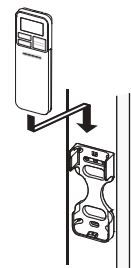

MOUNTING AND REMOVING THE REMOTE CONTROLLER

- To mount the remote controller hold it parallel to the remote controller holder and push it in fully. To remove the Remote controller slide the Remote controller upwards and out from the holder.

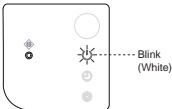
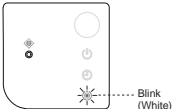
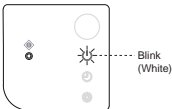
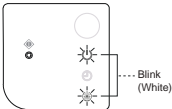
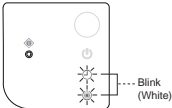
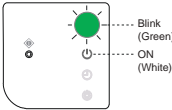
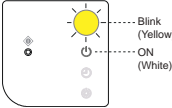

SELF-DIAGNOSIS FUNCTION AND MEASURES

- The following table shows a few examples. For details of indoor unit errors, refer to the Installation Manual of the indoor unit.

LEDs indicator	Wired remote controller display	Possible cause	Measures
 <p>These LEDs do not light or blink even if the Remote controller is operated.</p>	-	<ul style="list-style-type: none"> Power is not turned ON. Incorrect connection between signal receiving unit and indoor unit 	<ul style="list-style-type: none"> Check connections and reconnect wires correctly if necessary.
 <p>.....Blink (White)</p>	E03	<ul style="list-style-type: none"> Loose connection between signal receiving unit and indoor unit 	
 <p>.....Blink (White)</p>	E04	<ul style="list-style-type: none"> Incorrect or loose connection between indoor unit and outdoor unit 	
 <p>.....Blink (White)</p>	E11	<ul style="list-style-type: none"> Communication trouble between option P.C. board and indoor unit 	<ul style="list-style-type: none"> Check the indoor unit and option P.C. board
 <p>.....Blink (White)</p>	L03, L08, L09	<ul style="list-style-type: none"> Indoor unit centre duplicated. Indoor unit group / Address unset. Indoor unit capacity unset. 	<ul style="list-style-type: none"> Check the indoor unit.
 <p>.....Blink (White)</p>	P10, P12	<ul style="list-style-type: none"> Indoor unit overflow trouble. Indoor unit fan motor trouble. 	<ul style="list-style-type: none"> Check the indoor unit.
 <p>.....Blink (Green)ON (White)</p>	F30	<ul style="list-style-type: none"> Air purifier trouble. 	<ul style="list-style-type: none"> Check air purifier.
 <p>.....Blink (Yellow)ON (White)</p>		<ul style="list-style-type: none"> Dust sensor trouble. 	<ul style="list-style-type: none"> Check dust sensor.

LEDs on the Wireless receiver unit ○ : OFF

⦿ : Blinking (at intervals of 0.5 seconds)

● : ON

Notes on installing Remote controller

- When using a Wireless remote controller in the remote controller holder on a wall, turn on a fluorescent light and operate the Remote controller at the installation position.
- Make sure that the air conditioner operates normally and then secure the remote controller holder on the wall.
- When installing a Remote controller that senses room temperature with the sensor, avoid the following places.
 - A place exposed to direct cool air, warm air or direct sunlight.
 - A place subject to thermal effects.

Explanation to the customer

- After the installation work has been completed, execute a test run to check for normal operation and then hand the customer the Operation Manual and Installation Manual of the Air purifier kit.
- Explain how to use and maintain the Air purifier kit to the customer according to the Operation Manual of the Air purifier kit.

LIST OF SEPARATELY AVAILABLE PRODUCTS THAT CANNOT BE USED WITH THE AIR PURIFIER KIT

- The following separately available products cannot be used together with the Air purifier kit.

Product name	Model
Occupancy sensor kit	TCB-SIR33UP-E

MAINTENANCE AND CLEANING

The air purifier unit is based on the principle of collecting cigarette smoke and dust in the room to the dust collection area. After using for a certain period of time, be sure to clean each part as follows.

WARNING

- Cleaning each part involves dangerous work in high places, so be sure to have a qualified installer or qualified service person to do it. Do not attempt it by yourself.
- Before cleaning each part, stop the operation forcibly and turn off the circuit breaker to avoid electric shock.
- Especially, Dust collector and Deodorize filter cleaning shall be done after stop the operation 2 minutes at least to avoid electric shock by electrostatic discharge from Dust collector.

Air filter

- Clean every 3-6 months when dust stuck or covers the air filter.
- Clean using a vacuum cleaner or wash with water.
- When the air filter is very dirty, the dirt can be removed effectively by washing with water or lukewarm water dissolved a neutral detergent.
- Dry well in the shade after washing with water.

HOW TO DISASSEMBLE THE AIR FILTER

1. Open the air inlet grille
 - Push the corner of the air inlet grille and then slide the two hooks toward inside while pushing its corner, hold the air inlet grille and open it quietly.

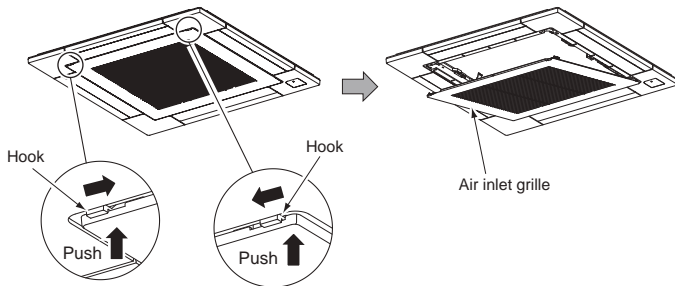

2. Remove the Air filter
 - Push the protruding section of the air filter towards the inside and pull it towards you to remove it.

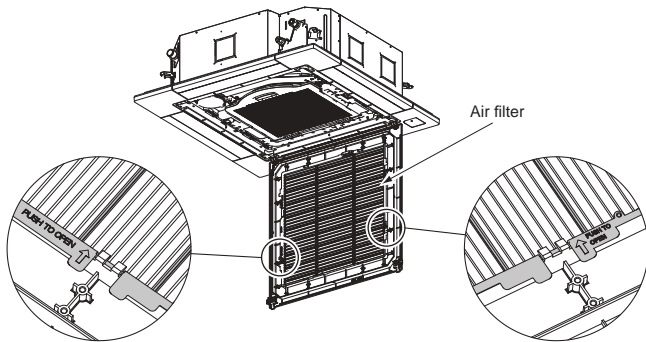

CAUTION

- Take extra care the actuator when cleaning the air filter.
- After clean the air filter then install it back to the air inlet grille, the position of the actuator that installed on the air filter must match with the sensor on the indoor unit.

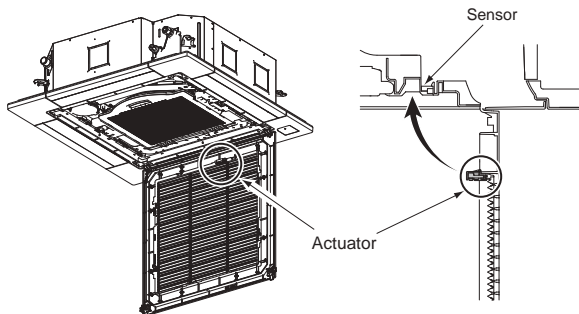

- If the actuator is not installed in the correct position, the air purifier feature will not operate.

Dust collector filter

- Clean every 6 months (assuming 8 hours of daily use) when dust stuck or covers the Dust collector filter.
- Take extra care when cleaning the Dust collector filter.
- Recommend to submerge the Dust collector filter in water then shaking it several times to clean.
- In case of getting heavy dirty on the Dust collector filter, please soak it in lukewarm water at 40°C to 50°C for about 30 minutes with mild detergent and rinse thoroughly with clean water.
- Do not use alcohol, benzine, thinner, polishing powder or chemically-treated duster for cleaning.
- Dry the Dust collector filter in the shade for about half a day or until it completely dry.

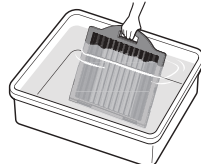

NOTE

- The cleaning frequency of the Dust collector filter depends on the level of impurities in your operation environment. Higher levels of impurities may require more frequent cleaning.

HOW TO DISASSEMBLE THE DUST COLLECTOR FILTER

1. Push hook of Main frame at handle position to unlock the Dust collector as below.

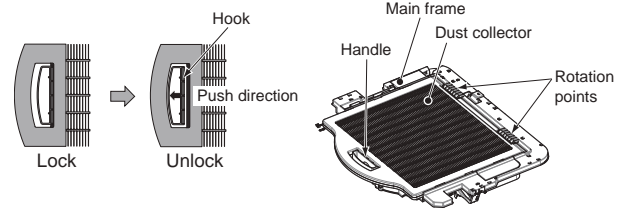

2. Rotate the Dust collector then slide it out of the Main frame follow figure as below.

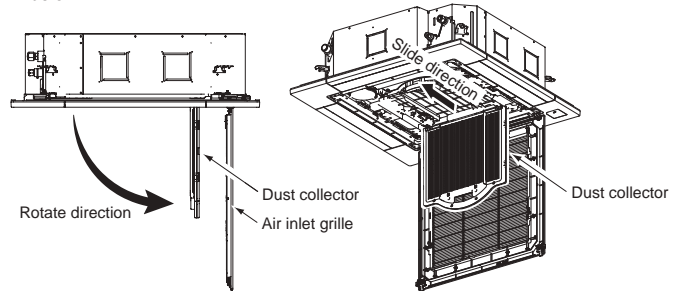

CAUTION

- Do not use brush or poke the Dust collector to remove dust as this can cause damage.
- If necessary to dry the Dust collector with the blower, it should low pressure air.
- Please make sure the Dust collector filter is completely dry before use.
- Please avoid drying the Dust collector with a hot air dryer as it may cause damage.

Deodorize filter

- Clean every 3-6 months when dust stuck or covers the Deodorize filter.
- Recommend to use vacuum to clean by sucking the dusts which stick or dip inside the Deodorize filter or use the blower to blow the dust go out through the Deodorize filter.
- If necessary to use water to clean, simply use the plain water to wash the Deodorize filter, dry with the sunlight for 3-4 hours or until it completely dry.
- Nevertheless, use hair drier to dry it. However, washing with water, it may reduce the performance of the Deodorize filter.
- Replace every 2 years or sooner. (contact your dealer to purchase new Deodorize filter)

HOW TO DISASSEMBLE THE DEODORIZE FILTER

- Slide the Deodorize filter from the Main frame follow direction shown below.

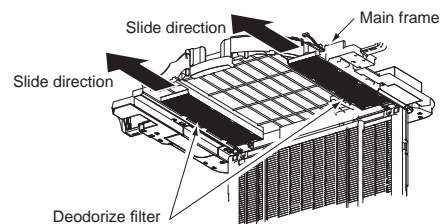

NOTE

- Deodorize filter life depends on the level of impurities in your operation environment. Higher levels of impurities may require more frequent cleaning and replacement.